

KRAFTWERK®

FAVORITE TOOLS SINCE 1979



GENERAL COLLECTION

www.kraftwerktools.com

KRAFTWERK®

FAVORITE TOOLS SINCE 1979

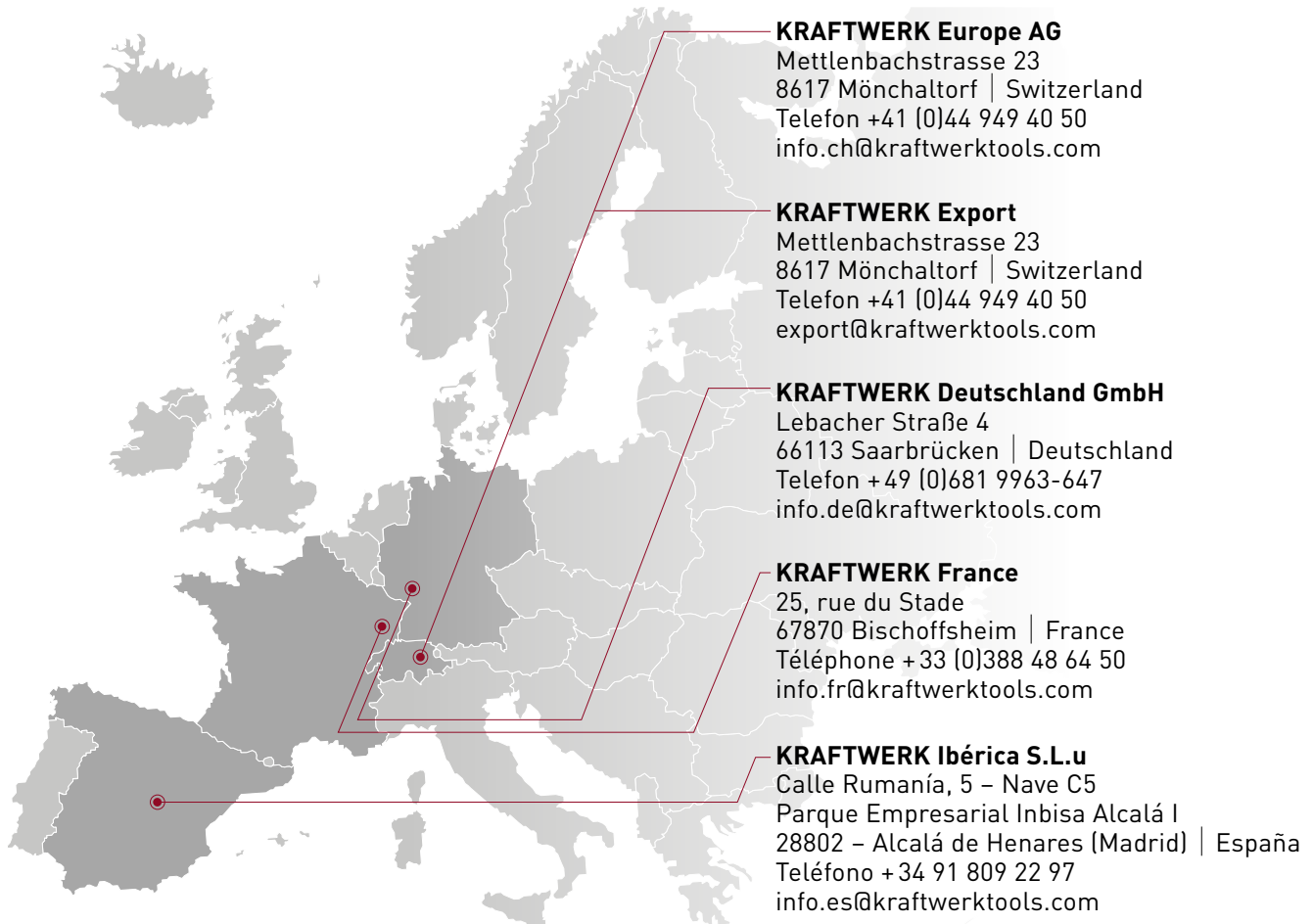

KRAFTWERK Europe AG

Mettlenbachstrasse 23
8617 Mönchaltorf | Switzerland
Telefon +41 (0)44 949 40 50
info.ch@kraftwerktools.com

KRAFTWERK Export

Mettlenbachstrasse 23
8617 Mönchaltorf | Switzerland
Telefon +41 (0)44 949 40 50
export@kraftwerktools.com

KRAFTWERK Deutschland GmbH

Lebacher Straße 4
66113 Saarbrücken | Deutschland
Telefon +49 (0)681 9963-647
info.de@kraftwerktools.com

KRAFTWERK France

25, rue du Stade
67870 Bischofsheim | France
Téléphone +33 (0)388 48 64 50
info.fr@kraftwerktools.com

KRAFTWERK Ibérica S.L.u

Calle Rumanía, 5 – Nave C5
Parque Empresarial Inbisa Alcalá I
28802 – Alcalá de Henares (Madrid) | España
Teléfono +34 91 809 22 97
info.es@kraftwerktools.com

Folgen Sie uns
Suivez-nous
Seguici



facebook.com/kraftwerktools



youtube.com/kraftwerktools



#kraftwerktools

www.kraftwerktools.com



5-103

1



105-217

2



219-255

3



257-327

4



329-369

5



371-385

6



387-399

7



401-409

8



411-433

9



ABS-Arbeitsabdeckung mit Ablagefächern **beständig gegen Chemikalien**.

Plateau de travail ABS avec casiers, résistant aux produits chimiques.

Ripiano di lavoro in **ABS** con vani portaoggetti, **resistente ai prodotti chimici**.

1



Einfingerbedienbare und federleichtgängige, kugelgelagerte **Vollauszug-Schubladen**, herausnehmbar.

Ouverture totale facilitée du tiroir- mécanisme à roulement - tiroir extractible.

Cassetti estraibili, montati su guide con cuscinetti a sfera per un preciso e morbido scorrimento e con **apertura totale**.

2

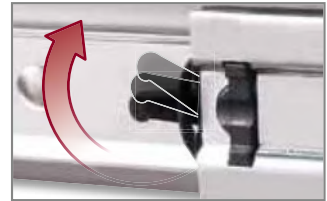

Einhand-Einzelschubladenverriegelung unter der Griffblende; auch während der Fahrt bleiben die Schubladen sicher arretiert.

Verrouillage de chaque tiroir sous la poignée d'ouverture; même durant le déplacement de la servante les tiroirs restent fermés.

Con leva di bloccaggio sui singoli cassetti; anche durante uno spostamento i cassetti rimangono chiusi.

3

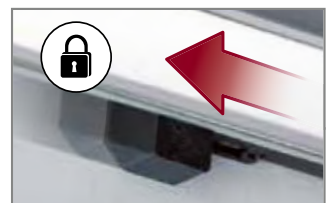

Vielältiges Zubehör zum direkten Anbau an die stabile Doppelwandkonstruktion der Werkstattwagen.

Large gamme d'accessoires pour un montage direct sur la structure très robuste à double paroi de la servante d'atelier.

Vasta gamma di accessori da fissare a lato del robusto telaio, realizzato in doppia lamiera.

4

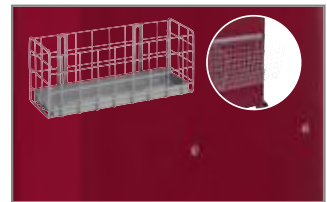

Auszugsgriffleiste mit Führung für **individuelle Inhaltsbeschriftung**.

Porte étiquette plexi amovible en façade du tiroir pour indication individuelle du contenu.

Porta etichette sul frontale del cassetto per una **immediata individuazione del contenuto**.

5



Offene Schubladen können auch bei geschlossenem Wagen in den Wagenkörper zurückgeschoben werden.

Système de fermeture centralisée : même lorsque la servante est verrouillée les tiroirs ouverts peuvent être refermés.

Sistema di chiusura centralizzata: i cassetti ancora aperti si possono chiudere anche dopo quando il carrello è già stato chiuso.

6



Kugelgelagerte Hochleistungsräder für optimales Manövrieren. Lenkrollen mit Rollenbremse.

Roues sur roulement à billes haute performance pour maniabilité optimale. 2 roues pivotantes avec freins.

Ruote girevoli dotate di sistema frenante e con **cuscinetti a sfera** per un'ottimale facilità di manovra.

7





Werkstattwagen
Servante d'atelier
Carrello porta utensili

Art.	
3907-1	6

	L1 / mm	L2 / mm	L3 / mm	⚖ kg
	646	483	973	215
Top	646	483	25	50
A	533	414	70	25
B	533	414	110	30
C	533	414	230	30



Werkstattwagen
Servante d'atelier
Carrello porta utensili

Art.	
3908	8

	L1 / mm	L2 / mm	L3 / mm	⚖ kg
	646	483	973	265
Top	646	483	25	50
A	533	414	60	25
B	533	414	110	30



Werkzeugkoffer zu Werkstattwagen

Coffre pour servantes

Cassetiera aggiuntiva per carrelli

Art.	
3905	4

	L1 / mm	L2 / mm	L3 / mm	kg
	646	483	973	130
Top	646	483	25	30
A	533	414	48	20
B	533	414	70	25
C	533	414	110	30

Passend zu
S'adapte sur
Compatibile con



3907-1



3908



EXTRA LARGO

Rollende Werkbank / extra langer Werkstattwagen

- mit 12 kugelgelagerten, einzel verriegelbaren Vollauszug-Schubladen, 9 davon ideal passend für 27 COMPLETETO-Werkzeug-Einlagen
- Fach mit Türe und 2 Verstellböden
- Zentralverriegelung
- 25 mm dicke Multiplex-Platte, made in Germany
- 4 PP-Industrie-Räder, 2 fix und 2 lenkbar, je mit Rollenbremse
- Tragkraft: 30-35 kg pro Schublade
- Statische Tragkraft: 450-500 kg.

EXTRA LARGO

Etabli roulant / servante d'atelier extra-longue

- Avec 12 tiroirs à ouverture totale, sur glissières à roulements à billes et verrouillage individuel de chaque tiroir, dont 9 sont idéalement adaptés pour intégrer 27 coquilles COMPLETETO
- Compartiment avec porte et 2 étagères réglables
- Verrouillage centralisé
- Plateau multiplex de 25 mm d'épaisseur, made in Germany
- 4 roues PP industrielles avec frein, 2 fixes et 2 orientables
- Capacité: 30-35 kg par tiroir
- Capacité de charge statique: 450-500 kg.



EXTRA LARGO

Banco da lavoro rotabile / carrello per officina extra lungo

- con 12 cassetti montati su guide con cuscinetti a sfera e con apertura totale, 9 cassetti idealmente adatti per 27 vaschette COMPLETETO
- Compartimento con sportello e 2 scaffali regolabili
- Sistema di chiusura centralizzata
- Tavola multistrato da 25 mm di spessore, made in Germany
- 4 ruote in PP industriale, 2 fisse e 2 orientabili, tutte con freno
- Capacità: 30-35 kg per cassetto
- Capacità portata statica: 450-500 kg.

Art.	kg
3936	10

	L1 / mm	L2 / mm	L3 / mm	kg
	1800	459	25	580
Top	1800	459	25	200
A	568	413	66	30
B	568	413	145	30
C	568	413	224	30
D	459	454	638	30
Shelf	459	454	638	10



Service-Werkstattwagen

mit grossem Werkzeugfach, Deckel sanft hebend und schliessend dank Gasdruckfedern, 3 kugelgelagerte Schubladen, grosses Bodenfach.

Servante d'atelier

avec grand compartiment, 3 tiroirs sur roulement à ouverture et fermeture douces grâce au ralentisseur à gaz, grand compartiment inférieur.

Carrello di servizio

con grande compartimento, lieve apertura e chiusura grazie a sospensioni a gas, 3 cassetti su cuscinetti, grande compartimento inferiore.

Art.				
3917	3			
	L1 / mm	L2 / mm	L3 / mm	kg
	792	445	960	160
A	690	410	104	40
B	650	355	45	20
C	650	355	68	30
D	650	355	100	30
E	768	410	65	40

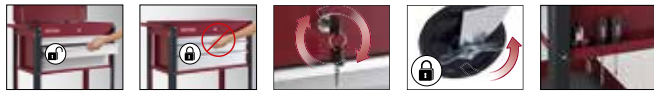

Werkstattwagen

ohne Werkzeuge

Servante

sans outils

Carrello

senza utensili

Art.	3934			
	L1 / mm	L2 / mm	L3 / mm	kg
	688	482	1013	235
Top	688	482	25	50
A	531	407	65	25
B	531	407	145	30



MDF-Deckplatte

zu Werkstattwagen 3934

Plateau MDF

pour servante 3934

Pannello in MDF

per carrello 3934

Art.	3934-99
------	----------------

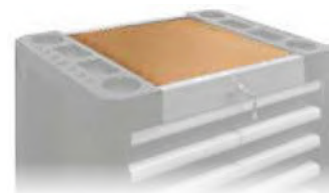

432 x 428 x 16 mm

Werkstattwagen

ohne Werkzeuge

Servante

sans outils

Carrello

senza utensili

Art.				
3935				
	L1 / mm	L2 / mm	L3 / mm	⚖️ kg
	1044	482	1013	235
Top	1044	482	25	50
A	886	407	65	25
B	886	407	145	30



MDF-Deckplatte

zu Werkstattwagen 3935

Plateau MDF

pour servante 3935

Pannello in MDF

per carrello 3935

Art.	
3935-99	

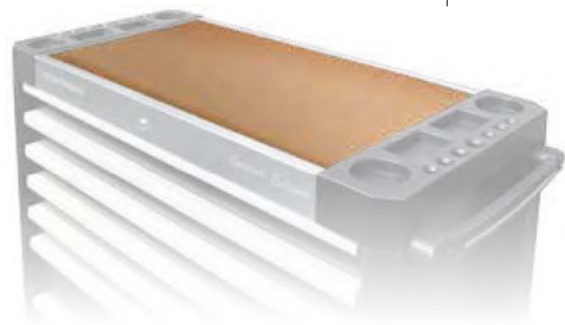

↕ 788 x 428 x 16 mm

Werkstattwagen

mit kugelgelagerten und einzeln verriegelbaren Vollauszug-Schubladen mit Zentralverschluss.

Servante

avec tiroirs à roulement, ouverture totale, verrouillage de chaque tiroir, fermeture centralisée.

Carrello porta utensili

con cassette completamente estraibili dotati di guide su cuscinetti a sfera, blocco del singolo cassetto e chiusura centralizzata con serratura.

Art.				
2905		5		
	L1 / mm	L2 / mm	L3 / mm	⚖️ kg
	695	475	1012	200
Top	533	408	25	50
A	536	410	60	25
B	536	410	124	30
C	536	410	172	30



Werkstattwagen

mit kugelgelagerten und einzeln verriegelbaren Vollauszug-Schubladen mit Zentralverschluss.

Servante

avec tiroirs à roulement, ouverture totale, verrouillage de chaque tiroir, fermeture centralisée.

Carrello porta utensili

con cassetti completamente estraibili dotati di guide su cuscinetti a sfera, blocco del singolo cassetto e chiusura centralizzata con serratura.

Art.	
2907	7

	L1 / mm	L2 / mm	L3 / mm	kg
	695	475	885	240
Top	533	408	25	50
A	536	410	45	25
B	536	410	60	30
C	536	410	172	30



Werkzeugkoffer zu Werkstattwagen

mit kugelgelagerten und einzeln verriegelbaren Vollauszug-Schubladen mit Zentralverschluss.

Coffre pour servantes

avec tiroirs à roulement, ouverture totale, verrouillage de chaque tiroir, fermeture centralisée.

Cassettiera portatile per carrelli

con cassetti completamente estraibili dotati di guide su cuscinetti a sfera, blocco del singolo cassetto e chiusura centralizzata con serratura.

Art.	
2904	3

	L1 / mm	L2 / mm	L3 / mm	kg
	695	475	345	115
Top	533	408	25	30
A	536	410	60	25



Passend zu
S'adapte sur
Compatibile con



Schubladen-Gummi-Antirutschmatte
Tapis caoutchouc antidérapant pour tiroirs
Tappetino in gomma antiscivolo per cassetti

Art.	
3918	3907-1 / 3908 / 3905 3934 / 2905 / 2907 / 2904

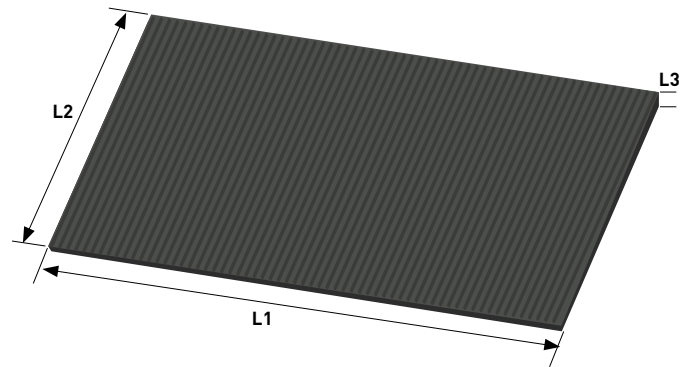

↕ L1 530 × L2 405 × L3 2 mm

Schubladen-Unterteiler-Einsatz
aus verzinktem Stahlblech
Insert de séparation „U“ pour tiroirs
en acier zingué
Separatore ad „U“ per cassetti
in lamiera d'acciaio zincata

Art.	
3919	3907-1 / 3908 / 3905

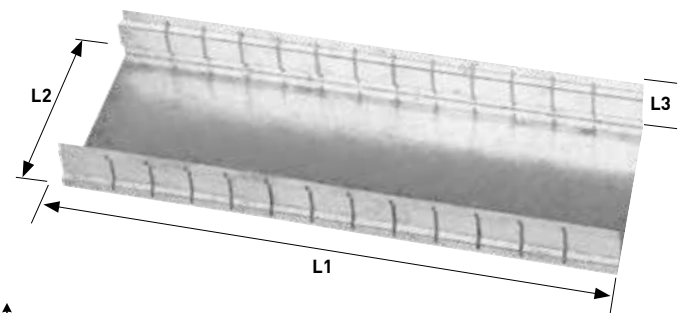

↕ L1 409 × L2 132 × L3 50 mm

Fach-Unterteiler
zu 3919, aus verzinktem Stahlblech
Séparation
pour 3919, en acier zingué
Separatori per cassetti
per 3919, in lamiera d'acciaio zincata

Art.	
3920	3907-1 / 3908 / 3905

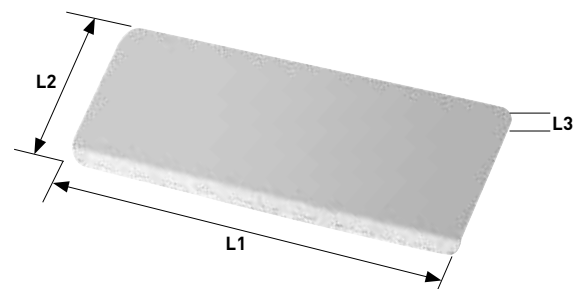

↕ L1 129 × L2 50 × L3 1.2 mm

Schubladeneinlage, flach
Compartment de tiroirs plat
Vaschetta piana per cassetti

Art.	
3921	3907-1 / 3908 / 3905 / 3934 2905 / 2907 / 2904

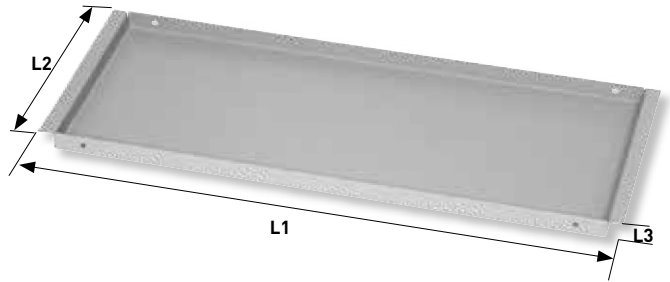

↕ L1 530 × L2 200 × L3 20 mm

Schubladeneinlage, tief
Compartment de tiroirs creux
Vaschetta profonda per cassetti

Art.	
3922	3907-1 / 3908 / 3905 2905 / 2907 / 2904

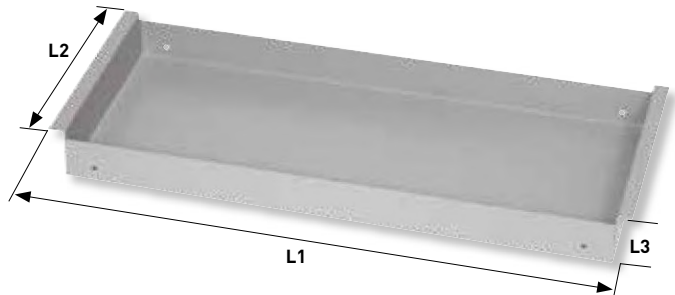

↕ L1 530 × L2 200 × L3 45 mm

Aussenkorb
mit Einlegewanne
Corbeille extérieure
avec bac

Cestino esterno
con salvagoccia

Art.	
3923	3907-1 / 3908

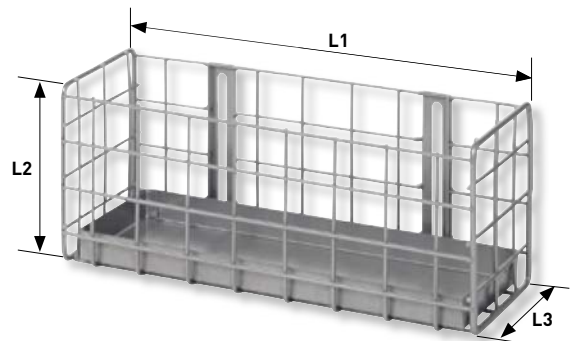

↕ L1 280 × L2 115 × L3 95 mm

Universalkorb
mit Halter

Dévidoir
avec support

Cestino universale
dotato di ganci

Art.	
3924	3907-1 / 3908

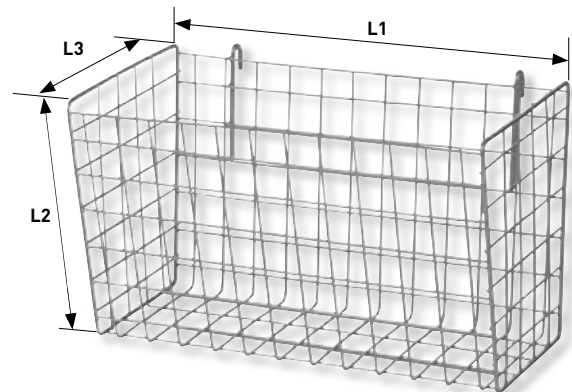
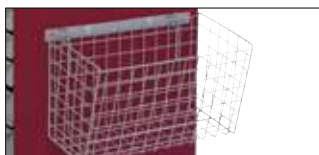

↕ L1 365 × L2 220 × L3 215 mm

Halterung für Reinigungstuch-Rollen
Support de rouleau d'essuyage
Supporto portarotolo

Art.	
3925	3907-1 / 3908

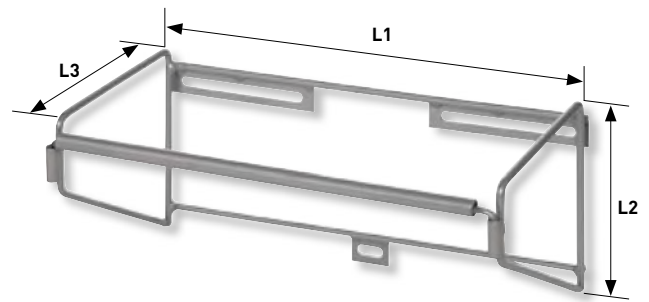

↕ L1 330 × L2 175 × L3 140 mm

Seitentisch

mit integriertem Rollenhalter für den Gebrauch eines Notebooks oder als zusätzliche Abstellfläche.

Table latérale

avec porte-rouleau intégré facilitant l'usage d'un ordinateur ou permettant tout simplement de bénéficier d'un espace de travail supplémentaire.

Tavolino laterale

con portarotolo integrato per l'utilizzo di notebook o semplicemente come spazio di lavoro aggiuntivo.

Art.	
3927	3907-1 / 3908



↕ L1 385 × L2 380 × L3 375 mm

Kleinteile-Schalensatz zu 4920

Jeu de coquilles pour petites pièces pour 4920

Set di vaschette portaminuteria per 4920

Art.	
3936ES	3936



9
PCS



↕ 405 x 45 x 42 mm

Seitentisch

zum Gebrauch eines Notebooks oder für Dokumentenablage.

Table latérale

permettant l'usage d'un ordinateur ou le dépôt de documents.

Tavolino laterale

per l'utilizzo di notebook o semplicemente come spazio di lavoro aggiuntivo.

Art.	
1927	2905 / 2907



↕ L1 280 × L2 210 mm

Magnetteller

rostfrei

Cupelle magnétique

en inox

Vassoio magnetico

in inox

Art.	
2950	1200 g



↕ Ø 150 × 40 × 40 mm

Magnetteller

rostfrei

Cupelle magnétique

en inox

Vassoio magnetico

in inox

Art.	
2951	2 × 1200 g



↕ 240 × 140 × 40 mm

Magnetischer Werkzeughalter für Stecknüsse und Druckluftwerkzeuge

Support magnétique
pour douilles et outils pneumatiques

Supporto magnetico
per bussole ed utensili pneumatici

Art.

3929



↔ L 400 x 130 x 150 mm

Werkstattwagen-Schutzdecke Housse de protection pour servantes Telo protezione per carrello

Art.

3930 3907-1 / 3908 / 3934 / 2905 / 2907



↔ 73 x 55 x 89 mm

Hochwertige Qualität Modulares Werkstatt-Schrank-System

Haute qualité
Système de rangement modulaire d'atelier

Alta qualità
Arredamento modulare per l'officina

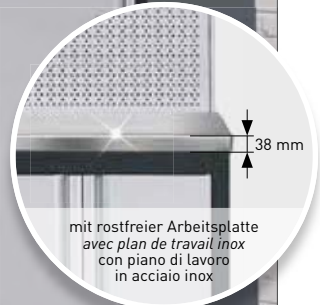
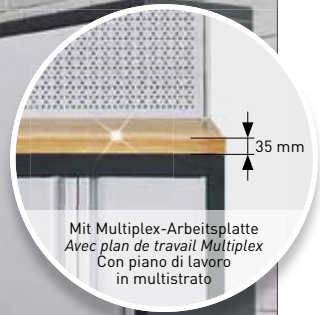

100% Compatible
COMPLETO SERIE 4900
COMPLETO EVA SERIE 4902
COMPLETO EVA3 SERIE 4903

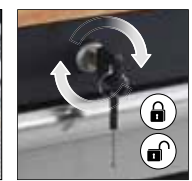

Modulares Element- Werkstatt-Schrank- wand-System

zum Zusammenstellen nach eigenem Bedarf. Freistehende Konstruktion, keine Befestigungen notwendig und daher sehr flexibel aufstellbar. Jedes Modul einzeln bestellbar. Kugelgelagerte Schubladen in verschiedenen Höhen, passend für alle KRAFTWERK Werkzeugeinlagen (COMPLETO Hartschalen, EVA, EVA3) mit Zentralverriegelung und einzeln verriegelbar. Werkzeug-Lochwände mit Euro-Norm-Lochung.

Système de rangement modulaire d'atelier

pour un assemblage personnalisable en fonction des besoins. Construction autoportante ne nécessitant ni support mural ni fixations, très facile à installer. Chaque module peut être commandé individuellement. Tiroirs sur roulements à billes avec différentes hauteurs, adaptés à tous les inserts d'outils KRAFTWERK (COMPLETO ABS, EVA, EVA3) avec verrouillage centralisé et individuel. Parois porte-outils perforées Euro standard.

Arredamento modulare per l'officina

per comporre lo spazio secondo proprie esigenze. Costruzione autoportante, non necessita di attacchi nè di muri di sostegno per una installazione facile e flessibile. Ogni modulo può essere ordinato individualmente. Cassetti su cuscinetti a sfera, disponibili in varie altezze, compatibili con i moduli portautensili KRAFTWERK (COMPLETO ABS, EVA, EVA3) con chiusura centralizzata e individuale. Parete portautensili forata Euro-Standard.



3-Element- Werkstatt-Schrankwand

- 2 Oberschränke mit Gasfederung
- 1 Hochschrank mit 4 Tablaren
- 1 Schrankmöbel, 2-türig mit 1 Tablar
- 1 Schubladenschrank mit 5 Schubladen
- 2 Werkzeug-Lochwände
- 1 Arbeitsplatte

Meuble 3 éléments

- 2 meubles hauts avec vérins
- 1 armoire avec 4 tablettes
- 1 meuble bas, 2 portes avec 1 tablette
- 1 meuble bas, 5 tiroirs
- 2 panneaux perforés
- 1 plan de travail

Parete da officina da 3 elementi

- 2 armadi a parete con sportello
ammortizzato a gas
- 1 armadio alto con 4 ripiani
- 1 armadio a due ante con 1 ripiano
- 1 armadio a 5 cassetti
- 2 pareti forate
- 1 piano di lavoro

Art.	
3964A	Mit Multiplex-Arbeitsplatte <i>Avec plan de travail Multiplex</i> Con piano di lavoro in multistrato 1361 x 463 x 35 mm
3964AIX	Mit rostfreier Arbeitsplatte <i>Avec plan de travail inox</i> Con piano di lavoro acciaio inox 1361 x 463 x 38 mm



4-Element- Werkstatt-Schrankwand

- 3 Oberschränke mit Gasfederung
- 1 Hochschrank mit 4 Tablaren
- 1 Schrankmöbel, 2-türig mit 1 Tablar
- 1 Schubladenschrank mit 4 Schubladen
- 1 Schubladenschrank mit 5 Schubladen
- 3 Werkzeug-Lochwände
- 1 Arbeitsplatte

Meuble 4 éléments

- 3 meubles hauts avec vérins
- 1 armoire avec 4 tablettes
- 1 meuble bas, 2 portes avec 1 tablette
- 1 meuble bas, 4 tiroirs
- 1 meuble bas, 5 tiroirs
- 3 panneaux perforés
- 1 plan de travail

Parete da officina da 4 elementi

- 3 armadi a parete con sportello ammortizzato a gas
- 1 armadio alto con 4 ripiani
- 1 armadio a due ante con 1 ripiano
- 1 armadio a 4 cassetti
- 1 armadio a 5 cassetti
- 3 pareti forate
- 1 piano di lavoro

Art.	
3964B	Mit Multiplex-Arbeitsplatte Avec plan de travail Multiplex Con piano di lavoro in multistrato 2041 x 463 x 35 mm
3964BIX	Mit rostfreier Arbeitsplatte Avec plan de travail inox Con piano di lavoro acciaio inox 2041.5 x 463 x 38 mm



4-Element- Werkstatt-Schrankwand

- 3 Oberschränke mit Gasfederung
- 1 Hochschrank, 2-türig mit 4 Tablaren
- 1 Schubladenschrank mit 9 Schubladen
- 1 Roll-Schubladenschrank mit 7 Schubladen
- 1 Unterschrank mit Abfalleimer/ Papierhalter
- 3 Werkzeug-Lochwände
- 1 Arbeitsplatte

Meuble 4 éléments

- 3 meubles hauts avec vérins
- 1 armoire 2 portes avec 4 tablettes
- 1 meuble bas, 9 tiroirs
- 1 meuble bas à roulettes, 7 tiroirs
- 1 meuble bas avec poubelle intégrée et support pour rouleau essuie-tout
- 3 panneaux perforés
- 1 plan de travail

Parete da officina da 4 elementi

- 3 armadi a parete con sportello ammortizzato a gas
- 1 armadio alto a due ante con 4 ripiani
- 1 armadio a 9 cassetti
- 1 armadio con ruote a 7 cassetti
- 1 armadio con secchio della spazzatura e supporto per rotolo carta integrato
- 3 pareti forate
- 1 piano di lavoro

Art.	
3964D	Mit Multiplex-Arbeitsplatte Avec plan de travail Multiplex Con piano di lavoro in multistrato 2041 x 463 x 35 mm
3964DIX	Mit rostfreier Arbeitsplatte Avec plan de travail inox Con piano di lavoro acciaio inox 2041.5 x 463 x 38 mm



8-Element- Werkstatt-Schrankwand

- 5 Oberschränke mit Rolläden
- 1 Eck-Oberschrank mit Gasfederung
- 1 Hochschrank mit 4 Tablaren
- 1 Hochschrank, 2-türig mit 4 Tablaren
- 1 Schrankmöbel, 2-türig mit 1 Tablar
- 1 Eck-Schrankmöbel mit 1 Türe
- 1 Schubladenschrank mit 8 Schubladen
- 1 Schubladenschrank mit 4 Schubladen
- 1 Roll-Schubladenschrank mit 7 Schubladen
- 1 Unterschrank mit Abfalleimer/
Papierhalter
- 4 Werkzeug-Lochwände
- 2 Werkzeug-Lochwände zu 3964-16
- 3 Arbeitsplatten

Meuble 8 éléments

- 5 meubles hauts avec vérins
- 1 meuble haut d'angle avec vérins
- 1 armoire avec 4 tablettes
- 1 armoire 2 portes avec 4 tablettes
- 1 meuble bas, 2 portes avec 1 tablette
- 1 meuble d'angle bas à 1 porte
- 1 meuble bas, 8 tiroirs
- 1 meuble bas, 4 tiroirs
- 1 meuble bas à roulettes, 7 tiroirs
- 1 meuble bas avec poubelle intégrée
et support pour rouleau essuie-tout
- 4 panneaux perforés
- 2 panneaux perforés pour 3964-16
- 3 plans de travail

Parete da officina da 8 elementi

- 5 armadi a parete con sportello a serranda
- 1 armadio a parete ad angolo con sportello ammortizzato a gas
- 1 armadio alto con 4 ripiani
- 1 armadio alto a due ante con 4 ripiani
- 1 armadio a due ante con 1 ripiano
- 1 armadio ad angolo
- 1 armadio a 8 cassetti
- 1 armadio a 4 cassetti
- 1 armadio con ruote a 7 cassetti
- 1 armadio con secchio della spazzatura e supporto per rotolo carta integrato
- 4 pareti forate
- 2 pareti forate per 3964-16
- 3 piani di lavoro

Art.	
3964E	Mit Multiplex-Arbeitsplatte <i>Avec plan de travail Multiplex</i> Con piano di lavoro in multistrato 864 x 864 x 35 mm 1361 x 463 x 35 mm 2041 x 463 x 35 mm
3964EIX	Mit rostfreier Arbeitsplatte <i>Avec plan de travail inox</i> Con piano di lavoro acciaio inox 865 x 865 x 38 mm 1361 x 463 x 38 mm 2041.5 x 463 x 38 mm



6-Element- Werkstatt-Schrankwand

- 4 Oberschränke mit Gasfederung
- 2 Hochschränke mit 4 Tablaren
- 1 Schrankmöbel, 2-türig mit 1 Tablar
- 1 Schubladenschrank mit 4 Schubladen
- 1 Schubladenschrank mit 5 Schubladen
- 1 Schubladenschrank mit 9 Schubladen
- 4 Werkzeug-Lochwände
- 2 Arbeitsplatten

Meuble 6 éléments

- 4 meubles hauts avec vérins
- 2 armoires avec 4 tablettes
- 1 meuble bas, 2 portes avec 1 tablette
- 1 meuble bas, 4 tiroirs
- 1 meuble bas, 5 tiroirs
- 1 meuble bas, 9 tiroirs
- 4 panneaux perforés
- 2 plans de travail

Parete da officina da 6 elementi

- 4 armadi a parete con sportello
ammortizzato a gas
- 2 armadi alti con 4 ripiani
- 1 armadio a due ante con 1 ripiano
- 1 armadio a 4 cassetti
- 1 armadio a 5 cassetti
- 1 armadio a 9 cassetti
- 4 pareti forate
- 2 piani di lavoro

Art.

3964F

Mit Multiplex-Arbeitsplatte
Avec plan de travail Multiplex
Con piano di lavoro in multistrato
2x 1361 x 463 x 35 mm

3964FIX

Mit rostfreier Arbeitsplatte
Avec plan de travail inox
Con piano di lavoro acciaio inox
2x 1361 x 463 x 38 mm

Hochschrank

mit 4 Tablaren

Armoire

avec 4 tablettes

Armadio alto

con 4 ripiani

Art.	 kg
3964-02	40

 600 × 458 × 2000 mm



Tablar

zu 3964-02

Tablette

pour 3964-02

Ripiano

per 3964-02

Art.	 kg
3964-02-07	40

 590 × 430 × 20 mm



Flügeltürschrank

mit 4 Tablaren

Armoire

à portes battantes avec 4 tablettes

Armadio alto

a due ante con 4 ripiani

Art.	 kg
3964-12	40

 915 × 458 × 2000 mm



Tablar

zu 3964-12

Tablette

pour 3964-12

Ripiano

per 3964-12

Art.	 kg
3964-12-01	40

 905 × 430 × 20 mm



Schrankmöbel

mit 2 Türen und 1 Tablar

Meuble bas

avec 2 portes avec 1 tablette

Armadio

a due ante con 1 ripiano

Art.	⚖ kg
3964-03	40

↔ 600 × 458 × 910 mm



Schubladenschrank

mit 4 Schubladen

Meuble bas

avec 4 tiroirs

Armadio base

con 4 cassetti

Art.
3964-04

	L1 / mm	L2 / mm	L3 / mm	⚖ kg
	680	458	910	115
A	560	404	58	25
B	560	404	138	30
C	560	404	207	30



Schubladenschrank

mit 5 Schubladen

Meuble bas

avec 5 tiroirs

Armadio base

con 5 cassetti

Art.
3964-05

	L1 / mm	L2 / mm	L3 / mm	⚖ kg
	680	458	910	145
A	560	404	58	25
B	560	404	138	30



Schubladenschrank

mit 8 Schubladen

Meuble bas

avec 8 tiroirs

Armadio base

con 8 cassetti

Art.
3964-14

	L1 / mm	L2 / mm	L3 / mm	⚖ kg
	680	458	910	235
A	560	404	58	25
B	560	404	138	30

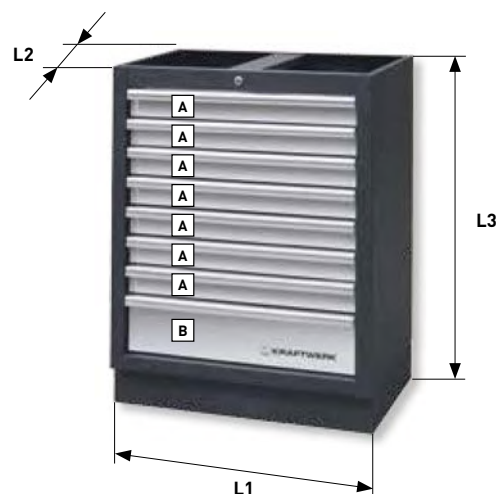

Schubladenschrank

mit 9 Schubladen

Meuble bas

avec 9 tiroirs

Armadio base

con 9 cassetti

Art.	
3964-13	

	L1 / mm	L2 / mm	L3 / mm	kg
	680	458	910	225
A	560	404	58	25



Roll-Schubladenschrank

mit 7 Schubladen

Meuble bas

à roulettes avec 7 tiroirs

Armadio

con ruote a 7 cassetti

Art.	
3964-15	

	L1 / mm	L2 / mm	L3 / mm	kg
	646	458	862	230
Top	646	458	-	50
A	527	404	58	25
B	527	404	138	30



Unterschrank

mit integriertem Abfalleimer und Halterung für Putzrollen

Meuble bas

avec poubelle intégrée et support pour rouleau essuie-tout

Armadietto base

con pattumiera e supporto per rotoli di carta

Art.	
3964-11	



↕ 680 × 458 × 910 mm

Eck-Schrankmöbel

mit 1 Tablar

Meuble d'angle bas

avec 1 tablette

Armadietto angolare

con 1 ripiano



↕ 860 × 450 mm

Art.	kg
3964-16	30

↕ 864 × 864 × 910 mm



Oberschrank

mit Gasfederung

Meuble haut

avec vérins

Armadi a parete

con sportello ammortizzato a gas

Art.	kg
3964-01	15



680 × 281 × 350 mm

Oberschrank

mit Rollläden

Meuble haut

à rideau

Armadi a parete

con sportello a serranda

Art.	kg
3964-19	15



680 × 281 × 350 mm

Eck-Oberschrank

mit Gasfederung

Meuble haut d'angle

avec vérins

Armadio a parete ad angolo

con sportello ammortizzato a gas

Art.	kg
3964-25	20



865 × 865 × 350 mm



Werkzeug-Lochwand

zu 3964-16

Panneau perforé mural

pour 3964-16

Pannello forato

per 3964-16

Art.
3964-17

1052 × 798 × 25 mm



Werkzeug-Lochwand

Panneau perforé

Pannello forato

Art.

3964-06

↕ 1052 × 614.5 × 25 mm



Verbindungsstange

für Verbindungen von zwei Elementen

Barre de raccordement

pour jonction entre 2 éléments

Supporto

per connessione di 2 elementi

Art.

3964-24

↕ 1420 × 65 × 30 mm



Verbindungsstange

für Verbindungen von zwei Elementen mit Kabelöffnung

Barre de raccordement

pour jonction entre 2 éléments avec passage de câbles

Supporto

per connessione di 2 elementi con fori per cavi

Art.

3964-07

↕ 1420 × 65 × 30 mm



Verbindungsstange für Aussenrahmen

Barre de raccordement pour structure externe

Supporto per connessione telaio esterno

Art.

3964-10

↕ 1420 × 32.5 × 30 mm



Multiplex-Arbeitsplatte

für 1 Element

Plan de travail Multiplex

pour 1 élément

Piano di lavoro in multistrato

per 1 elemento

Art.

3964-08



↕ 680 × 463 × 35 mm

Multiplex-Arbeitsplatte

für 2 Elemente

Plan de travail Multiplex

pour 2 éléments

Piano di lavoro in multistrato

per 2 elementi

Art.

3964-09



↕ 1361 × 463 × 35 mm

Multiplex-Arbeitsplatte

für 3 Elemente

Plan de travail Multiplex

pour 3 éléments

Piano di lavoro in multistrato

per 3 elementi

Art.

3964-18



↕ 2041 × 463 × 35 mm

Multiplex-Arbeitsplatte

zu 3964-16

Plan de travail Multiplex

pour 3964-16

Piano di lavoro in multistrato

per 3964-16

Art.

3964-16-99



↕ 864 × 864 × 35 mm

Rostfreie Arbeitsplatte

für 1 Element

Plan de travail inox

pour 1 élément

Piano di lavoro in acciaio inossidabile

per 1 elemento

Art.

3964-20

↕ 680 × 463 × 38 mm

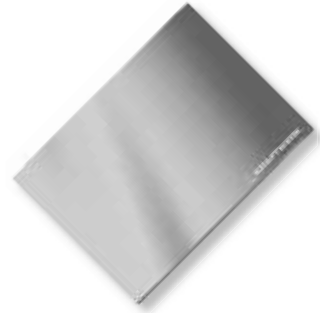

Rostfreie Arbeitsplatte

für 2 Elemente

Plan de travail inox

pour 2 éléments

Piano di lavoro in acciaio inossidabile

per 2 elementi

Art.

3964-21

↕ 1361 × 463 × 38 mm



Rostfreie Arbeitsplatte

für 3 Elemente

Plan de travail inox

pour 3 éléments

Piano di lavoro in acciaio inossidabile

per 3 elementi

Art.

3964-22

↕ 2041.5 × 463 × 38 mm



Rostfreie Arbeitsplatte

zu 3964-16

Plan de travail inox

pour 3964-16

Piano di lavoro in acciaio inossidabile

per 3964-16

Art.

3964-23

↕ 865 × 865 × 38 mm



Spitz-Haken
Crochet pointu
Gancio

Art.	L
90359	150 mm
90354	100 mm

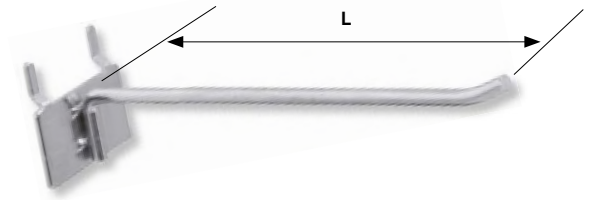

Spitz-Haken
Crochet pointu
Gancio corto

Art.	L
90377	60 mm

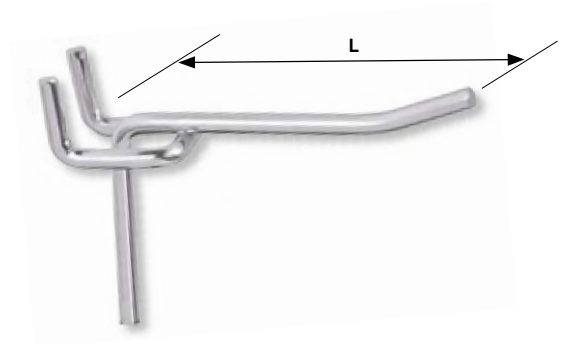

Halterung für Reinigungstuch-Rollen
Support de rouleau d'essuyage
Supporto portarotolo

Art.
3925

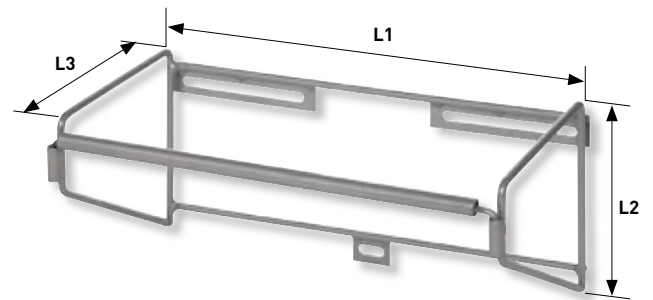

↕ L1 330 × L2 175 × L3 140 mm

Aussenkorb
mit Einlegewanne
Corbeille extérieure
avec bac
Cestino esterno
con salvagoccia

Art.
3923

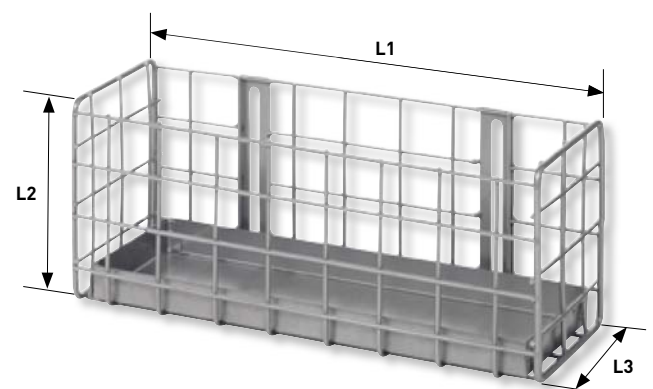

↕ L1 280 × L2 115 × L3 95 mm

Magnetischer Werkzeughalter
für Stecknüsse und Druckluftwerkzeuge

Support magnétique
pour douilles et outils pneumatiques

Supporto magnetico
per bussole ed utensili pneumatici

Art.

3929



↕ L 400 x 130 x 150 mm

LED-Unterbauleuchten

Die Leuchten sind mit Magneten und Montagebügeln ausgestattet und sind daher flexibel einsetzbar. Die beiden Größen können nach Wunsch einfach in Serie zusammengeschaltet werden.

Panneau lumineuse à LED

Les lampes sont équipées d'aimants et peuvent donc être déplacées selon les besoins. Les 2 tailles peuvent être facilement installées et branchées en série.

Lampada sottopensile a LED

Le lampade sono dotate di magneti e possono essere disposte dove si necessita, anche in serie.

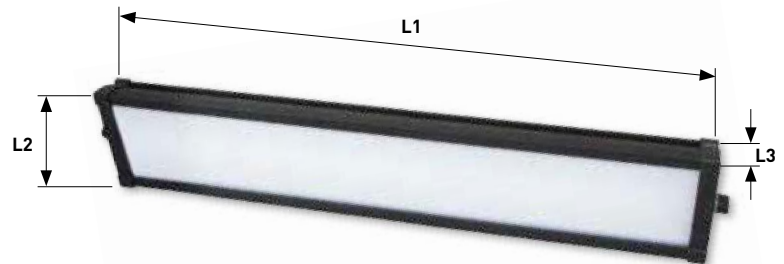
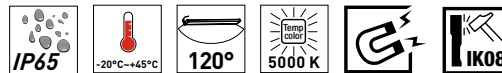

Art.	SMD-LED	LM	W	⚖️ kg
32077-60	120	1800	20	1.2
32077-120	240	3600	40	2.3



Inklusive Zubehör
Accessoires inclus
Accessori inclusi

	L1 / mm	L2 / mm	L3 / mm
32077-60	590	124	43
32077-120	1200	124	43

Werkbänke

mit höhenverstellbaren Stellfüßen, 3 cm dicke Multiplexplatte, spritzwasserfest, schmutzabweisend und weitgehend unempfindlich gegen Öl und Fett. Max. Belastbarkeit 150 kg

Établi

avec réglage de hauteur, plateau Multiplex 3 cm, résistant aux projections d'eau, anti-poussières et très résistant aux graisses et à l'huile.

Charge maximale : 150 kg

Banchi da lavoro

con regolatre di livello, piano di lavoro di 3 cm, resistente agli spruzzi d'acqua, resistente allo sporco e ampiamente immune e agli olii e al grasso.

Portata massima 150 kg

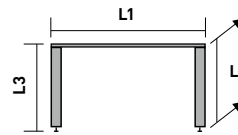

Art.
7526
7527

	L1 / mm	L2 / mm	L3 / mm	Δ kg
7526	1600	600	880 - 930	150
7527	1600	800	880 - 930	150

Werkbank

in robuster Stahlblechkonstruktion, mit 20 mm starker Buchen-Multiplex-Arbeitsplatte mit zusätzlichem Schutz durch Leinölfirnis. 3 kugelgelagerte Schubladen. KRAFTWERK-Werkzeugeinlagen (COMPLETO-Hartschalen, EVA, EVA3) haben bequem in der unteren, langen Schublade Platz. Eine Werkzeugwand und ein Oberschrank bieten viel Stauraum für Werkzeuge.

Établi

avec une structure robuste en acier, un plan de travail multiplex de 20 mm d'épaisseur en hêtre protégé par un vernis d'huile de lin. 3 tiroirs sur roulements à billes. Les inserts d'outils KRAFTWERK (COMPLETO-rigide, EVA, EVA3) trouvent leurs places dans le tiroir inférieur. La paroi perforée et les meubles à abattant haut offrent un bel espace de rangement pour les outils.

Banco la lavoro

con solida struttura in acciaio, piano di lavoro in multistrato da 20mm in faggio con protezione grazie alla verniciatura all'olio di lino. 3 Cassetti su cuscinetti a sfera. I moduli portautensili KRAFTWERK (COMPLETO, EVA, EVA3) trovano posto nel cassetto inferiore. Completo di parete forata ed armadietto a parete.



	L1 / mm	L2 / mm	L3 / mm	Δ kg
	1145	635	1585	80
L4	457	423	93	20
L5	921	483	93	30

Art.
3962

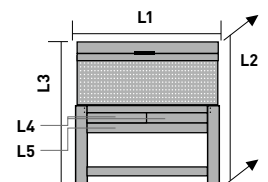

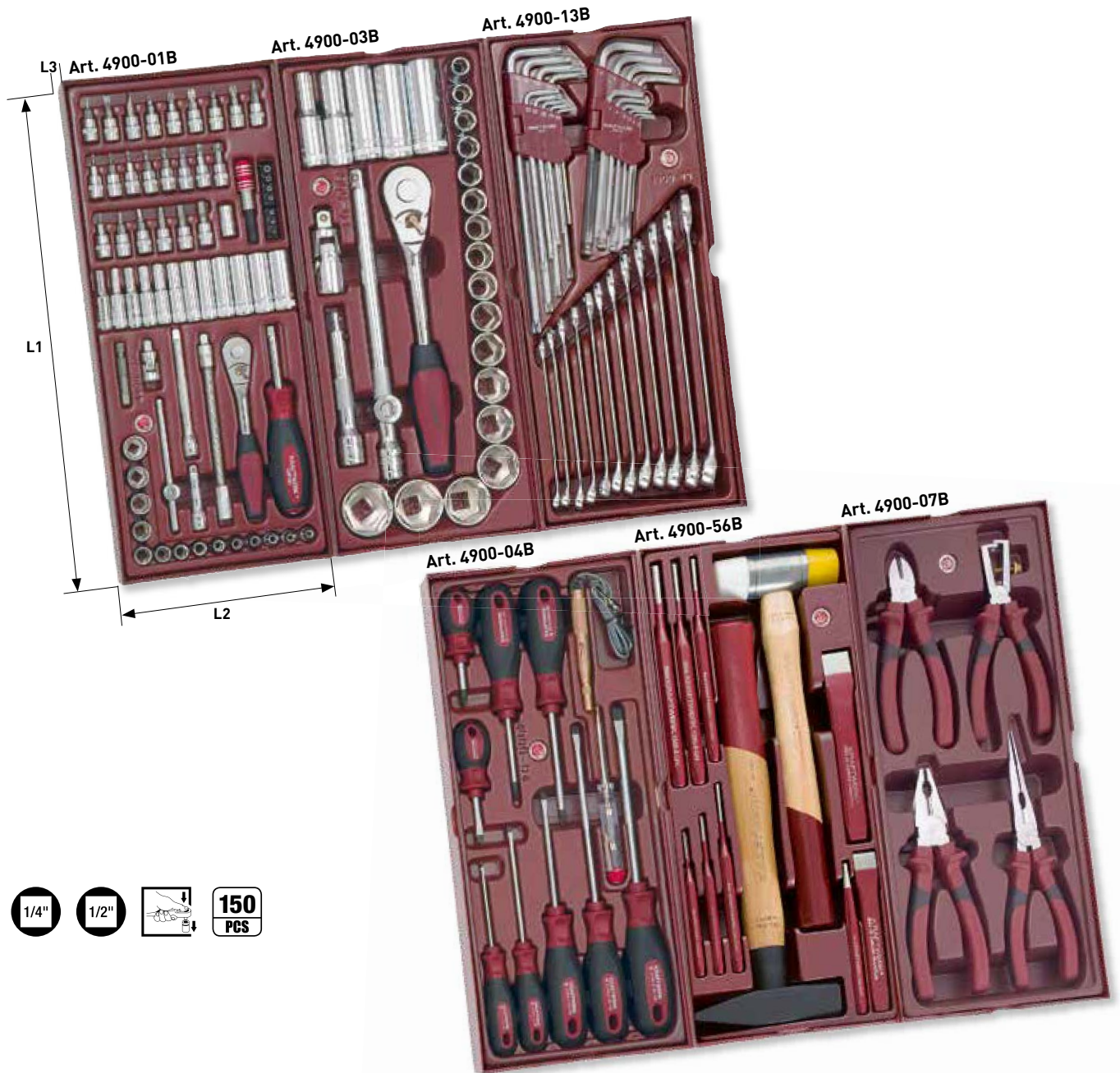

Werkzeug-Zusammenstellung

Basis-Sortiment für 2 Schubladen

Assortiment d'outils

de base pour 2 tiroirs

Assortimento di utensili

base per 2 cassetti

Art.	
4909	4900-01B, 4900-03B, 4900-13B, 4900-04B, 4900-56B, 4900-07B

↔ L1 402 × L2 173 × L3 48 mm

Werkzeug-Zusammenstellung

mit Werkstattwagen

Assortiment d'outils

avec servantes

Assortimento di utensili

con carrelli

	Art.
1	3907-4909
2	3908-4909
3	3905-4909
4	3934-4909
5	2905-4909
6	2907-4909
7	2904-4909



COMPLETO SERIE 4900



Werkzeug-Zusammenstellung

Basis-Sortiment für 3 Schubladen

Assortiment d'outils

de base pour 3 tiroirs

Assortimento di utensili

base per 3 cassetti

Art.	
4911	4900-01B, 4900-03B, 4900-04B, 4900-13B, 4900-14B, 4900-07B, 4900-56B, 4900-10B, 4900-11B

↔ L1 402 × L2 173 × L3 48 mm

Werkzeug-Zusammenstellung

mit Werkstattwagen

Assortiment d'outils

avec servantes

Assortimento di utensili

con carrelli

	Art.
1	3907-4911
2	3908-4911
3	3905-4911
4	3934-4911
5	2905-4911
6	2907-4911
7	2904-4911



Werkzeug-Zusammenstellung
mit 24 Einlagen

Assortiment d'outils

avec 24 coquilles

Assortimento di utensili

con 24 vaschette



Art. 4920



Art. 4920F

Art.	
4920	4900-01B, 4900-02B, 4900-03B, 4900-38B, 4900-20B, 4900-19B, 4900-16B, 4900-22B, 4900-15B, 4900-13B, 4900-14B, 4900-40B, 4900-04B, 4900-05B, 4900-59B, 4900-11B, 4900-12B, 4900-73B, 4900-33B, 4900-57B1, 4900-09B, 4900-66B, 4900-10B, 4900-21B,
4920F	4900-01B, 4900-02B, 4900-03B, 4900-38B, 4900-20B, 4900-19B, 4900-16B, 4900-22B, 4900-18B, 4900-13B, 4900-14B, 4900-40B, 4900-04B, 4900-05B, 4900-59B, 4900-11B, 4900-12B, 4900-73B, 4900-33B, 4900-57B1, 4900-09B, 4900-66B, 4900-10B, 4900-21B,

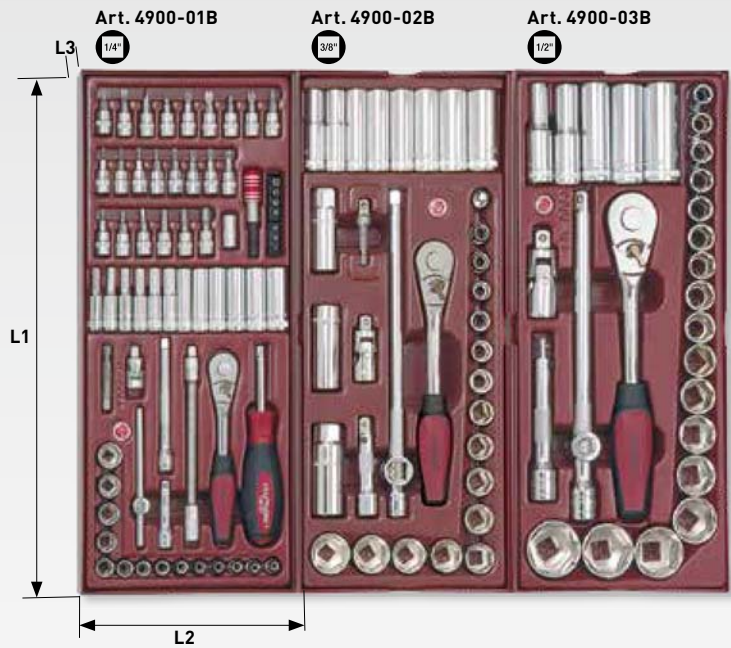

↕ L1 402 x L2 173 x L3 48 mm

Art. 4900-38B



Art. 4900-20B



Art. 4900-19B

Art. 4900-16B

Art. 4900-22B

Art. 4900-15B

(nur / seulement / solo 4920)



COMPLETO SERIE 4900

Art. 4900-13B



Art. 4900-14B



Art. 4900-40B



Art. 4900-04B



Art. 4900-05B



Art. 4900-59B



Art. 4900-11B



Art. 4900-12B



Art. 4900-73B



Art. 4900-33B



Art. 4900-57B1



Art. 4900-09B



HIGHTECH 3C

4GRIP

Art. 4900-66B



Art. 4900-10B



Art. 4900-21B



Art. 4900-18B
(nur / seulement / solo 4920F)



Werkzeug-Zusammenstellung
mit Werkstattwagen

Assortiment d'outils
avec servantes

Assortimento di utensili
con carrelli



561
PCS

Art. 4920

563
PCS

Art. 4920F



Art.		
3936-4920	12	
3936-4920F	12	

nur / seulement / solo
3936-4920



nur / seulement /
solo 3936-4920F

Art. 3936ES

9
PCS



Steckschlüssel-Schale
Coquille de douilles
Assortimento di chiavi a bussola in vaschetta



Art.
4900-03B

↔ L1 402 × L2 173 × L3 48 mm

- | | | |
|--|----|--|
| | 17 | 10-11-12-13-14-15-16-17-18
19-21-22-24-27-30-32-34 mm |
| | 5 | 10-13-17-19-22 mm |
| | | ○ 1/2" ■ 1/2" |
| | 2 | 125 mm / 250 mm |
| | | ○ 3/8" ■ 1/2" |

Art. 3220



inch
Steckschlüssel-Schale
Zollmasse
Coquille de douilles en pouce
Assortimento di chiavi a bussola in pollici in vaschetta



Art.
4900-29B

↔ L1 402 × L2 173 × L3 48 mm

- | | | | | | |
|--|---|--|--|---|---|
| | 9 | 3/16"-7/32"-1/4"-9/32"-5/16"
11/32"-3/8"-7/16"-1/2" | | 8 | 9/16"-5/8"-11/16"-3/4"
13/16"-7/8"-15/16"-1" |
| | 9 | 3/16"-7/32"-1/4"-9/32"-5/16"
11/32"-3/8"-7/16"-1/2" | | 3 | 9/16"-11/16"-3/4" |
| | | ○ 1/4" ■ 1/4" | | 2 | 5/8"-13/16" |
| | 2 | 50 mm / 100 mm | | | ○ 3/8" ■ 3/8" |
| | | ○ 3/8" ■ 1/4" | | 2 | 75 mm / 250 mm |
| | | | | | ○ 1/2" ■ 3/8" |

Art. 4009

Art. 4019

9 1/16"-5/64"-3/32"-1/8"-5/32"
3/16"-1/4"-5/16"-3/8"



Bit-Stecknuss-Schale
Coquille de douilles-embouts
Assortimento di bussole giravite lunghe e corte in vaschetta



Art.
4900-38B

↔ L1 402 × L2 173 × L3 48 mm

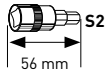

- 6 ⚙ T30-T40-T45-T50-T55-T60
- 6 ● 5-6-7-8-10-12 mm
- 6 ● M5-M6-M8-M10-M12-M14

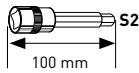

- 5 ⚙ T30-T40-T45-T50-T55
- 5 ● 6-7-8-10-12 mm
- 5 ● M5-M6-M8-M10-M12



Spezial-Bit-Stecknuss-Schale
Coquille de douilles-embouts spéciales
Assortimento di bussole ad inserto speciale in vaschetta



AUTOMOTIVE

Art.
4900-58B

↔ L1 402 × L2 173 × L3 48 mm

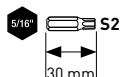

- 9 ⚙ T20-T25-T27-T30-T40-T45-T50-T55-T60
- 7 ● 4-5-6-7-8-10-12 mm
- 5 ● M5-M6-M8-M10-M12

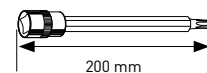

- 3 ⚙ T30-T40-T45

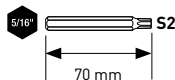

- 9 ⚙ T20-T25-T27-T30-T40-T45-T50-T55-T60
- 7 ● 4-5-6-7-8-10-12 mm
- 5 ● M5-M6-M8-M10-M12

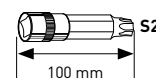

- ⚙ T70

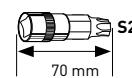

- ⚙ T80



- 3/8" ○ 5/16"
- 1/2" ○ 5/16"

38
PGS

Durchsteck-Steckschlüssel-Schale

Coquille de douilles débouchées

Assortimento chiavi a bussola in serie forate in vaschetta



Art.

4900-49B

↔ L1 402 × L2 173 × L3 48 mm

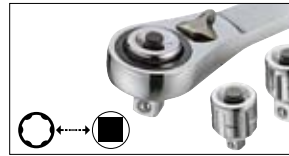

- 9 ○ 13 mm ○ 3.5-4-4.5-5-5.5-6-7-8-9 mm
- 10 ○ 20 mm ○ 10-11-12-13-14-15-16-17-18-19 mm
- 8 ○ 30 mm ○ 20-21-22-24-27-30-32-34 mm



13 mm × 1/4"

20 mm × 3/8"

30 mm × 1/2"



- 13 mm ○ 75 mm
- 20 mm ○ 75 mm
- 2 ○ 30 mm ○ 75 mm / 155 mm

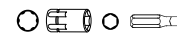

13 mm × 1/4"



13 mm Art. 590000

20 mm Art. 600000

30 mm Art. 610000

1/4" 3/8" 1/2" 5/16" **CrMo** **71**
PGS

Spezial-Steckschlüssel-/Bit-Schale

Coquille de douilles et embouts spéciaux

Assortimento di chiavi a bussola a macchina e inserti in vaschetta



Art.

4900-20B

↔ L1 402 × L2 173 × L3 48 mm



- 6 E4-E6-E7-E8-E10-E11
- 7 E10-E11-E12-E14-E16-E18-E20
- 5 E16-E18-E20-E22-E24
- 11 9-10-11-13-14-17-19-21-22-23-24 mm
- 5 17-19-21-22-24 mm

○ 3/8" ○ 5/16"

○ 1/2" ○ 5/16"



3 ○ 8-10-12 mm

2 + PH 3-4

2 + PZ 3-4

6 ★ T40-T45-T47-T50-T55-T60

12 ★ T10-T15-T20-T25-T27-T30 T40-T45-T50-T55-T60-T70

5 ● 6-8-10-12-14 mm

4 ● M6-M8-M10-M12



COMPLETO SERIE 4900

AUTOMOTIVE



Universal-Schlag-Steckschlüssel-Schale

Coquille universelle de douilles impact

Assortimento universale di chiavi a bussola a macchina



Art.	□
4900-70B	1/2"

↔ L1 402 × L2 173 × L3 48 mm

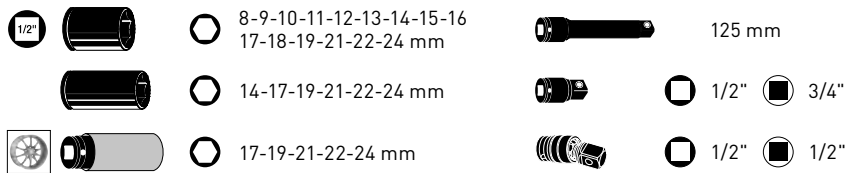

Schlagschrauber-Schale

Coquille de clé à choc pneumatique

Assortimento con avvitatore a percussione



AUTOMOTIVE

Art.	□	
4900-71B	1/2"	3833
4900-71B1	1/2"	3834

↔ L1 402 × L2 173 × L3 48 mm

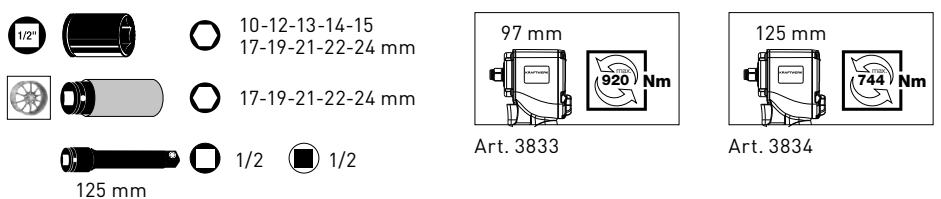

31
PGS

**Gabelring-/Innensechskant-/TX-
Winkel-Stiftschlüssel-Schale**

*Coquille de clés combinées et
de clés mâles hexagonales et TX*

**Assortimento di chiavi
combinata, maschi esagonali
e TX in vaschetta**



Art.

4900-13B

↔ L1 402 × L2 173 × L3 48 mm



DIN 3113

Art. 3508	8 mm	Art. 3514	14 mm
Art. 3509	9 mm	Art. 3515	15 mm
Art. 3510	10 mm	Art. 3516	16 mm
Art. 3511	11 mm	Art. 3517	17 mm
Art. 3512	12 mm	Art. 3518	18 mm
Art. 3513	13 mm	Art. 3519	19 mm

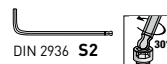

DIN 2936 S2



●● Art. 3602
1.5-2-2.5-3-4-5-6-7-8-10 mm

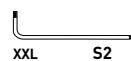

XXL

S2

★ Art. 3607
T10-T15-T20-T25-T27
T30-T40-T45-T50

8
PGS

Gabelringschlüssel-Schale

Coquille de clés combinées

**Assortimento di chiavi
combinata in vaschetta**



Art.

4900-14B

↔ L1 402 × L2 173 × L3 48 mm

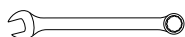

DIN 3113

Art. 3505	5.5 mm
Art. 3506	6 mm
Art. 3507	7 mm
Art. 3520	20 mm
Art. 3521	21 mm
Art. 3522	22 mm
Art. 3523	23 mm
Art. 3524	24 mm

COMPLETO SERIE 4900

15
PCS



inch

COMBINATION CLICKRAFT

**Gabelringschlüssel-Schale
Zollmasse**

*Coquille de clés
combinées en pouce*

**Assortimento di chiavi com-
binate in pollici in vaschetta**



Art.

4900-30B

↕ L1 402 × L2 173 × L3 48 mm

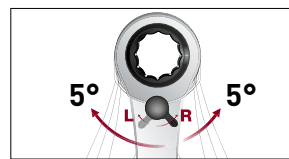
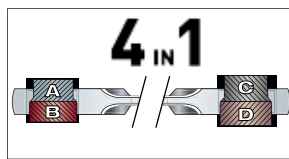

A 5/16"

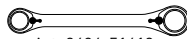

B 3/8"

Art. 3404-51612

C 7/16"

D 1/2"

Art. 3587 1/4"

Art. 3588 5/16"

Art. 3589 3/8"

Art. 3590 7/16"

Art. 3591 1/2"

Art. 3592 9/16"

Art. 3593 5/8"

Art. 3594 11/16"

Art. 3595 3/4"

Art. 3596 13/16"

Art. 3597 7/8"

Art. 3598 15/16"

Art. 3599 1"

A 9/16"

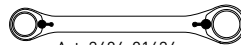

B 5/8"

Art. 3404-91634

C 11/16"

D 3/4"



19
PCS



**Ratschen-Ring-
gabelschlüssel-Schale**

*Coquille de clés
combinées à cliquet*

**Assortimento di chiavi com-
binate a cricchetto in vaschetta**

COMBINATION CLICKRAFT



Art.

4900-17B

↕ L1 402 × L2 173 × L3 48 mm

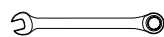

Art. 3405

5.5 mm

Art. 3406

6 mm

Art. 3407

7 mm

Art. 3408

8 mm

Art. 3409

9 mm

Art. 3410

10 mm

Art. 3411

11 mm

Art. 3412

12 mm

Art. 3413

13 mm

Art. 3414

14 mm

Art. 3415

15 mm

Art. 3416

16 mm

Art. 3417

17 mm

Art. 3418

18 mm

Art. 3419

19 mm

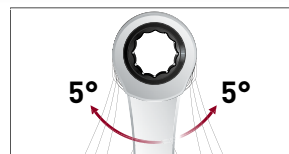

Art. 3691

● 1/4" ■ 10 mm

Art. 3692

● 3/8" ■ 13 mm

Art. 3693

● 1/2" ■ 19 mm



Art. 2694

● 1/4" ○ 10 mm



**Doppel-Ratschen-Ring-
gabelschlüssel-Schale**
*Coquille de clés
combinées à cliquet double*
Assortimento di chiavi
combinata a doppio
cricchetto in vaschetta

**COMBINATION +
DOUBLE RATCHET
CLICKRAFT**



Art.

4900-40B

↔ L1 402 × L2 173 × L3 48 mm

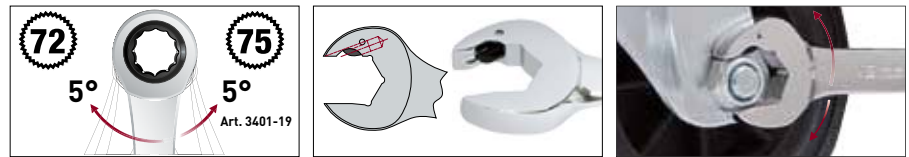

Art. 3405	5.5 mm	Art. 3401-08	8 mm
Art. 3406	6 mm	Art. 3401-09	9 mm
Art. 3407	7 mm	Art. 3401-10	10 mm
		Art. 3401-11	11 mm
		Art. 3401-12	12 mm
		Art. 3401-13	13 mm
		Art. 3401-14	14 mm
		Art. 3401-15	15 mm
		Art. 3401-16	16 mm
		Art. 3401-17	17 mm
		Art. 3401-18	18 mm
		Art. 3401-19	19 mm

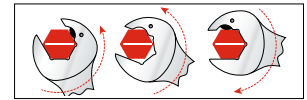

Option / Option / Opzionali

Art. 3691	1/4"	10 mm	
Art. 3692	3/8"	13 mm	
Art. 3693	1/2"	19 mm	
Art. 2694	1/4"	10 mm	



**90° Ratschen-Ringgabel-
schlüssel-Schale, extra lang**
*Coquille de clés combinées
à cliquet 90°, extra longues*
Assortimento di chiavi
combinata a cricchetto 90°,
extra lunghi in vaschetta

**LARGO 90
CLICKRAFT**



Art.

4900-28B

↔ L1 402 × L2 173 × L3 48 mm



Art. 4405-08	8 mm	Art. 4405-14	14 mm
Art. 4405-09	9 mm	Art. 4405-15	15 mm
Art. 4405-10	10 mm	Art. 4405-16	16 mm
Art. 4405-11	11 mm	Art. 4405-17	17 mm
Art. 4405-12	12 mm	Art. 4405-18	18 mm
Art. 4405-13	13 mm	Art. 4405-19	19 mm

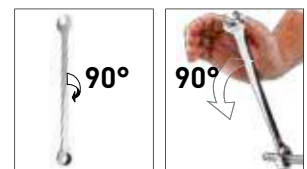

COMPLETO SERIE 4900

14
PCS



REVERSIBLE CLICKRAFT

Umschaltbare Ratschen-
Ringgabelschlüssel-Schale

*Coquille de clés combinées
à cliquet réversible*

Assortimento di chiavi
combinata a cricchetto
reversibili in vaschetta



Art.

4900-47B

↕ L1 402 × L2 173 × L3 48 mm

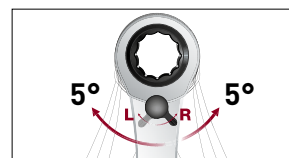

Art. 3404-08	8 mm	Art. 3404-15	15 mm
Art. 3404-09	9 mm	Art. 3404-16	16 mm
Art. 3404-10	10 mm	Art. 3404-17	17 mm
Art. 3404-11	11 mm	Art. 3404-18	18 mm
Art. 3404-12	12 mm	Art. 3404-19	19 mm
Art. 3404-13	13 mm	Art. 3404-22	22 mm
Art. 3404-14	14 mm	Art. 3404-24	24 mm

14
PCS



FLEX CLICKRAFT

Flexible Ratschen-Ring-
gabelschlüssel-Schale

*Coquille de clés combinées
à cliquet articulées*

Assortimento di chiavi a
cricchetto snodate in vaschetta



Art.

4900-46B

↕ L1 402 × L2 173 × L3 48 mm

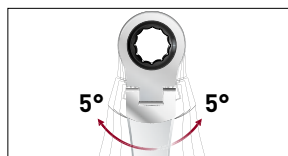

Art. 3403-08	8 mm	Art. 3403-15	15 mm
Art. 3403-09	9 mm	Art. 3403-16	16 mm
Art. 3403-10	10 mm	Art. 3403-17	17 mm
Art. 3403-11	11 mm	Art. 3403-18	18 mm
Art. 3403-12	12 mm	Art. 3403-19	19 mm
Art. 3403-13	13 mm	Art. 3403-22	22 mm
Art. 3403-14	14 mm	Art. 3403-24	24 mm

12
PGS 

Winkel-Ratschen-Ring-gabelschlüssel-Schale
Coquille de clés combinées à cliquet à angle
Assortimento di chiavi combinate a cricchetto orientabili in vaschetta

Art.

4900-41B

↔ L1 402 × L2 173 × L3 48 mm







**ANGLE
CLICKRAFT**



	
Art. 3402-08	8 mm
Art. 3402-09	9 mm
Art. 3402-10	10 mm
Art. 3402-11	11 mm
Art. 3402-12	12 mm
Art. 3402-13	13 mm

Art. 3402-14	14 mm
Art. 3402-15	15 mm
Art. 3402-16	16 mm
Art. 3402-17	17 mm
Art. 3402-18	18 mm
Art. 3402-19	19 mm

Option / Option / Opzionali

	Art. 3691	● 1/4" ■ 10 mm	
	Art. 3692	● 3/8" ■ 13 mm	
	Art. 3693	● 1/2" ■ 19 mm	
	Art. 2694	● 1/4" ○ 10 mm	

10
PGS

Doppelgabelschlüssel-Schale
Coquille de clés à fourches
Assortimento di chiavi fisse a forchetta in vaschetta

Art.

4900-16B

↔ L1 402 × L2 173 × L3 48 mm

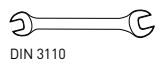

DIN 3110

Art. 3560	6 × 7 mm	Art. 3565	16 × 17 mm
Art. 3561	8 × 9 mm	Art. 3566	18 × 19 mm
Art. 3562	10 × 11 mm	Art. 3567	21 × 22 mm
Art. 3563	12 × 13 mm	Art. 3568	24 × 27 mm
Art. 3564	14 × 15 mm	Art. 3569	30 × 32 mm

11
PCS

Doppelringschlüssel-Schale
Coquille de clés polygonales
Assortimento di chiavi poligonali doppie in vaschetta

Art.

4900-15B

↔ L1 402 × L2 173 × L3 48 mm



DIN 838

Art. 3480	6 × 7 mm	Art. 3486	18 × 19 mm
Art. 3481	8 × 9 mm	Art. 3487	20 × 22 mm
Art. 3482	10 × 11 mm	Art. 3488	21 × 23 mm
Art. 3483	12 × 13 mm	Art. 3489	24 × 27 mm
Art. 3484	14 × 15 mm	Art. 3491	30 × 32 mm
Art. 3485	16 × 17 mm		

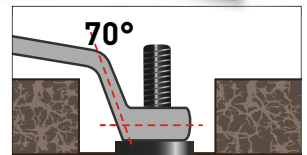

13
PCS



Offener Bremsschlüssel-/
Flexible Stubby-Ratschen-
Ringgabelschlüssel-Schale
Coquille de clés à tuyauter/
clés combinées à cliquet
articulées extra courtes
Assortimento di chiavi per
raccordi tubi e chiavi
combinati a cricchetto
snodate corte in vaschetta

Art.

4900-22B

↔ L1 402 × L2 173 × L3 48 mm



STUBBY FLEX
CLICKRAFT

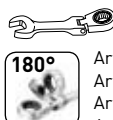
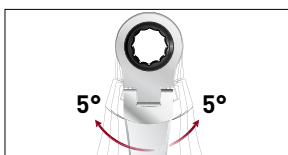

180°

Art. 3403-08S	8 mm
Art. 3403-10S	10 mm
Art. 3403-11S	11 mm
Art. 3403-12S	12 mm
Art. 3403-13S	13 mm
Art. 3403-14S	14 mm

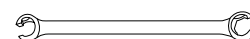

Art. 3580-00	9 × 11 mm
Art. 3580-01	10 × 12 mm
Art. 3580-02	13 × 14 mm
Art. 3580-03	15 × 17 mm
Art. 3580-04	3/8" × 7/16"
Art. 3580-05	1/2" × 9/16"
Art. 3580-06	5/8" × 11/16"

13
PGS

Pfeifenkopfschlüssel-Schale
Coquille de clés à pipe débouchées
Assortimento di chiavi a pipa in vaschetta



Art.	
4900-18B	
4900-48B	

↔ L1 402 × L2 173 × L3 48 mm

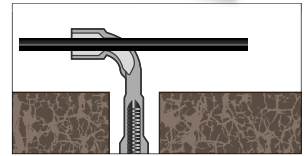
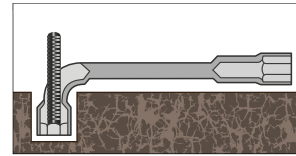

4900-18B

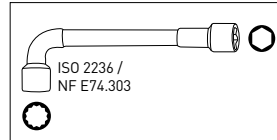

Art. 2598-08	8 mm
Art. 2598-09	9 mm
Art. 2598-10	10 mm
Art. 2598-11	11 mm
Art. 2598-12	12 mm
Art. 2598-13	13 mm
Art. 2598-14	14 mm

Art. 2598-15	15 mm
Art. 2598-16	16 mm
Art. 2598-17	17 mm
Art. 2598-18	18 mm
Art. 2598-19	19 mm
Art. 2598-22	22 mm

4900-48B

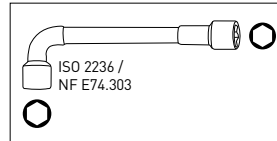

Art. 2597-08	8 mm
Art. 2597-09	9 mm
Art. 2597-10	10 mm
Art. 2597-11	11 mm
Art. 2597-12	12 mm
Art. 2597-13	13 mm
Art. 2597-14	14 mm

Art. 2597-15	15 mm
Art. 2597-16	16 mm
Art. 2597-17	17 mm
Art. 2597-18	18 mm
Art. 2597-19	19 mm
Art. 2597-22	22 mm

14
PGS

Rohrsteckschlüssel-Schale
Coquille de clés en tube droites
Assortimento di chiavi a tubo in vaschetta



Art.
4900-23B

↔ L1 402 × L2 173 × L3 48 mm

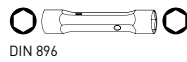

Art. 2599-06076	× 7 mm
Art. 2599-08098	× 9 mm
Art. 2599-101110	× 11 mm
Art. 2599-121312	× 13 mm
Art. 2599-141514	× 15 mm
Art. 2599-161716	× 17 mm

Art. 2599-1819	18 × 19 mm
Art. 2599-2022	20 × 22 mm
Art. 2599-2123	21 × 23 mm
Art. 2599-2427	24 × 27 mm
Art. 2599-2528	25 × 28 mm
Art. 2599-3032	30 × 32 mm

Art. 2599-1012	210 mm
Art. 2599-3457	165 mm

9
PCS

Doppelgelenkschlüssel-Schale
Coquille de clés
double-articulées
Assortimento di chiavi doppie
a bussola in vaschetta



Art.

4900-27B

↔ L1 402 × L2 173 × L3 48 mm

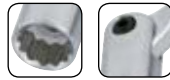

Art. 2590-0809	8 × 9 mm
Art. 2590-1011	10 × 11 mm
Art. 2590-1213	12 × 13 mm
Art. 2590-1415	14 × 15 mm
Art. 2590-1617	16 × 17 mm
Art. 2590-1819	18 × 19 mm

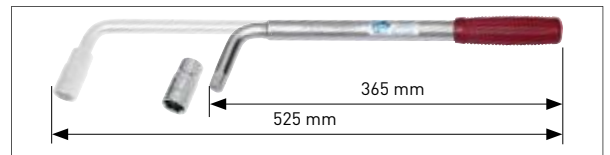

Art. 2590-3814 1/4" × 3/8"

Art. 2585-1719 1/2"

17 × 19 mm



Schraubendreher-Schale
PB Swissgrip
Coquille de tournevis
PB Swissgrip
Assortimento di giraviti
PB Swissgrip in vaschetta

Art.
4900-60B

↔ L1 402 × L2 173 × L3 48 mm



- Art. PB 8100 5 1.2 × 8 mm
- Art. PB 8100 4-140 1.0 × 6.5 mm
- Art. PB 8100 3-120 0.8 × 5.5 mm
- Art. PB 8100 2-100 0.6 × 4.0 mm
- Art. PB 8100 1- 90 0.5 × 3.5 mm
- Art. PB 8190 1- 80 PH1 × 80
- Art. PB 8190 2-100 PH2 × 100/6
- Art. PB 8451 10 × 30 mm
- Art. PB 1750 110-250 V



1/4" S2 T10-T15-T20-T25-T27-T30-T40



Schraubendreher-Schale
Coquille de tournevis
Assortimento di giraviti
in vaschetta

Art.
4900-04B

↔ L1 402 × L2 173 × L3 48 mm



ERGOKRAFT

- Art. 4110-1 0.6 × 3 mm
- Art. 4110-2 0.8 × 4 mm
- Art. 4110-3 1.0 × 5 mm
- Art. 4110-4 1.1 × 6 mm
- Art. 4110-5 1.2 × 8 mm
- Art. 4112-2 1.1 × 6 mm
- Art. 4117-2 PH 2
- Art. 2138 100-250 V
- Art. 2139 12 V
- Art. 4115-1 PH 1
- Art. 4115-2 PH 2

COMPLETO SERIE 4900

ERGOKRAFT

S2
quality

14
PCS



Schraubendreher-Schale
Coquille de tournevis
Assortimento di giraviti
in vaschetta

Art.

4900-05B

↔ L1 402 × L2 173 × L3 48 mm



	★ Art. 4125-08 T8		Art. 3177-20 0.45 × 2.0 mm
	Art. 4125-10 T10		Art. 3177-24 0.5 × 2.4 mm
	Art. 4125-15 T15		Art. 3177-30 0.6 × 3.0 mm
	Art. 4125-20 T20		Art. 3177-35 0.65 × 3.5 mm
	Art. 4125-25 T25		
	Art. 4125-27 T27		Art. 3177-0 PH 0
Art. 4125-30 T30	Art. 3177-1 PH 1		
Art. 4125-40 T40			

S2
quality

8
PCS

Schlagkappen-Schraubendreher-Schale
Coquille de tournevis de frappe
Assortimento di giraviti
martellabili in vaschetta



Art.

4900-54B

↔ L1 402 × L2 173 × L3 48 mm



ERGOKRAFT

	Art. 4140-3 5.5 × 100 mm		5.5 mm
	Art. 4140-4 6.5 × 125 mm		6.5 mm
	Art. 4140-5 8.0 × 150 mm		8.0 mm
	Art. 4140-6 10.0 × 175 mm		10.0 mm

	Art. 4145-1 PH1 × 75 mm	5.0 mm
	Art. 4145-2 PH2 × 100 mm	6.0 mm

	Art. 4150-1 PZ1 × 75 mm	5.0 mm
	Art. 4150-2 PZ2 × 100 mm	6.0 mm

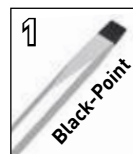
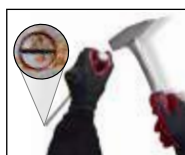



Steckschlüssel mit Griff-Schale
Coquille de clés à douille emmanchée
Assortimento di giraviti a bussola in vaschetta

Art.

4900-31B

↕ L1 402 × L2 173 × L3 48 mm



ERGOKRAFT

	Art. 4127-055	5.5 mm
	Art. 4127-06	6 mm
	Art. 4127-07	7 mm
	Art. 4127-08	8 mm
	Art. 4127-10	10 mm
	Art. 4127-11	11 mm
	Art. 4127-12	12 mm
	Art. 4127-13	13 mm



Kugelkopf-T-Griff-Schraubendreher-Schale
Coquille de tournevis mâles à tête sphérique en T
Assortimento di chiavi esagonali a T con testa a sfera in vaschetta

Art.

4900-25B

↕ L1 402 × L2 173 × L3 48 mm

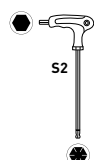

	Art. 3636-3	3 mm
	Art. 3636-4	4 mm
	Art. 3636-5	5 mm
	Art. 3636-6	6 mm
	Art. 3636-7	7 mm
	Art. 3636-8	8 mm
	Art. 3636-10	10 mm



ERGOKRAFT



TX-T-Griff-Schraubendreher-Schale

Coquille de tournevis TX en T

Assortimento di chiavi TX a T in vaschetta

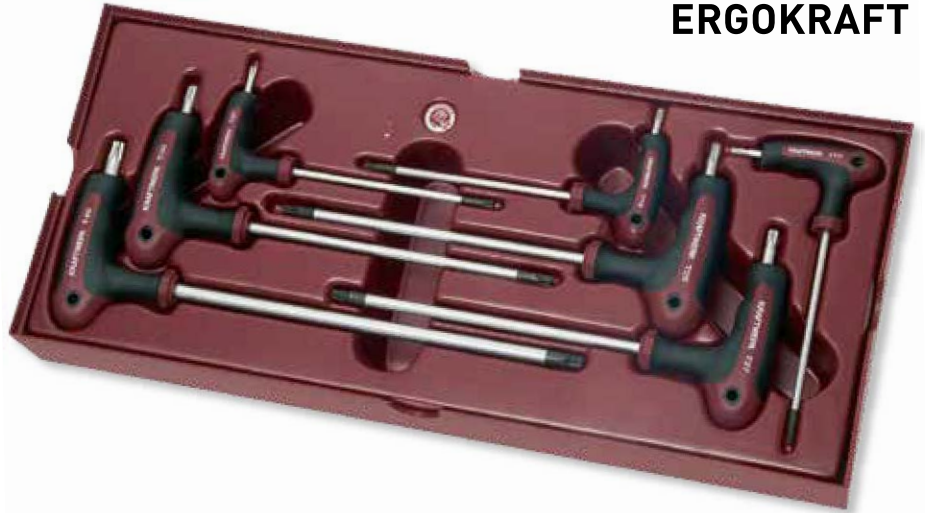

Art.

4900-26B

↔ L1 402 × L2 173 × L3 48 mm

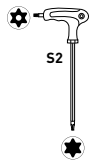

Art. 3637-10	T10
Art. 3637-15	T15
Art. 3637-20	T20
Art. 3637-25	T25
Art. 3637-27	T27
Art. 3637-30	T30
Art. 3637-40	T40



T-Griff-Stiftschlüssel-Schale Innensechskant

Coquille de clés mâles hexagonales en T

Assortimento di chiavi esagonali a T in vaschetta



Art.

4900-35B

↔ L1 402 × L2 173 × L3 48 mm

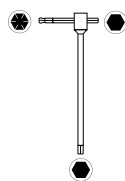

Art. 2593-02	2 mm
Art. 2593-025	2.5 mm
Art. 2593-03	3 mm
Art. 2593-04	4 mm
Art. 2593-05	5 mm
Art. 2593-06	6 mm
Art. 2593-07	7 mm
Art. 2593-08	8 mm
Art. 2593-10	10 mm

9
PCS

**TX-T-Griff-Stiftschlüssel-
Schale**

Coquille de clés TX en T

**Assortimento di chiavi TX a T
in vaschetta con impugnatura
scorrevole**



Art.

4900-36B

↔ L1 402 × L2 173 × L3 48 mm

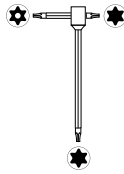

- | | |
|--------------|-----|
| Art. 2594-10 | T10 |
| Art. 2594-15 | T15 |
| Art. 2594-20 | T20 |
| Art. 2594-25 | T25 |
| Art. 2594-27 | T27 |
| Art. 2594-30 | T30 |
| Art. 2594-40 | T40 |
| Art. 2594-45 | T45 |
| Art. 2594-50 | T50 |

85
PCS

**Universal-Bit-Ratschen- und
Schraubwerkzeug-Schale**

*Coquille d'outils universels
avec cliquet et embouts*

**Assortimento universale
di inserti e giravite a
percussione in vaschetta**



Art.

4900-19B

↔ L1 402 × L2 173 × L3 48 mm

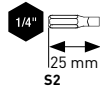

- 6 4-4.5-5.5-6-6.5-8 mm
- 4 PH 1-2-3-4
- 4 PZ 1-2-3-4
- 8 T8-T10-T15-T20
T-25-T27-T30-T40
- 8 T8-T10-T15-T20
T-25-T27-T30-T40
- 6 3-4-5-6-7-8 mm
- 6 2-2.5-3-4-5-6 mm
- 6 5/64"-3/32"-7/64"
1/8"-9/64"-5/32"

- 1/4" 1/4"
- 1/4" 1/4"
- 1/4" 1/4"
- Art. 3766 150 mm
- Art. 3767 300 mm
- 90 mm
- Art. 3634
- Art. 3798



- 4 6-8-10-12 mm
- 4 PH 1-2-3-4
- 4 T30-T40-T45-T50
- 3/8" 5/16"
- 5/16" 3/8"
- 90 mm
- 150 mm
- Art. 2035S



- 3 Nos. 6-8-10
- 4 Nos. 1-2-3-4
- 4 Nos. 4-6-8-10



Elektriker-Steckschlüssel- und Innensechskantschlüssel-Schale VDE

mit voll isolierter VDE-Umschaltknarre 1000V

Coquille de clés mâles et douilles d'électricien VDE

avec cliquet réversible VDE entièrement isolé 1000V

Assortimento di chiavi esagonali e chiavi a bussola VDE in vaschetta

con chiave a cricchetto reversibile completamente isolato 1000V

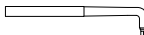
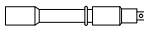
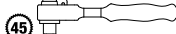

	8	8-10-12-13-14-17-19-22 mm	
	Art. 3136-025	2.5 x 126 mm	
	Art. 3136-03	3.0 x 126 mm	
	Art. 3136-04	4.0 x 160 mm	
	Art. 3136-05	5.0 x 160 mm	
	Art. 3136-06	6.0 x 200 mm	
	Art. 3136-08	8.0 x 200 mm	
	Art. 207150V	3/8" x 150 mm	
	Art. 3210V	200 mm	



Art.
4900-61B

↔ L1 402 x L2 173 x L3 48 mm



Elektriker-Steckschlüssel mit Griff-Schale VDE

Coquille de clés à douille emmanchée d'électricien VDE

Assortimento di giraviti a bussola VDE 1000V in vaschetta



Art.
4900-62B

↔ L1 402 x L2 173 x L3 48 mm

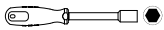
	Art. 3138-07	7.0 x 125 mm
	Art. 3138-08	8.0 x 125 mm
	Art. 3138-09	9.0 x 125 mm
	Art. 3138-10	10.0 x 125 mm
	Art. 3138-11	11.0 x 125 mm
	Art. 3138-12	12.0 x 125 mm
	Art. 3138-13	13.0 x 125 mm
	Art. 3138-14	14.0 x 125 mm



8
PGS

Elektriker-Schraubendreher-Schale VDE

Coquille de tournevis d'électricien VDE



Assortimento di giraviti VDE in vaschetta



Art.

4900-63B

↔ L1 402 × L2 173 × L3 48 mm

	Art. 3132-1	2.5 × 75 mm
	Art. 3132-4	4.0 × 100 mm
	Art. 3132-5	5.5 × 125 mm
	Art. 3132-6	6.5 × 150 mm
	Art. 3135-0	PH0 × 60 mm
	Art. 3135-1	PH1 × 80 mm
	Art. 3135-2	PH2 × 100 mm
	Art. 2138	100-250 V



10
PGS

Elektriker-TX Schraubendreher-Schale VDE

mit Bohrung an der Spitze für TX-Schrauben mit und ohne Sicherungsstift

Coquille de tournevis TX d'électricien VDE

avec pointe percée, pour vis TX normales et TX vis de sécurité

Assortimento di giraviti TX VDE in vaschetta

con perforazione sulla punta, per viti TX normali e viti TX con pin di sicurezza



Art.

4900-64B

↔ L1 402 × L2 173 × L3 48 mm

	Art. 3133-06	T6 × 100 mm
	Art. 3133-07	T7 × 100 mm
	Art. 3133-08	T8 × 100 mm
	Art. 3133-10	T10 × 100 mm
	Art. 3133-15	T15 × 100 mm
	Art. 3133-20	T20 × 100 mm
	Art. 3133-25	T25 × 125 mm
	Art. 3133-27	T27 × 125 mm
	Art. 3133-30	T30 × 150 mm
	Art. 3133-40	T40 × 175 mm



10
PCS

Elektriker-Innensechskant-Schraubendreher- und Winkelstiftschlüssel-Schale VDE

Coquille de clés mâles et tournevis à six pans creux d'électricien VDE

Assortimento di chiavi e giraviti maschio esagonali VDE in vaschetta

Art.

4900-65B

↔ L1 402 × L2 173 × L3 48 mm



1000 V
IEC 60900

	Art. 3134-025	2.5 × 100 mm
	Art. 3134-03	3.0 × 100 mm
	Art. 3134-04	4.0 × 125 mm
	Art. 3134-05	5.0 × 150 mm
	Art. 3134-06	6.0 × 175 mm
	Art. 3134-08	8.0 × 200 mm

	Art. 3136-03	3.0 × 126 mm
	Art. 3136-04	4.0 × 160 mm
	Art. 3136-05	5.0 × 160 mm
	Art. 3136-06	6.0 × 200 mm

6
PCS

Elektriker-Zangen- und Schneidwerkzeug-Schale VDE

Coquille de pinces et outils de coupe d'électricien VDE

Assortimento di pinze ed utensili da taglio VDE in vaschetta

Art.

4900-67B

↔ L1 402 × L2 173 × L3 48 mm



	Art. 3281-180V DIN ISO 5746	180 mm
	Art. 3282-160V DIN ISO 5749	160 mm
	Art. 3285-200V DIN ISO 5745	200 mm
	Art. 2251V	
	Art. 3321V	
	4pcs. Art. 3321-4V	



1000 V
IEC 60900

4
PGS

Elektriker-Zangen-Schale VDE

*Coquille de pinces
d'électricien VDE*

**Assortimento di pinze VDE
per elettricista in vaschetta**

Art.

4900-43B

↔ L1 402 × L2 173 × L3 48 mm



Art. 4211-180
DIN ISO 5746

180 mm **K C H**



Art. 4212-160
DIN ISO 5749

160 mm **K C H**



Art. 4215-205
DIN ISO 5745

200 mm **C H**



Art. 4219-160
DIN ISO 5232

160 mm

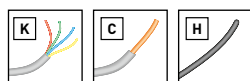

220 N/mm² 1800 N/mm²



1000 V
IEC 60900



HIGHTECH

4
PGS

Elektriker-Zangen-Schale VDE

*Coquille de pinces
d'électricien VDE*

**Assortimento di pinze VDE
per elettricista in vaschetta**

Art.

4900-42B

↔ L1 402 × L2 173 × L3 48 mm



Art. 3281-180V
DIN ISO 5746

180 mm



Art. 3282-160V
DIN ISO 5749

160 mm



Art. 3285-200V
DIN ISO 5745

205 mm



Art. 3289-160V
DIN ISO 5232

160 mm



1000 V
IEC 60900



4
PCS

Industrie-Zangen-Schale

mit 3-Komponenten-Griffen

Coquille de pinces industrielles

avec des manches 3-composants

Assortimento di pinze industriali in vaschetta

con manico in 3 componenti

Art.

4900-33B

↔ L1 402 × L2 173 × L3 48 mm



Art. 4271-180
DIN ISO 5746

180 mm **K C H**



Art. 4272-160
DIN ISO 5749

160 mm **K C H**



Art. 4275-205
DIN ISO 5745

205 mm **C H**



Art. 4279-160
DIN ISO 5232

160 mm



220 N/mm²

1800 N/mm²



3C-SoftGrip



ShockResistance



TitaniumFinish

4
PCS

Zangen-Schale

Coquille de pinces

Assortimento di pinze in vaschetta

Art.

4900-07B

↔ L1 402 × L2 173 × L3 48 mm



Art. 3281-180
DIN ISO 5746

180 mm



Art. 3282-160
DIN ISO 5749

160 mm



Art. 3285-200
DIN ISO 5745

200 mm



Art. 3289-160
DIN ISO 5232

160 mm

5
PCS

Universal-Zangen-Schale
Coquille de pinces universelles
Assortimento di pinze universali in vaschetta



Art.	
4900-57B1	4224-250
4900-57B2	4223-240
4900-57B3	4222-250

↔ L1 402 × L2 173 × L3 48 mm

HIGHTECH

4900-57B1 / Art. 4224-250





 Art. 4276-205 205 mm
DIN ISO 5745

HIGHTECH 3C

 Art. 3292-250 max. 250/10"

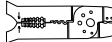
CrMo

 Art. 3290-230 230 mm
ERGOKRAFT  1.5 - 6 mm² 1.5 - 4.6 mm²

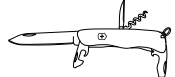
 **VICTORINOX**

4900-57B2 / Art. 4223-240





 Art. 4276-205 205 mm
DIN ISO 5745

HIGHTECH 3C

 Art. 3292-250 max. 250/10"

CrMo

 Art. 3290-230 230 mm
ERGOKRAFT  1.5 - 6 mm² 1.5 - 4.6 mm²

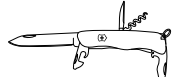
 **VICTORINOX**

4900-57B3 / Art. 4222-250

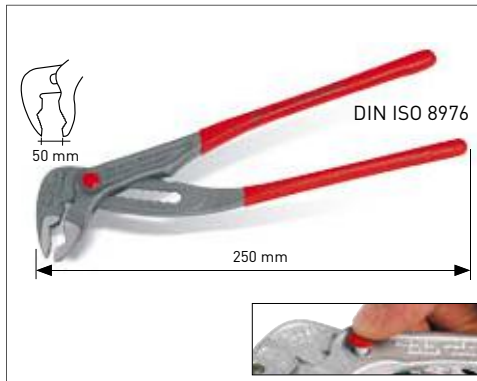



 Art. 4276-205 205 mm
DIN ISO 5745

HIGHTECH 3C

 Art. 3292-250 max. 250/10"

CrMo

 Art. 3290-230 230 mm
ERGOKRAFT  1.5 - 6 mm² 1.5 - 4.6 mm²

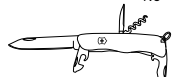
 **VICTORINOX**

4
PCS

Universal-Zangen-Schale
Coquille de pinces universelles
Assortimento di pinze universali in vaschetta



Art.
4900-08B

↔ L1 402 × L2 173 × L3 48 mm

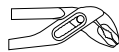

Art. 2221-250 250 mm
DIN ISO 8976



Art. 2216-200 200 mm
DIN ISO 9243



Art. 2262-07 7-1/2" 195 mm

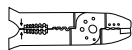

Art. 2225 240 mm 1.5 - 6 mm² 1.5 - 4.6 mm²

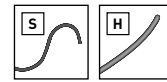

4
PCS

Seegerring-Zangen-Schale
Coquille de pinces pour circlips
Assortimento di pinze per anelli Seeger in vaschetta



Art.
4900-09B

↔ L1 402 × L2 173 × L3 48 mm

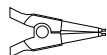

Art. 2212-A2
DIN ISO 5254A



Ø 19-60 mm

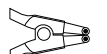

Art. 2213-A21
DIN ISO 5254B

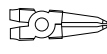

Art. 2214-J2
DIN ISO 5256C

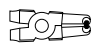

Art. 2215-J21
DIN ISO 5256D



5
PGS

Rollgabelschlüssel- und Zangen-Schale

Coquille de clés à molette et pinces

Assortimento di pinze autobloccanti, chiavi a rullino e cesoia in vaschetta



Art.

4900-21B

↔ L1 402 × L2 173 × L3 48 mm



ERGOKRAFT

Art. 3572	150 mm / 6"	○ 0-13 mm
Art. 3573	200 mm / 8"	○ 0-25 mm
DIN 3117 / ISO 6787		



ERGOKRAFT M2

Art. 2243	250 mm	HRC 58-60
-----------	--------	-----------



Art. 3292-175	175 mm / 7"	CrMo
---------------	-------------	------



Art. 3292-150	150 mm / 6"	CrMo
---------------	-------------	------

11
PGS

Feilen-Schale

Coquille de limes

Assortimento di lime in vaschetta



ERGOKRAFT

Art.

4900-10B

↔ L1 402 × L2 173 × L3 48 mm



Art. 4320-1	320 mm
DIN 7261	

▨ ○ ◻ ◀ ▽ Art. 4321



Art. 4320-2	320 mm
DIN 7261	



Art. 4320-3	320 mm
DIN 7261	



Art. 4320-4	320 mm
DIN 7261	



Art. 4320-5	320 mm
DIN 7261	

22
PCS

Schneidwerkzeug-Schale
Coquille d'outils de coupe
Assortimento di attrezzi da taglio in vaschetta



Art.
4900-11B

↔ L1 402 × L2 173 × L3 48 mm



ERGOKRAFT

Art. 3310 9 mm

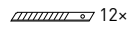

12x Art. 3313 9 mm



ERGOKRAFT

Art. 3312 18 mm



5x Art. 3314 18 mm



Art. 3305 300 mm



ERGOKRAFT

Art. 3308-1

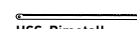

HSS-Bimetall

Art. 3316-24 300 mm



ERGOKRAFT

Art. 2240

11
PCS

Schlagwerkzeug-Schale
Coquille d'outils de frappe
Assortimento di attrezzi a percussione in vaschetta



Art.		
4900-56B	Art. 2305	500 g
4900-66B	Art. 2319	500 g

↔ L1 402 × L2 173 × L3 48 mm

4900-56B / Art. 2305



4900-66B / Art. 2319



HICKORY

Art. 2336 Ø 35 mm



Art. 3380-18
Art. 3380-22
DIN 6451/53

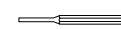

Art. 1350-2 2 mm
Art. 1350-3 3 mm
Art. 1350-4 4 mm
Art. 1350-5 5 mm
Art. 1350-6 6 mm
Art. 1350-8 8 mm
DIN 6450 Form C



Art. 1358-2 No. 2
DIN 7250

9
PCS









Messwerkzeug-Schale
Coquille d'outils de mesure
Assortimento di strumenti di misura in vaschetta

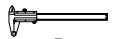

Art.

4900-12B

↕ L1 402 × L2 173 × L3 48 mm

	Art. 4701-0519	5 m × 19 mm	
	Art. 2970	150 mm × 0.05 mm	6" × 1/128"
	Art. 2975	0-25 mm × 0.01 mm	
	Art. 2976	300 mm × 28 mm	
	Art. 2977	200 mm	
	Art. 2978	100 mm × 70 mm	
	Art. 2974	0.05-0.1-0.15-0.2-0.3-0.4-0.5-0.6-0.7-0.8 mm	
	Art. 3196	130-630 mm / 2000 g	
	Art. 4996		

HSS-G **40**
PCS



Bohr- und Gewindeschneidwerkzeug-Schale
Coquille de tarauds et filières
Assortimento di maschi, filiere e punte in vaschetta



Art.

4900-34B

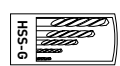
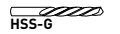
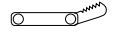
↕ L1 402 × L2 173 × L3 48 mm

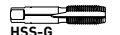
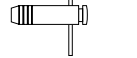
	Art. 23030	M3			Art. 11904	1-1.5-2-2.5-3-3.5-4
	Art. 23040	M4			DIN 338 N	4.5-5-5.5-6-6.5-7-7.5
	Art. 23050	M5				8-8.5-9-9.5-10 mm
	Art. 23060	M6				
	Art. 23080	M8				
	Art. 23100	M10			Art. 11033	3.3 mm
	Art. 23120	M12			Art. 11042	4.2 mm
					Art. 11068	6.8 mm
					Art. 11102	10.2 mm
	Art. 24200	0.25-6 mm / 60°			DIN 338 N	
	Art. 24015	M2-M12			Art. 25030	M3
	DIN 1814				Art. 25040	M4
					Art. 25050	M5
					Art. 25060	M6
					Art. 25080	M8
					Art. 25100	M10
	Art. 24110	M3-M10			Art. 25120	M12
	DIN 1814				DIN 371	

HSS-G **42**
PGS

**Bohr- und Gewinde-
schneidwerkzeug-Schale**
Coquille de tarauds et filières
**Assortimento di maschi,
filiere e punte in vaschetta**

Art.

4900-59B

↔ L1 402 × L2 173 × L3 48 mm



Art. 26030 M3
Art. 26040 M4
Art. 26050 M5
Art. 26060 M6
Art. 26080 M8
Art. 26100 M10
Art. 26120 M12
DIN / ISO 261



Art. 11904 DIN 338 N 1-1.5-2-2.5-3-3.5-4
4.5-5-5.5-6-6.6-7-7.5
8-8.5-9-9.5-10 mm

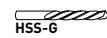

Art. 11033 3.3 mm
Art. 11042 4.2 mm
Art. 11068 6.8 mm
Art. 11102 10.2 mm
DIN 338 N

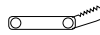

Art. 24200 0.25-6 mm / 60°

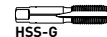

Art. 25030 M3
Art. 25040 M4
Art. 25050 M5
Art. 25060 M6
Art. 25080 M8
Art. 25100 M10
Art. 25120 M12
DIN 371



Art. 24010 M3-M12
DIN 225



Art. 24015 M2-M12
DIN 1814



Art. 24110 M3-M10
DIN 1814



Art. 3240S 0.5 mm

HSS-G **77**
PGS

**Gewinde-Einsatz-
Werkzeug-Schale**
*Kit de réparation de filetages,
avec filets rapportés*
**Assortimento di filetti
riportati in vaschetta**

Art.

4900-51B

↔ L1 402 × L2 173 × L3 48 mm



M4-M12, M6-M20
3/18"-1/2", 1/4"-3/4"



M5×0.8, M6×1.0,
M8×1.25, M10×1.5,
M12×1.75, M14×1.25

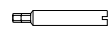

M5×0.8, M6×1.0,
M8×1.25, M10×1.5,
M12×1.75, M14×1.25



M5×0.8, M6×1.0,
M8×1.25, M10×1.5,
M12×1.75, M14×1.25



215-640 mm





0.5-1.75 mm

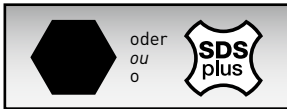

16 M5-0.8
12 M6-1.0
10 M8-1.25
6 M10-1.5
5 M12-1.75
4 M14-1.25



Lochsägen-Schale
Coquille de scies trépan
Assortimento di seghe a tazza in vaschetta





Art.		
4900-39B		✓
4900-39BS		

↔ L1 402 × L2 173 × L3 48 mm



16
PCS

15
PCS

	Art. 19001		Art. 19005	14-30 mm / 3/8"
	Art. 19002		Art. 19006	32-76 mm / 7/16"
	Art. 19003			300 mm / 3/8"
	Art. 19190	19 mm	Art. 19380	38 mm
	Art. 19200	20 mm	Art. 19440	44 mm
	Art. 19220	22 mm	Art. 19510	51 mm
	Art. 19250	25 mm	Art. 19570	57 mm
	Art. 19290	29 mm	Art. 19680	68 mm
	Art. 19320	32 mm	Art. 19760	76 mm
	Art. 19350	35 mm		

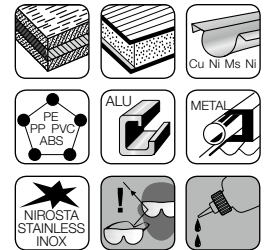

Modulare Werkstatt-LED-Lampen-Schale

- speziell starker 3 W COB-LED Lampenkopf
- extrem schmaler Lampenkopf mit 10 SMD-LED 3 W für schwer zugängliche Stellen
- Taschenlampen-LED-Kopf mit Zoom-Funktion
- Schwanenhals-LED-Lampenkopf
- 2 wiederaufladbare Auswechsel-Akkus
- Lampenhalter mit Vakuum-Saugfuss
- Ladestation mit Batterie-Ladeanzeige, USB-Ladekabel 100-240 V, Auto-/LKW-Lade-Adapter 12-24 V.

Coquille de lampes d'atelier à LED modulables

- Lampe à LED COB 3 W extrêmement puissante
- Lampe à tête extra fine avec 10 LED SMD de 3 watts pour les zones difficilement accessibles
- Lampe de poche à LED avec fonction zoom
- Lampe LED col de cygne
- 2 batteries rechargeables et interchangeables
- Support ventouse pour lampes
- Station de charge équipée d'un voyant de charge, avec câble USB, chargeur secteur 100-240V et prise allume-cigare 12-24V

Assortimento di lampade modulari LED per officina in vaschetta

- Lampada da 3 W COB-LED particolarmente potente
- Testa estremamente sottile a 10 SMD-LED 3 W per illuminare posti difficili da raggiungere
- Testa torcia LED con funzionalità zoom
- Lampada a LED a collo di cigno
- 2 batterie ricaricabili ed intercambiabili
- Base per lampada a ventosa
- Alimentatore con indicatore del livello della batteria, cavo USB 100-240 V ed adattatore per auto e camion da 12-24 V

11
PCS



Art. 4900-73B

421 x 200 x 68 mm

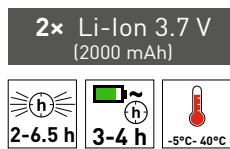

Art.

4900-73B

Reifendruck-Kontrollsystem-Werkzeugschale
geeignet für TPMS, zur Demontage und Montage von Reifendruck-Kontrollsystemen. Optimale Bestückung für alle Typen.

Coquille d'outils pour capteur de pression de pneu

adaptés pour TPMS, pour démonter et monter les systèmes de contrôle de pression des pneus. Composition optimale pour tous les modèles.

Assortimento di utensili per il controllo della pressione dei pneumatici

per TPMS, per lo smontaggio e rimontaggio del sistema della pressione dei pneumatici. Assortimento ottimale per tutti i veicoli.

1/4" 15 PCS

AUTOMOTIVE

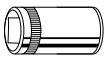

2 11-12 mm

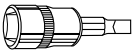

3 T10-T15-T20
4.5 mm



50 mm

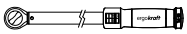

Art. 3231

2.5-12 Nm / 20-105 Lb.in

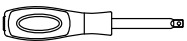

1/4" 1/4"



140 mm

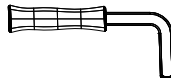

1/4" 100 mm



1/4"

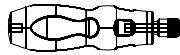

1/4" 4 mm 0 Lb.in 150 mm
0.5-3.5 Nm / 4.5-30 Lb.in 150 mm

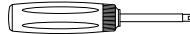

2 0.25-0.45 Nm / 2.2-4 Lb.in 120 mm



2 mm

421 x 200 x 68 mm

Art.

4900-74B

Klebegewichtezange-Schale

Coquille de pince pour masse d'équilibre adhésive

Vaschetta con pinza per contrappesi adesivi

5 PCS

AUTOMOTIVE



Art. 4257-240 240 mm



Art. 3843 225 mm



Art. 3843RE Ø 100 x 15 mm



DE



FR



IT



421 x 200 x 68 mm

Art.

4900-75B

COMPLETO SERIE 4900

Kleinteile-Schale

Coquilles pour petites pièces

Vaschetta portaminuteria

Art.

4900-37B

↕ L1 402 × L2 173 × L3 48 mm



ABS-Schale

leer

Coquille en ABS

vide

Scomparto in ABS

vuoto

Art.

4900E

↕ L1 402 × L2 173 × L3 48 mm



ABS-Tragkoffer

für COMPLETEO-Schalen, leer

Coffret en ABS

pour coquilles COMPLETEO, vide

Valigetta ABS

per assortimenti COMPLETEO, vuota

Art.

4900K

↕ L1 421 × L2 200 × L3 68 mm





COMPLETO EVA3 SERIE 4903

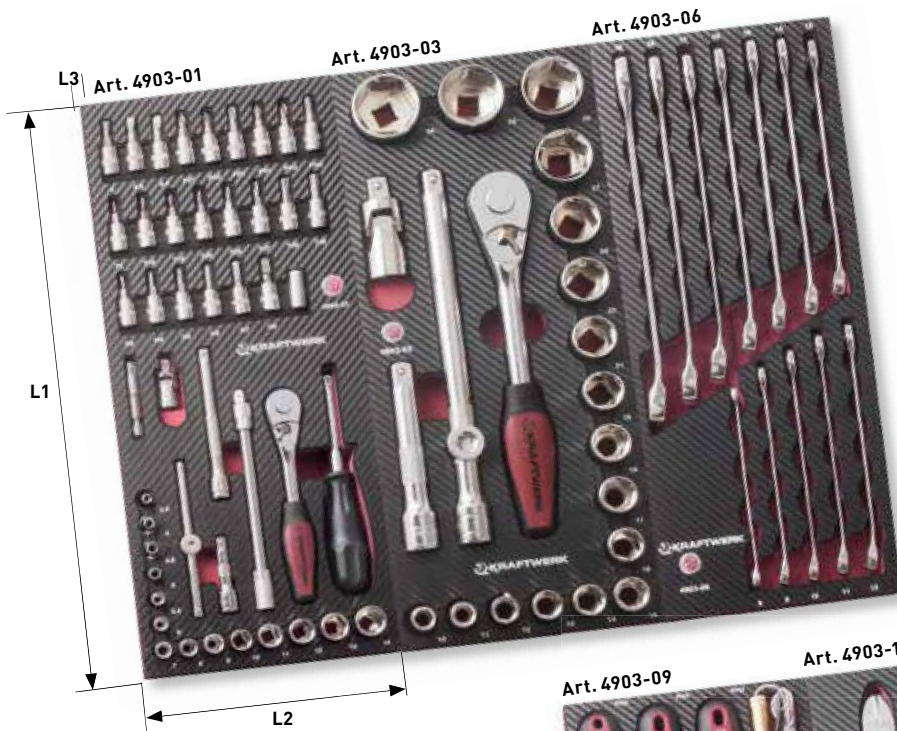

Werkzeug-Zusammenstellung

Basis-Sortiment für 2 Schubladen

Assortiment d'outils

de base pour 2 tiroirs

Assortimento di utensili

base per 2 cassette

Art.	
4931	4903-01, 4903-03, 4903-06, 4903-09, 4903-11, 4903-13

↕ L1 394 × L2 168 × L3 30 mm

Werkzeug-Zusammenstellung

mit Werkstattwagen

Assortiment d'outils

avec servantes

Assortimento di utensili

con carrelli

	Art.
1	3907-4931
2	3908-4931
3	3905-4931
4	3934-4931
5	2905-4931
6	2907-4931
7	2904-4931





Steckschlüssel-Einlage

Module de douilles

Assortimento di chiavi a bussola in vassoio

Art.
4903-01

↕ 394 x 168 x 30 mm



- | | | | | | |
|--|----|---|--|----|----------------|
| | 14 | 3.5-4-4.5-5-5.5-6-7-8-9-10-11-12-13-14 mm | | 2 | 50 mm / 100 mm |
| | 3 | 4-5.5-6.5 mm | | | 150 mm |
| | 3 | PH 1-2-3 | | | 115 mm |
| | 3 | PZ 1-2-3 | | | ○ 1/4" ■ 1/4" |
| | 8 | T8-T10-T15-T20-T25-T27-T30-T40 | | | ● 1/4" ■ 1/4" |
| | 6 | 3-4-5-6-7-8 mm | | | |
| | | ○ 1/4" ○ 1/4" | | | |
| | | ○ 1/4" ■ 1/4" | | | |
| | | | | 45 | Art. 3200 |



Steckschlüssel-Einlage

Module de douilles

Assortimento di chiavi a bussola in vassoio

Art.
4903-02

↕ 394 x 168 x 30 mm



- | | | |
|--|----|---|
| | 15 | 8-9-10-11-12-13-14-15-16-17-18-19-21-22-24 mm |
| | 8 | 10-11-12-13-14-15-17-19 mm |
| | 2 | 16 mm / 21 mm |
| | | ○ 3/8" ■ 3/8" |
| | 2 | 75 mm / 250 mm |
| | | ○ 1/2" ■ 3/8" |
| | | ○ 3/8" ■ 1/4" |
| | | ● 1/4" ■ 3/8" |

45 Art. 3210

COMPLETO EVA3 SERIE 4903













Steckschlüssel-Einlage
Module de douilles
Assortimento di chiavi a bussola
in vassoio

Art.
4903-03

↕ 394 x 168 x 30 mm

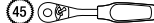

-  17 10-11-12-13-14-15-16-17-18
19-21-22-24-27-30-32-34 mm
-   1/2"  1/2"
-  2 125 mm / 250 mm
-   3/8"  1/2"
-  (45)  Art. 3220











Bit-Stecknuss-Einlage
Module de douilles-embouts
Assortimento di bussole giravite
in vassoio

Art.
4903-04

↕ 394 x 168 x 30 mm



-  S2 5  5-6-7-8-10 mm
-  55 mm 5  M5-M6-M8-M10-M12
-  S2 5  6-7-8-10-12 mm
-  100 mm 4  M5-M6-M8-M10



Steckschlüssel- und Bit-Stecknuss-Einlage







Module de douilles et douilles-embouts

Assortimento di bussole e bussole giravite in vassoio

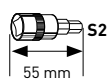

Art.
4903-05

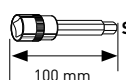
↕ 394 x 168 x 30 mm

-  8  E10-E12-E14-E16-E18-E20-E22-E24
-  S2 6  T30-T40-T45-T50-T55-T60
-  S2 5  T30-T40-T45-T50-T55



Gabelringschlüssel-Einlage

Module de clés combinées

Assortimento di chiavi combinate in vassoio



Art.
4903-06

↕ 394 x 168 x 30 mm

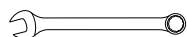
- 
- DIN 3113
- Art. 3508 8 mm
- Art. 3509 9 mm
- Art. 3510 10 mm
- Art. 3511 11 mm
- Art. 3512 12 mm
- Art. 3513 13 mm
- Art. 3514 14 mm
- Art. 3515 15 mm
- Art. 3516 16 mm
- Art. 3517 17 mm
- Art. 3518 18 mm
- Art. 3519 19 mm

8
PCS

Gabelringschlüssel-Einlage
Module de clés combinées
Assortimento di chiavi combinate
in vassoio

Art.
4903-07

↕ 394 x 168 x 30 mm

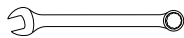

DIN 3113	
Art. 3505	5.5 mm
Art. 3506	6 mm
Art. 3507	7 mm
Art. 3520	20 mm
Art. 3521	21 mm
Art. 3522	22 mm
Art. 3523	23 mm
Art. 3524	24 mm

8
PCS

Doppelringschlüssel-Einlage
Module de clés polygonales
Assortimento di chiavi
poligonali doppie in vassoio

Art.
4903-08

↕ 394 x 168 x 30 mm



DIN 838		
Art. 3480	6 x 7 mm	Art. 3484 14 x 15 mm
Art. 3481	8 x 9 mm	Art. 3485 16 x 17 mm
Art. 3482	10 x 11 mm	Art. 3486 18 x 19 mm
Art. 3483	12 x 13 mm	Art. 3487 20 x 22 mm

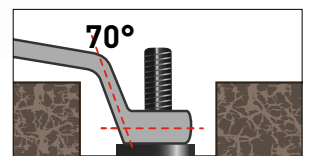



Gabelringschlüssel-Einlage
Module de clés combinées
Assortimento di chiavi combinate in vassoio

Art.
4903-16

↕ 394 x 168 x 30 mm



**COMBINATION
CLICKRAFT**



DIN 3113	
Art. 3408	8 mm
Art. 3409	9 mm
Art. 3410	10 mm
Art. 3411	11 mm
Art. 3412	12 mm
Art. 3413	13 mm
Art. 3414	14 mm
Art. 3415	15 mm
Art. 3416	16 mm
Art. 3417	17 mm
Art. 3418	18 mm
Art. 3419	19 mm

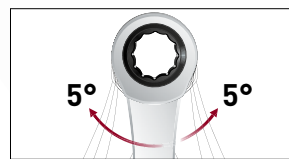

**Doppel-Ratschen-Ringgabel-
schlüssel-Einlage**
*Module de clés combinées à
cliquet double*
**Assortimento di chiavi combinate
a doppio cricchetto**

Art.
4903-17

↕ 394 x 168 x 30 mm



**COMBINATION +
DOUBLE RATCHET
CLICKRAFT**

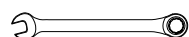

DIN 3113	
Art. 3401-08	8 mm
Art. 3401-09	9 mm
Art. 3401-10	10 mm
Art. 3401-11	11 mm
Art. 3401-12	12 mm
Art. 3401-13	13 mm
Art. 3401-14	14 mm
Art. 3401-15	15 mm
Art. 3401-16	16 mm
Art. 3401-17	17 mm
Art. 3401-18	18 mm
Art. 3401-19	19 mm

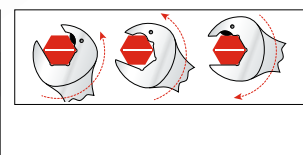
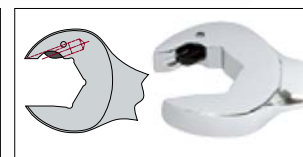
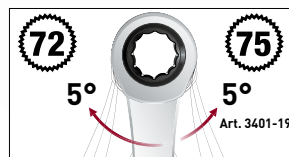

COMPLETO EVA3 SERIE 4903

REVERSIBLE CLICKRAFT

12
PCS



Umschaltbare Ratschen-Ring-
gabelschlüssel-Einlage

Module de clés combinées à
cliquet réversible

Assortimento di chiavi combinate
a cricchetto reversibili



Art.

4903-18

↕ 394 x 168 x 30 mm

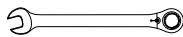

DIN 3113

Art. 3404-08	8 mm
Art. 3404-09	9 mm
Art. 3404-10	10 mm
Art. 3404-11	11 mm
Art. 3404-12	12 mm
Art. 3404-13	13 mm
Art. 3404-14	14 mm
Art. 3404-15	15 mm
Art. 3404-16	16 mm
Art. 3404-17	17 mm
Art. 3404-18	18 mm
Art. 3404-19	19 mm

CAP STOP

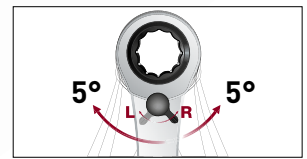
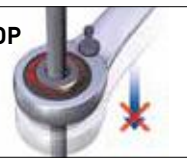

13
PCS

Pfeifenkopfschlüssel-Schalen

Coquille de clés à pipe
débouchées

Assortimenti di chiavi a pipa in
vaschetta



Art.

4903-29

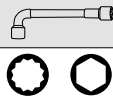

↕ 394 x 168 x 30 mm

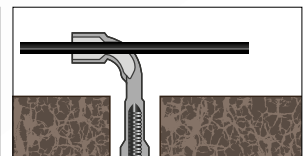
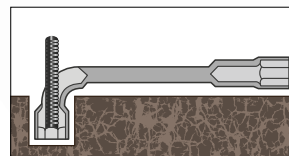



Art. 2597-07	7 mm
Art. 2597-08	8 mm
Art. 2597-09	9 mm
Art. 2597-10	10 mm
Art. 2597-11	11 mm
Art. 2597-12	12 mm
Art. 2597-13	13 mm

Art. 2597-14	14 mm
Art. 2597-15	15 mm
Art. 2597-16	16 mm
Art. 2597-17	17 mm
Art. 2597-18	18 mm
Art. 2597-19	19 mm

4
PGS

Pfeifenkopfschlüssel-Schalen
Coquille de clés à pipe débouchées
Assortimenti di chiavi a pipa in vaschetta

Art.	
4903-30	

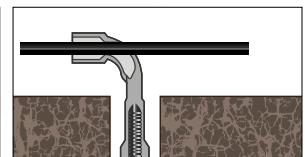
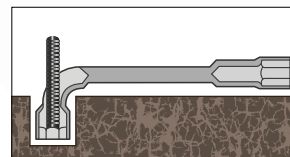

↕ 394 x 168 x 30 mm



- Art. 2597-20 20 mm
- Art. 2597-21 21 mm
- Art. 2597-22 22 mm
- Art. 2597-24 24 mm

3
PGS

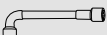
Pfeifenkopfschlüssel-Schalen
Coquille de clés à pipe débouchées
Assortimenti di chiavi a pipa in vaschetta

Art.	
4903-31	

↕ 394 x 168 x 30 mm

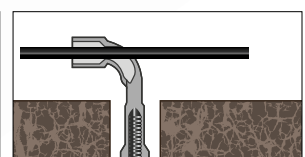
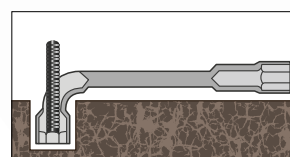

- Art. 2597-27 27 mm
- Art. 2597-30 30 mm
- Art. 2597-32 32 mm

COMPLETO EVA3 SERIE 4903

ERGOKRAFT









Schraubendreher-Einlage
Module de tournevis
 Assortimento di giraviti in
 vassoio

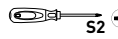

Art.
4903-09

↕ 394 x 168 x 30 mm

- | | | | |
|--|--|--|--|
|  S2 | Art. 4110-2 0.8 x 4 mm |  S2 | Art. 4112-2 1.1 x 6 mm |
| | Art. 4110-3 1.0 x 5 mm |  S2 |  + Art. 4117-2 PH 2 |
| | Art. 4110-4 1.1 x 6 mm | | |
| | Art. 4110-5 1.2 x 8 mm | | |
|  S2 |  + Art. 4115-1 PH 1 |  | Art. 2139 12 V |
| | Art. 4115-2 PH 2 | | |





Schraubendreher-Einlage
Module de tournevis
 Assortimento di giraviti in
 vassoio

ERGOKRAFT



Art.
4903-10

↕ 394 x 168 x 30 mm

- | | |
|--|---|
|  S2 |  Art. 4125-08 T8 |
| | Art. 4125-10 T10 |
| | Art. 4125-15 T15 |
| | Art. 4125-20 T20 |
| | Art. 4125-25 T25 |
| | Art. 4125-27 T27 |
| | Art. 4125-30 T30 |
| | Art. 4125-40 T40 |

S2 quality **8** PCS

Schlagkappen-Schraubendreher-Einlage
Module de tournevis de frappe
Assortimento di giraviti martellabili



Art.
4903-19

↔ 394 x 168 x 30 mm



	Art. 4140-3	5.5 x 100 mm	5.5 mm
	Art. 4140-4	6.5 x 125 mm	6.5 mm
	Art. 4140-5	8.0 x 150 mm	8.0 mm
	Art. 4140-6	10.0 x 175 mm	10.0 mm

	Art. 4145-1	PH1 x 75 mm	5.0 mm
	Art. 4145-2	PH2 x 100 mm	6.0 mm

	Art. 4150-1	PZ1 x 75 mm	5.0 mm
	Art. 4150-2	PZ2 x 100 mm	6.0 mm



1/4" **1/4"** **16** PCS

Schraubendreher-Einlage PB Swissgrip
Module de tournevis PB Swissgrip
Assortimento di giraviti PB Swissgrip



Art.
4903-20

↔ 394 x 168 x 30 mm

	Art. PB 8100 5	1.2 x 8 mm
	Art. PB 8100 4-140	1.0 x 6.5 mm
	Art. PB 8100 3-120	0.8 x 5.5 mm
	Art. PB 8100 2-100	0.6 x 4.0 mm
	Art. PB 8100 1- 90	0.5 x 3.5 mm

	Art. PB 8190 1- 80	PH1 x 80
	Art. PB 8190 2-100	PH2 x 100/6

	Art. PB 8451	10 x 30 mm
--	--------------	------------

	Art. PB 1750	110-250 V
--	--------------	-----------



1/4" **S2** T10-T15-T20-T25-T27-T30-T40

COMPLETO EVA3 SERIE 4903

S2
quality

29
PCS

Winkelstiftschlüssel-Einlage
Module de clés coudées
Assortimento di chiavi maschi esagonali



Art.

4903-27

↕ 394 x 168 x 30 mm



DIN 2936 S2



Art. 3604

1.5-2-2.5-3-4-5-6-7-8-10 mm

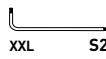

XXL S2



Art. 3608

T10-T15-T20-T25-T27
T30-T40-T45-T50

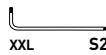

XXL S2

Art. 3609

T10-T15-T20-T25-T27
T30-T40-T45-T50



ERGOKRAFT

Art. 3574 250 mm / 10" ○ 0-30 mm
DIN 3117 / ISO 6787

S2
quality

7
PCS

Kugelkopf-T-Griff-Schraubendreher-Einlage
Module de tournevis mâles à tête sphérique en T
Assortimento di chiavi esagonali a T con testa a sfera



ERGOKRAFT

Art.

4903-21

↕ 394 x 168 x 30 mm

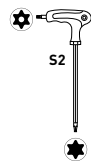

S2

Art. 3636-3

T3

Art. 3636-4

T4

Art. 3636-5

T5

Art. 3636-6

T6

Art. 3636-7

T7

Art. 3636-8

T8

Art. 3636-10

T10

S2
quality

7
PCS

**TX-T-Griff-Schraubendreher-
Einlage**

Module de tournevis TX en T

Assortimento di chiavi TX a T



ERGOKRAFT

Art.

4903-22

↔ 394 x 168 x 30 mm

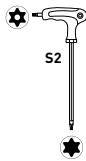

Art. 3637-10	T10
Art. 3637-15	T15
Art. 3637-20	T20
Art. 3637-25	T25
Art. 3637-27	T27
Art. 3637-30	T30
Art. 3637-40	T40

4
PCS

Hightech-Zangen-Satz

Module de pinces hightech

Assortimento di pinze hightech



HIGHTECH 3C

Art.

4903-15

↔ 394 x 168 x 30 mm



Art. 4271-180
DIN ISO 5746

180 mm **K C H**



Art. 4272-160
DIN ISO 5749

160 mm **K C H**



Art. 4275-205
DIN ISO 5745

205 mm **C H**



Art. 4223-240
DIN ISO 8976

240 mm



220 N/mm² 1800 N/mm²

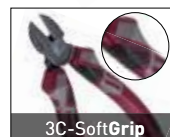

4
PCS

Zangen-Einlage
Module de pinces
Assortimento di pinze in
vassoio



Art.

4903-11

↕ 394 x 168 x 30 mm



Art. 3281-180 180 mm
DIN ISO 5746



Art. 3282-160 160 mm
DIN ISO 5749



Art. 3285-200 200 mm
DIN ISO 5745



Art. 3290-250 250 mm
DIN ISO 8976

4
PCS

Gripzangen-/Blechschere-
Einlage
Module de pinces-étaux
Assortimento di pinze a
morsetto/cesoia



Art.

4903-25

↕ 394 x 168 x 30 mm



Art. 2243 250 mm HRC 58-60



Art. 3292-175 175 mm / 7" CrMo



Art. 3292-250 250 mm / 10" CrMo



Art. 3292-150 150 mm / 6" CrMo

4
PGS

**Gripzangen-/Blehschere-
Einlage**

Module de pinces-étaux

Assortimento di pinze a
morsetto/cesoia



Art.

4903-26

↕ 394 x 168 x 30 mm



Art. 2243 250 mm HRC 58-60



Art. 3292-175 175 mm / 7" CrMo



Art. 3292-251 250 mm / 10" CrMo



Art. 3292-150 150 mm / 6" CrMo

4
PGS

Zangen-/Schere-Einlage

Module de pinces/cisaille

Assortimento di pinze/forbice



Art.

4903-28

↕ 394 x 168 x 30 mm



Art. 3289-160C 160 mm
DIN ISO 5232



Art. 2216-200C 200 mm
DIN ISO 9343



Art. 3290-230C



Art. 2240C 150 mm

4
PCS

Seegerring-Zangen-Einlage
Module de pinces pour circlips
Assortimento di pinze per anelli Seeger in vassoio



Art.

4903-12

↕ 394 x 168 x 30 mm

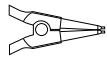

Art. 2212-A2
DIN ISO 5254A



Ø 19-60 mm



Art. 2213-A21
DIN ISO 5254B



Art. 2214-J2
DIN ISO 5256C



Art. 2215-J21
DIN ISO 5256D



18
PCS

Schneidwerkzeug-Einlage
Module d'outils de coupe
Assortimento di attrezzi da taglio



Art.

4903-23

↕ 394 x 168 x 30 mm



ERGOKRAFT

Art. 3310 9 mm

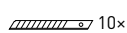

10x Art. 3313 9 mm



ERGOKRAFT

Art. 3312 18 mm

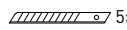

5x Art. 3314 18 mm



Art. 3305 300 mm

11
PGS

Feilen-Einlage
Module de limes
Assortimento di lime





ERGOKRAFT



Art.

4903-24

↕ 394 x 168 x 30 mm

-  Art. 4320-1 320 mm
DIN 7261
-  Art. 4320-2 320 mm
DIN 7261
-  Art. 4320-3 320 mm
DIN 7261
-  Art. 4320-4 320 mm
DIN 7261
-  Art. 4320-5 320 mm
DIN 7261

▯▯▯▯▯ Art. 4321

11
PGS

Schlagwerkzeug-Einlage
Module d'outils de frappe
Assortimento di attrezzi
a percussione in vassoio



Art.

4903-13

↕ 394 x 168 x 30 mm

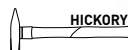
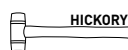
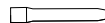
-  **HICKORY** Art. 2305 500 g
DIN 1041
-  **HICKORY** Art. 2336 ∅ 35 mm
-  Art. 3380-18 18 mm
Art. 3380-22 22 mm
DIN 6451/53

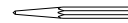
-  Art. 1350-2 2 mm x 115 mm
Art. 1350-3 3 mm x 125 mm
Art. 1350-4 4 mm x 150 mm
Art. 1350-5 5 mm x 165 mm
Art. 1350-6 6 mm x 180 mm
Art. 1350-8 8 mm x 180 mm
DIN 6450 Form C
-  Art. 1358-2 No. 2 x 120 mm
DIN 7250

COMPLETO EVA3 SERIE 4903

AUTOMOTIVE



Schlagschrauber-Einlage
Module de clé à choc
pneumatique
Assortimento con avvitatore
a percussione



Art.	1/2"	
4903-33	1/2"	3833
4903-34	1/2"	3834

↕ 394 x 168 x 30 mm

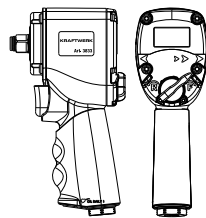

Art. 3833

1/2"	1149	920	678	9500	1500	<9.0	100.2
1.65	97	1/4"	3/8"	133	BSP	6.2	

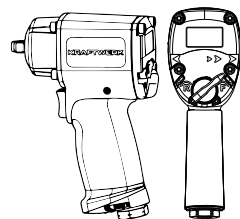

Art. 3834

1/2"	744	140-680	9000	1200	<3.6	90
1.6	125	1/4"	10	164	BSP	6.2-7



Art. 381170-0	17 mm
Art. 381190-0	19 mm
Art. 381210-0	21 mm
Art. 381220-0	22 mm
Art. 381240-0	24 mm



Art. 387125	125 mm
-------------	--------

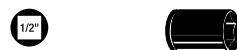

Art. 382100	10 mm
Art. 382120	12 mm
Art. 382130	13 mm
Art. 382140	14 mm
Art. 382150	15 mm
Art. 382170	17 mm
Art. 382190	19 mm
Art. 382210	21 mm
Art. 382220	22 mm
Art. 382240	24 mm

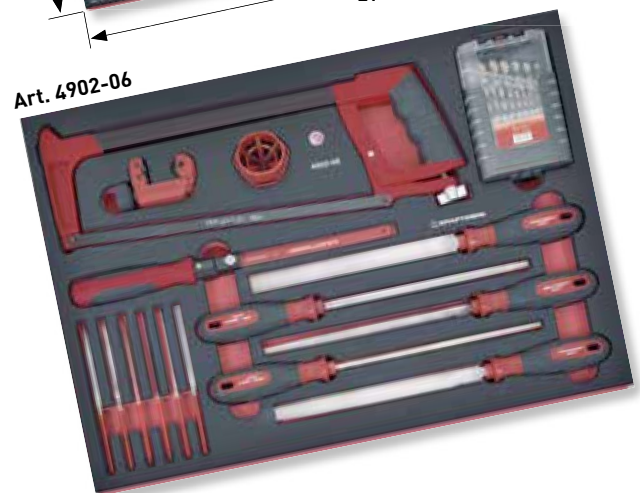
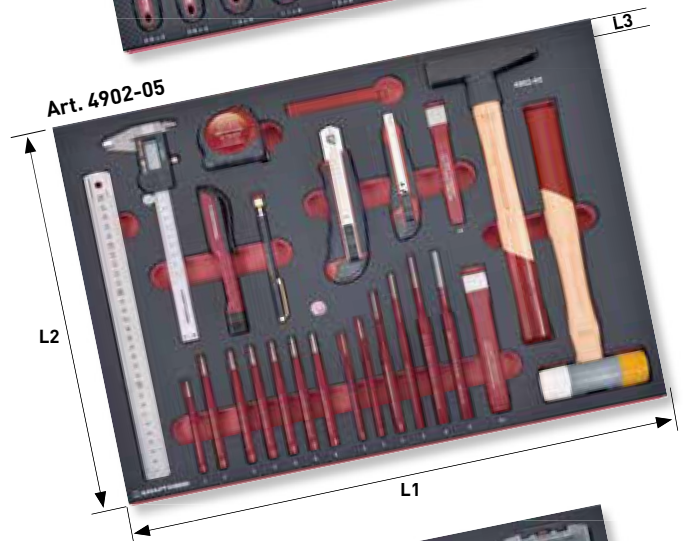
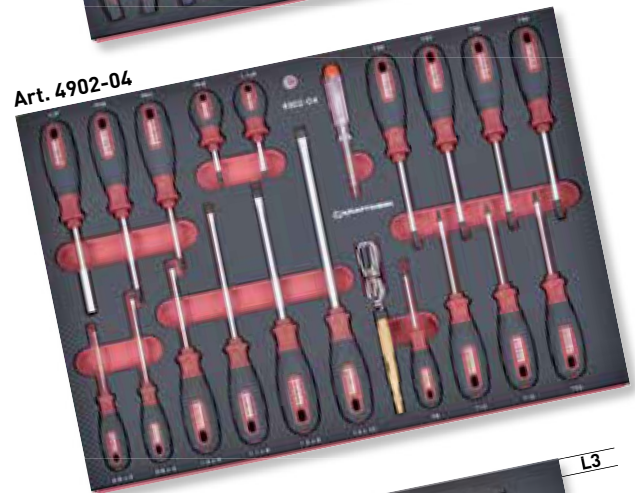

309
PGS



Werkzeug-Zusammenstellung

mit professionellen Werkzeugen, schüttelfest eingebettet in 6 Schubladen in speziell hochverdichteten Weich-Schaumstoff-Einlagen (EVA) mit einer dauerhaften Hartplastik-Oberschicht, die gereinigt werden kann.

Sélection d'outils professionnels

répartis dans 6 tiroirs garnis de nos inserts mousse (EVA) de haute densité avec revêtement renforcé garantissant ainsi une durée de vie plus longue et un nettoyage aisé.

Set utensili professionali

riposti in 6 esclusivi vassoi "anti-rovesciamento" realizzati in materiale espanso ad alta densità (EVA). Il top di questi vassoi è in laminato e ciò garantisce una maggior durata e una pulizia più facile.

Art.

4917

3907-1 / 3908 / 3934 / 2907

↕ L1 527 × L2 407 × L3 30 mm

COMPLETO EVA SERIE 4902



309
PCS

**Werkzeug-Zusammenstellung
mit Werkstattwagen**
*Assortiment d'outils
avec servantes*
**Assortimento di utensili
con carrelli**



3907-1



3908



2907



3934

Art.		
3907-4917	3907-1	6
3908-4917	3908	8
3934-4917	3934	7
2907-4917	2907	7



Steckschlüssel-Satz
Jeu de douilles
Assortimento di chiavi e bussole

Art.
4902-01

↔ L1 527 × L2 407 × L3 30 mm



- | | | | | | |
|--|----|--|--|-----------------|--|
| | 14 | 3.5-4-4.5-5-5.5-6-7-8
9-10-11-12-13-14 mm | | 17 | 10-11-12-13-14-15-16-17-18
19-21-22-24-27-30-32-34 mm |
| | 12 | 4-4.5-5-5.5-6-7-8-9
10-11-12-13 mm | | 9 | 10-13-14-15-16-17-18
19-22 mm |
| | 3 | 4-5.5-6.5 mm | | 2 | 16 mm / 21 mm |
| | 3 | PH 1-2-3 | | | ○ 1/2" ■ 1/2" |
| | 3 | PZ 1-2-3 | | 2 | 125 mm / 250 mm |
| | 8 | T8-T10-T15-T20
T25-T27-T30-T40 | | | ○ 3/8" ■ 1/2" |
| | 6 | 3-4-5-6-7-8 mm | | | ○ 1/2" ○ 5/16" |
| | | ○ 1/4" ○ 1/4" | | (60) Art. 4020B | |
| | | ○ 1/4" ■ 1/4" | | | +Nm |
| | 2 | 50 mm / 100 mm | | | |
| | | 150 mm | | | |
| | | 105 mm | | | |
| | | ○ 1/4" ■ 1/4" | | | |
| | | ■ 1/4" ■ 1/4" | | | |

- | | | |
|--|-----------------|-----|
| | (72) Art. 3799 | |
| | (60) Art. 4000B | +Nm |

- | | | |
|--|---|------------------------------------|
| | 6 | 4-4.5-5.5-6-6.5-8 mm |
| | 4 | PH 1-2-3-4 |
| | 4 | PZ 1-2-3-4 |
| | 8 | T8-T10-T15-T20-T-25-T27-T30-T40 |
| | 8 | T8-T10-T15-T20-T-25-T27-T30-T40 |
| | 6 | 3-4-5-6-7-8 mm |
| | 6 | 2-2.5-3-4-5-6 mm |
| | 6 | 5/64"-3/32"-7/64"-1/8"-9/64"-5/32" |
| | 3 | Nos. 6-8-10 |
| | 4 | Nos. 1-2-3-4 |
| | 4 | Nos. 4-6-8-10 |

1/4" 1/4" 1/4" 1/4"



45
PCS

Schraubenschlüssel- und Drehmomentschlüssel-Satz

Jeu de clés avec clé dynamométrique

Assortimento di chiavi e chiave dinamometrica

Art.

4902-02

↔ L1 527 × L2 407 × L3 30 mm

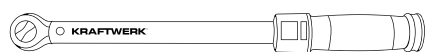

Art. 3235 C 1/2" 40-200 Nm / 30-150 Lb.ft



Art. 3602
1.5-2-2.5-3-4-5-6-7-8-10 mm

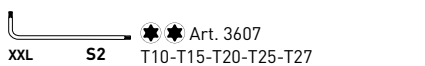

Art. 3607
T10-T15-T20-T25-T27
T30-T40-T45-T50

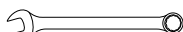

DIN 3113

Art. 3505	5.5 mm	Art. 3511	11 mm	Art. 3517	17 mm	Art. 3523	23 mm
Art. 3506	6 mm	Art. 3512	12 mm	Art. 3518	18 mm	Art. 3524	24 mm
Art. 3507	7 mm	Art. 3513	13 mm	Art. 3519	19 mm	Art. 3527	27 mm
Art. 3508	8 mm	Art. 3514	14 mm	Art. 3520	20 mm	Art. 3530	30 mm
Art. 3509	9 mm	Art. 3515	15 mm	Art. 3521	21 mm	Art. 3532	32 mm
Art. 3510	10 mm	Art. 3516	16 mm	Art. 3522	22 mm		



ERGOKRAFT

DIN 3117 / ISO 6787
Art. 3572 150 mm / 6"
Art. 3573 200 mm / 8"

13
PCS

Zangen-Satz

Jeu de pinces

Assortimento di pinze

Art.

4902-03

↔ L1 527 × L2 407 × L3 30 mm

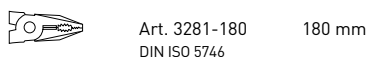
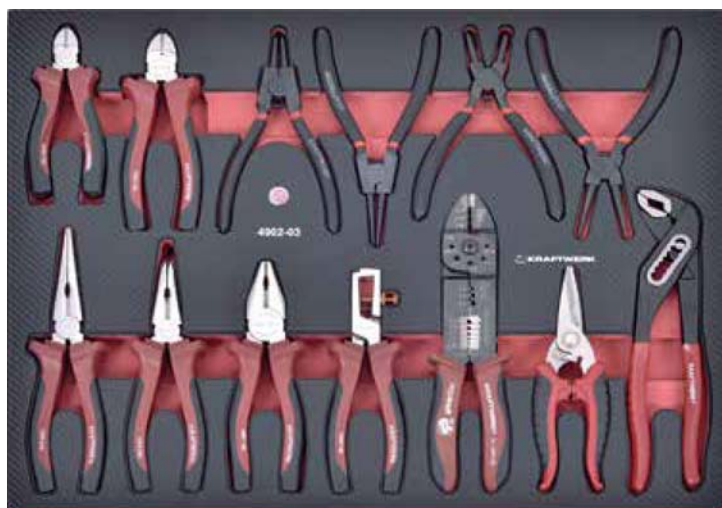

Art. 3281-180 180 mm
DIN ISO 5746

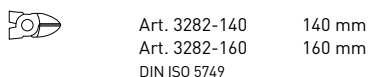

Art. 3282-140 140 mm
Art. 3282-160 160 mm
DIN ISO 5749

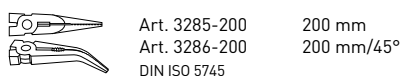

Art. 3285-200 200 mm
Art. 3286-200 200 mm/45°
DIN ISO 5745

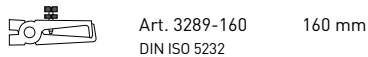

Art. 3289-160 160 mm
DIN ISO 5232



Art. 2221-250 250 mm
DIN ISO 8976

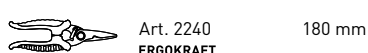

Art. 2240 180 mm
ERGOKRAFT



Art. 2212-A2 A2
DIN ISO 5254A



Art. 2213-A21 A21
DIN ISO 5254B



Ø 19-60 mm



Art. 2214-J2 J2
DIN ISO 5256C



Art. 2215-J21 J21
DIN ISO 5256D

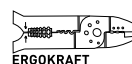

Art. 3290-230 230 mm
1.5 - 6 mm² 1.5 - 4-6 mm²











Schraubendreher-Satz
Jeu de tournevis
Assortimento di giraviti

Art.
4902-04

↔ L1 527 × L2 407 × L3 30 mm



- | | | | | | |
|--|-------------------------|--|------------------|---|-----------|
|  S2 | Art. 4110-1 0.6 × 3 mm |  S2 | Art. 4117-2 PH2 |  | Art. 2138 |
| | Art. 4110-2 0.8 × 4 mm | | |  | 100-250 V |
| | Art. 4110-3 1.0 × 5 mm |  S2 | Art. 4125-08 T8 |  | Art. 2139 |
| | Art. 4110-4 1.1 × 6 mm | | Art. 4125-10 T10 | | 12 V |
| | Art. 4110-5 1.2 × 8 mm | | Art. 4125-15 T15 | | |
| | Art. 4110-6 1.6 × 10 mm | | Art. 4125-20 T20 | | |
| | | | Art. 4125-25 T25 | | |
| | | | Art. 4125-27 T27 | | |
|  S2 | Art. 4115-1 PH1 | | Art. 4125-30 T30 | | |
| | Art. 4115-2 PH2 | | Art. 4125-40 T40 | | |
|  S2 | Art. 4112-2 1.1 × 6 mm |  | Art. 4128 1/4" | | |











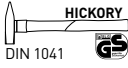



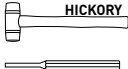
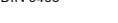

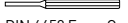



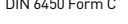

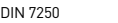

Schlag-/Schneid- und Messwerkzeug-Satz
Jeu d'outils de frappe, de coupe et de mesure
Assortimento di martelli, punzoni, scalpelli, cutter e metro

Art.
4902-05

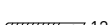
↔ L1 527 × L2 407 × L3 30 mm

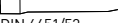

- | | | | | | | | | |
|--|-------------|---------|---|--------------------|---|------------------|---|----------------------------|
|  HICKORY
DIN 1041 | Art. 2303 | 300 g |  | Art. 1355-2 2 mm |  | Art. 3196 2000 g |  | Art. 3312 18 mm |
|  HICKORY | Art. 2336 | ∅ 35 mm |  | Art. 1355-3 3 mm |  | Art. 32065 |  | Art. 3314 18 mm |
|  | Art. 1350-2 | 2 mm |  | Art. 1355-4 4 mm |  | Art. 2976 |  | Art. 2972 150 mm × 0.01 mm |
|  | Art. 1350-3 | 3 mm |  | Art. 1358-1 No. 1 |  | Art. 3310 9 mm |  | DIGITAL 6" × 0.0005" |
|  | Art. 1350-4 | 4 mm |  | Art. 1358-2 No. 2 |  | Art. 3313 9 mm |  | 3 m × 16 m |
|  | Art. 1350-5 | 5 mm |  | Art. 3380-18 18 mm |  | | | |
|  | Art. 1350-6 | 6 mm |  | Art. 3380-22 22 mm | | | | |
|  | Art. 1350-8 | 8 mm | | | | | | |

35
PCS

Feilen-/Sägen- und Bohrer-Satz

Jeu de limes, de scies et de forets











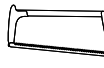

Assortimento di lime, seghetti e punte

Art.

4902-06

↕ L1 527 × L2 407 × L3 30 mm

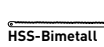

- | | | | | | |
|--|--------------------------------|--|----------------------------------|--|---|
|  | Art. 4320-1 320 mm
DIN 7261 |  | Art. 4321 |  | Art. 11904 1-1.5-2-2.5-3
DIN 338 N 3.5-4-4.5-5-5.5
6-6.5-7-7.5-8
8.5-9-9.5-10 mm |
|  | Art. 4320-2 320 mm
DIN 7261 |  | Art. 3305 300 mm |  | Art. 5433 3-30 mm CU |
|  | Art. 4320-3 320 mm
DIN 7261 |  | ERGOKRAFT Art. 3308-1 |  | Art. 5470 Ø 4-40 cm |
|  | Art. 4320-4 320 mm
DIN 7261 |  | HSS-Bimetall Art. 3316-24 300 mm | | |
|  | Art. 4320-5 320 mm
DIN 7261 | | | | |

12
PCS

T-Griff-Gelenkschlüssel-Satz extra lang

Jeu de clés articulées en T extra longues

Assortimento di chiavi esagonali snodate a T extra lunghi

Art.

4902-07

↕ L1 527 × L2 407 × L3 30 mm

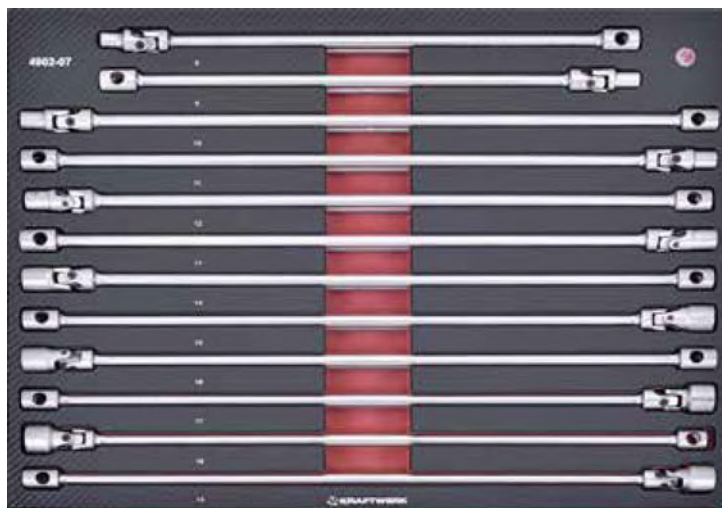

-  **XXL** DIN 896 / ISO 2236, 1085
- | | |
|--------------------|--------------------|
| Art. 2592-08 8 mm | Art. 2592-14 14 mm |
| Art. 2592-09 9 mm | Art. 2592-15 15 mm |
| Art. 2592-10 10 mm | Art. 2592-16 16 mm |
| Art. 2592-11 11 mm | Art. 2592-17 17 mm |
| Art. 2592-12 12 mm | Art. 2592-18 18 mm |
| Art. 2592-13 13 mm | Art. 2592-19 19 mm |





21
PCS

Steckschlüsselsatz für den Schwersteinsatz

mit Feinzahn-Umschaltknarre mit Stecknuss-Auswurf-Mechanismus. Verlängerungen mit Verriegelungs-System.

Jeu de douilles pour poids lourds

avec cliquet à denture fine avec mécanisme d'éjection de douilles et rallonges avec système de verrouillage.

Assortimento di chiavi a bussola per impieghi pesanti

con chiave a cricchetto a denti fini con meccanismo di sgancio rapido e sistema di bloccaggio.



Art.

4902-08

↔ L1 527 × L2 407 × L3 40 mm



16 19-21-22-23-24-26-27-29-30
32-35-36-38-41-46-50 mm

3 100-200-400 mm

460 mm



22
PCS

Steckschlüsselsatz für den Schwersteinsatz

mit Digital-Drehmoment-Adapter

Jeu de douilles pour poids lourds

avec adaptateur dynamométrique digital

Assortimento di chiavi a bussola per impieghi pesanti

con adattore dinamometrico digitale



Art.

4902-080

4081-34

4902-081

4081-341

↔ L1 527 × L2 407 × L3 40 mm



16 19-21-22-23-24-26-27-29-30
32-35-36-38-41-46-50 mm

3 100-200-400 mm

460 mm

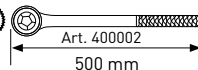

0 / Art. 4081-34



Art. **4081-34**
100-500 Nm (± 2%) / 73.8-369 Lb.ft
kg-m / kg-cm / lb-in / ft-lbs

4902-081 / Art. 4081-341



Art. **4081-341**
200-1000 Nm (± 2%) / 147.6-738 Lb.ft
kg-m / kg-cm / lb-in / ft-lbs



Steckschlüsselsatz für den Schwersteinsatz

mit fein verzahnter **Teleskop**-Auszug-Umschaltknarre mit Stecknuss-Auswurf-Mechanismus. Verlängerungen mit Verriegelungs-System

Jeu de douilles pour poids lourds

avec cliquet à denture fine avec manche télescopique et mécanisme d'éjection de douilles. Rallonges avec système de verrouillage

Assortimento di chiavi a bussola per impieghi pesanti

con chiave a cricchetto **estensibile** a denti fini con meccanismo di sgancio rapido e sistema di bloccaggio

Art.

4902-09

↔ L1 527 × L2 407 × L3 40 mm

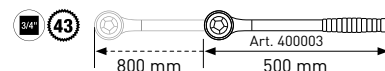

3/4" 43 16 19-21-22-23-24-26-27-29-30
32-35-36-38-41-46-50 mm

3 100-200-400 mm

460 mm



Steckschlüsselsatz für den Schwersteinsatz

mit Digital-Drehmoment-Adapter

Jeu de douilles pour poids lourds

avec adaptateur dynamométrique digital

Assortimento di chiavi a bussola per impieghi pesanti

con adattore dinamometrico digitale

Art.



4902-090

4081-34

4902-091

4081-341

↔ L1 527 × L2 407 × L3 40 mm



16 19-21-22-23-24-26-27-29-30
32-35-36-38-41-46-50 mm

3 100-200-400 mm

460 mm

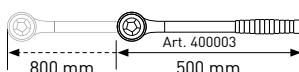

4902-090 / Art. 4081-34

3/4" 43 Art. 4081-34
100-500 Nm (± 2%) / 73.8-369 Lb.ft
kg-m / kg-cm / lb-in / ft-lbs

4902-091 / Art. 4081-341

3/4" 43 Art. 4081-341
200-1000 Nm (± 2%) / 147.6-738 Lb.ft
kg-m / kg-cm / lb-in / ft-lbs





Art. 4919-01



Art. 4919-02



Art. 4919-03

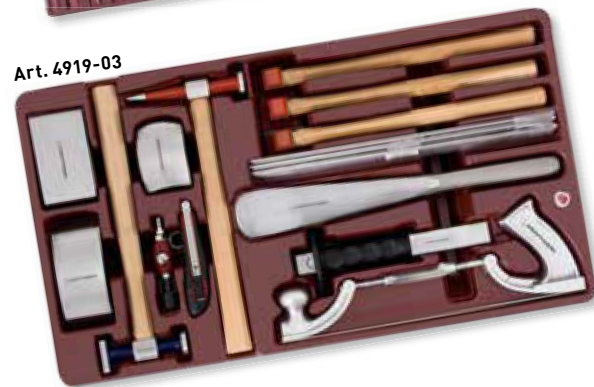

Service-Werkstattwagen



bestückt

Servante spéciale d'atelier

équipée

Carrello di servizio

con utensili

Art.			PCS
3917-4919	3917	4919-01, 4919-02	160

Karosserie-Werkstattwagen



universell bestückt mit Karosserie-Spezial-Werkzeugsatz in 3. Schublade

Chariot pour atelier de carrosserie

composition universelle avec en plus un jeu d'outils spécial carrosserie dans le 3ème tiroir

Carrello per carrozziere

con utensili universali e set di utensili speciali per carrozzerie nel 3° cassetto

Art.			PCS
3917-4919+3	3917	4919-01, 4919-02, 4919-03	176

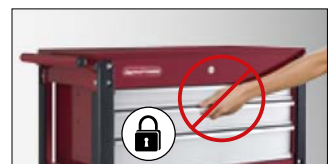

Schale mit Steck- und Schraubenschlüssel















































132
PCS

Coquille de clés et douilles

Assortimento di chiavi a bussola e chiavi combinate



-  14 3.5-4-4.5-5-5.5-6-7-8-9-10-11-12-13-14 mm
-  12 4-4.5-5-5.5-6-7-8-9-10-11-12-13 mm
-  3 4-5.5-6.5 mm
-  3 PH 1-2-3
-  3 PZ 1-2-3
-  8 T8-T10-T15-T20-T25-T27-T30-T40
-  6 3-4-5-6-7-8 mm
-   1/4"  1/4"
-   1/4"  1/4"
-  2 50 mm / 100 mm
-  150 mm
-  115 mm
-   1/4"  1/4"
-  7  T10-T15-T20-T25-T27-T30-T40
-   1/4"  1/4"
-   1/4"  1/4"
-   Art. 3200

-  17 10-11-12-13-14-15-16-17-18
19-21-22-24-27-30-32-34 mm
-  5 10-13-17-19-22 mm
-   1/2"  1/2"
-  2 125 mm / 250 mm
-   3/8"  1/2"
-   Art. 3220
-   Art. 3602
1.5-2-2.5-3-4-5-6-7-8-10 mm
-   Art. 3607
T10-T15-T20-T25-T27
T30-T40-T45-T50

-  DIN 3113
- Art. 3505 5.5 mm
- Art. 3506 6 mm
- Art. 3507 7 mm
- Art. 3508 8 mm
- Art. 3509 9 mm
- Art. 3510 10 mm
- Art. 3511 11 mm
- Art. 3512 12 mm
- Art. 3513 13 mm
- Art. 3514 14 mm
- Art. 3515 15 mm
- Art. 3516 16 mm
- Art. 3517 17 mm
- Art. 3518 18 mm
- Art. 3519 19 mm
- Art. 3520 20 mm
- Art. 3521 21 mm
- Art. 3522 22 mm
- Art. 3523 23 mm
- Art. 3524 24 mm

Art.

4919-01

**Schale mit Schraubendreher,
Zangen und Schlagwerkzeug**

28
PCS

Coquille de tournevis, pinces et outils de frappe

Assortimento di cacciaviti, pinze e martelli



DIN ISO 5746
Art. 3281-180 180 mm



DIN ISO 5749
Art. 3282-160 160 mm



DIN ISO 8976
Art. 3290-250 250 mm



DIN ISO 5745
Art. 3285-200 200 mm



DIN ISO 5232
Art. 3289-160 160 mm

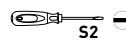

Art. 4110-1 0.6 x 3 mm
Art. 4110-2 0.8 x 4 mm
Art. 4110-3 1.0 x 5 mm
Art. 4110-4 1.1 x 6 mm
Art. 4110-5 1.2 x 8 mm



Art. 4112-2 1.1 x 6 mm

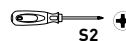

Art. 4115-1 PH1
Art. 4115-2 PH2

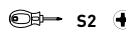

Art. 4117-2 PH2



Art. 2138 100-250 V



Art. 2139 12 V

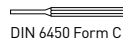

Art. 1350-2 2 mm
Art. 1350-3 3 mm
Art. 1350-4 4 mm
Art. 1350-5 5 mm
Art. 1350-6 6 mm
Art. 1350-8 8 mm

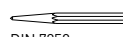

Art. 1358-2 No. 2
DIN 7250

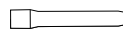

Art. 3380-18 18 mm
Art. 3380-22 22 mm
DIN 6451/53

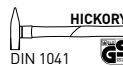

Art. 2305 500 g
DIN 1041

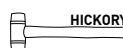

Art. 2336 Ø 35 mm



3 m x 16 m









Art.

4919-02

Karosserie-Spezial-Werkzeugschale
Coquille d'outils spécial carrosserie
Vassoio di utensili speciali per carrozziere

16
PCS



-  1 Handfaust Keilform
Tas de carrossier épinçoir
Tasso a cuneo
-  1 Handfaust Kommaform
Tas de carrossier virgule
Tasso a virgola
-  1 Handfaust Zehenform
Tas de carrossier américain
Tasso rettangolare bombato
-  1 Spann- und Schlichthammer
Marteau à planer et à débosseler
Martello per carrozziere
con testa piane tonda e quadra
-  1 Schlicht- und Treibhammer
Marteau à boule combi à débosseler
Martello per carrozziere
con testa tonda piana e penna a punta
-  1 Ausbeul- und Planierhammer geriffelt
Marteau cannelé à débosseler et planer
Martello per carrozziere
con testa quadra zigrinata
-  1 Ausbeul- und Planierhammer gerade
Marteau plan à débosseler et à planer
Martello per carrozziere
con testa quadra liscia
-  1 Ausbeul- und Planierhammer gewölbt
Marteau bombé à débosseler et à planer
Martello per carrozziere
con testa quadra liscia e convessa



-  1 Karosseriefeilen-Spannhalter 350 mm
Monture pour limes fraisées 350 mm
Portalima per carrozziere, piatta flessibile,
350 mm
-  3 Karosserie-Feilenblatt
Lime de carrossier
Lima per carrozziere,
-  1 Karosserie-Löffeleisen
Cuillère de carrosserie
Leva a cucchiaio carrozziere
-  1 Karosserie-Meissel
Burin de carrosserie
Scalpello extrapiatto con tagliente
diritto e paramano
-  1 Mini-Druckluft-Ausblaspistole
mit Turbo-Power-Düse
*Mini soufflette à air comprimé
avec buse turbo*
Mini pistola tascabile di soffiaggio, ad aria
compressa, con ugello effetto turbo.
-  1 Abbrechklingen-Messer
Cutter à lame sécable
Cutter universale a lame a settori

Art.

4919-03

Mehrzweck-Etagen-Transportwagen

- 3 grosse Tablare aus Polypropylène/Fiberglas
- sehr stabile Konstruktion mit Aluminiumstangen
- universell einsetzbar
- grosse Lenkrollen Ø 100 mm, davon 2 mit Feststellbremse
- Etagentragfähigkeit: 80 kg
- Wagentragfähigkeit: 160 kg

Chariot de transport à plateaux multi-usages

- 3 niveaux de stockage en polypropylène et fibre de verre
- Robuste, universel, tiges en aluminium
- Roues pivotantes de grand diamètre Ø 100 mm, dont 2 avec frein de blocage.
- Charge utile par plateau : 80 kg
- Charge utile pour l'ensemble : 160

Carrello aperto multiuso

- dotato di 3 grandi ripiani in polipropilene e lana di vetro
- costruzione molto solida per uso universale, aste in alluminio
- 4 ruote girevoli Ø 100 mm, di cui 2 con freno
- portata del ripiano: 80 kg
- portata totale del carrello: 160 kg



Art.

3912

	L1 / mm	L2 / mm	L3 / mm	⚖️ kg
	910	480	1040	320
A	660	390	300	160
B	660	390	300	80

Mehrzweck-Etagen-Transportwagen

mit Zubehörsatz zur Auflage von Fenster- und Windschutzscheiben.

Chariot de transport à plateaux multi-usages

avec kit d'accessoires pour la pose et la dépose des fenêtres et pare-brise.

Carrello aperto multiuso

con kit di accessori per il trasporto di finestre e parabrezza.



Art.



x4

3912A

3912

3912-98



Abfalleimer

für Mehrzweck-Etagen-Transportwagen 3912
aus öl- und säureresistentem Polypropylen

Poubelle

pour chariot de transport à plateaux multi-usages 3912
en polypropylène, résistant à l'huile et à l'acide

Pattumiera

per carrello aperto multiuso 3912 in polipropilene,
resistente agli olii ed agli acidi

Art.	
3912-99	3912

↕ L1 360 × L2 250 × L3 430 mm



19L



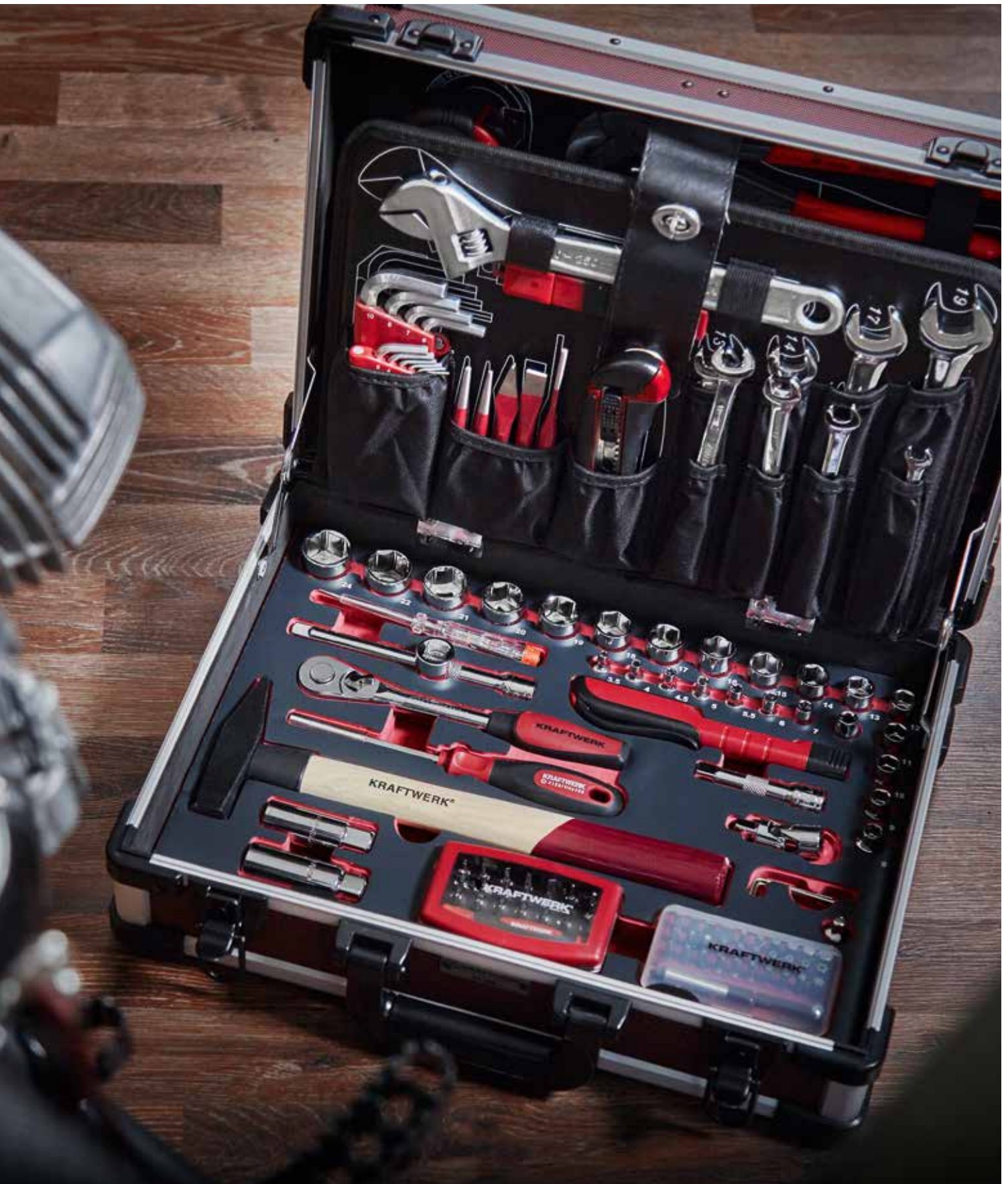







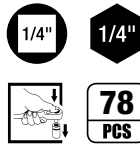







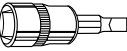

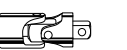

HIGHTECH Profi-Universal-Steckschlüssel-Koffer

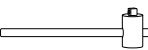
Coffret de douilles professionnel universel HIGHTECH

Valigetta universale di chiavi a bussola HIGHTECH per uso professionale

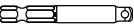

HIGHTECH FINE POWER

-   14 ○ 3.5-4-4.5-5-5.5-6-7-8
9-10-11-12-13-14 mm
-  12 ○ 4-4.5-5-5.5-6-7-8
9-10-11-12-13 mm
-  7 ☆ E4-E5-E6-E7-E8-E10-E11
-  3 ○ 4-5.5-6.5 mm
-  3 + PH 1-2-3
-  3 + PZ 1-2-3
-  8 ☆ T8-T10-T15-T20-T25-T27-T30-T40
-  6 ● 3-4-5-6-7-8 mm
-  6 ● M4-M5-M6-M7-M8-M10
-  ○ 1/4" ○ 1/4"
-  ○ 1/4" ■ 1/4"
-  2 50 mm / 100 mm
-  150 mm
-  110 mm
-  ○ 1/4" ■ 1/4"
-  120 Art. 4001 
-   7 ☆ T10-T15-T20-T25-T27-T30-T40
-  ● 1/4" ■ 1/4"

























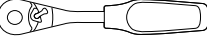

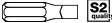
↕ 300 x 190 x 60 mm



Art.	○	●
4007	1/4"	1/4"

**Der KRAFTWERK-Klassiker
Steckschlüsselkasten**

*Le classique de KRAFTWERK
Coffret de douilles*

**Il classico di KRAFTWERK
Valigetta di chiavi a bussola**

-   14 3.5-4-4.5-5-5.5-6-7-8-9-10-11-12-13-14 mm
-   1/4"  1/4"
-   1/4"  1/4"
-  100 mm
-   1/4"
-   Art. 3200
-   2  5.5-6.5 mm
-  2  PH 1-2
-  2  PZ 1-2
-  6  T10-T15-T20-T25-T30-T40
-  5  3-4-5-6-8 mm

Art.		
3005	1/4"	1/4"



 194 x 133 x 35 mm



**Der kompakteste 1/4"-Satz der Welt
Allzweck-Steckschlüsselsatz**





















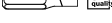

mit 72-Feinzahn-Umschaltknarre mit speziell kleinem und flachem Ratschenkopf in robuster ABS-mini-Box.



*Coffret 1/4" le plus compact du monde
Jeu de douilles multi-usages*

avec cliquet à denture fine de 72 dents, tête compacte et plate dans mini boîte solide en ABS.

**Il set da 1/4" piú compatto del mondo
Set di chiavi a bussola multi-uso**

con chiave a cricchetto con testa compatta e con movimento a 72 denti in robusta mini-box ABS.

-   14 3.5-4-4.5-5-5.5-6-7-8-9-10-11-12-13-14 mm
-   1/4"  1/4"
-   1/4"  1/4"
-  50 mm
-   Art. 4009
-   3  4-4.5-5.5 mm
-  3  PH 1-2-3
-  3  PZ 1-2-3
-  8  T8-T10-T15-T20-T25-T27-T30-T40
-  5  3-4-5-6-8 mm

Art.		
4033	1/4"	1/4"



 163 x 80 x 35 mm



Steckschlüssel-Koffer

Coffret de douilles

Valigetta di chiavi a bussola



COMPLETO

- 14 3.5-4-4.5-5-5.5-6-7-8-9-10-11-12-13-14 mm
- 12 4-4.5-5-5.5-6-7-8-9-10-11-12-13 mm
- 3 4-5-5-6.5 mm
- 3 PH 1-2-3
- 3 PZ 1-2-3
- 8 T8-T10-T15-T20-T25-T27-T30-T40
- 6 3-4-5-6-7-8 mm
- 1/4" 1/4"
- 1/4" 1/4"
- 2 50 mm / 100 mm
- 150 mm
- 115 mm
- 1/4"
- 45 Art. 3200
- 7 T10-T15-T20-T25-T27-T30-T40
- 1/4" 1/4"
- 1/4" 1/4"



421 x 200 x 68 mm

Art.		
4900-01K	1/4"	1/4"

Steckschlüsselsatz

in solider Metallkassette

Jeu de douilles

dans coffret métallique résistant

Set di chiavi a bussola

in cassetta metallica solida



- 12 4-4.5-5-5.5-6-7-8-9-10-11-12-13 mm
- 1/4" 1/4"
- 1/4" 1/4"
- 50 mm
- 3/8" 1/4"
- 1/4"
- 3 1.5-2-2.5 mm
- 45 Art. 3200



245 x 130 x 40 mm

Art.		
2003	1/4"	1/4"

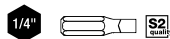

- 5 3-4-5-6-8 mm
- 3 4-5-5-6.5 mm
- 2 PH 1-2
- 2 PZ 1-2
- 7 T10-T15-T20-T25-T27-T30-T40

COMBI-Steckschlüsselsatz

in solider Zweikomponenten-Box

Jeu de douilles COMBI

dans une boîte résistante multi-empreinte bi-matière



Set di chiavi a bussola COMBI

in una pratica custodia bimatériale

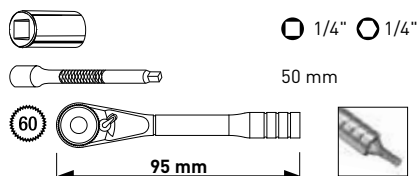
- 1/4"  13
- mm 4-4.5-5-5.5-6-7-8-9-10-11-12-13-14 mm
- inch 5/32"-7/32"-1/4"-5/16"-11/32"
3/8"-7/16"-15/32"-1/2"-9/16"
- TX E5-E6-E8-E10-E12-E14-E16-E18
- XZN M5-M6-M8-M10-M12-M14-M16-M18



- 1/4"  2
- 2 4-5.5 mm
- 2 PH 1-2
- 2 PZ 1-2
- 4 T15-T20-T25-T30
- 2 3-4 mm

Art.		
4004	1/4"	1/4"

COMBI-Steckschlüsselsatz

mit Finger-Umschaltknarre

Jeu de douilles COMBI multi-empreintes

avec cliquet à doigt



Set di chiavi a bussola COMBI

con chiave a cricchetto svita tutto

- 1/4"  6
- mm 4-5-6-8-10-13 mm
- inch 5/32"-3/16"-5/16"-3/8"-1/2"
- TX E5-E8-E10-E12
- XZN M5-M6-M8-M10-M12-M16



- 1/4"  2
- 2 5.5-6.5 mm
- 2 PH 1-2
- 2 PZ 1-2
- 6 T10-T15-T20-T25-T30-T40
- 4 3-4-5-6 mm

Art.		
38005	1/4"	1/4"



165 x 85 x 35 mm

ABS



Stecknuss- und Bit-Satz

















aus rostfreiem Stahl



Jeu de douilles et embouts

en acier inoxydable

Set di chiavi a bussola ed inserti

in acciaio inossidabile

-   13 4-4.5-5-5.5-6-7-8-9
10-11-12-13-14 mm
 -   2  4-5.5-6.5 mm
 - 4  PH1 - 2x PH2 - PH3
 - 4  PZ1 - 2x PZ2 - PZ3
 - 7  T10-T15-T20-T25-T27-T30-T40
 - 7  T10-T15-T20-T25-T27-T30-T40
 - 5  3-4-5-6-8 mm
-   1/4"  1/4"
-   1/4"  1/4"

Art.		
4003	1/4"	1/4"



inox



 165 x 85 x 35 mm

INOX-Werkzeuge – zur Vermeidung von Fremdrost

Outils en Inox pour prévenir la corrosion





















Utensili in acciaio inossidabile per prevenire di corrosione della superficie

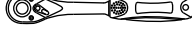

ABS

Steckschlüssel-Satz

Jeu de douilles

Set di chiavi a bussola

-   10 5.5-6-7-8-9-10
11-12-13-14 mm
-   1/4"  1/4"
-   1/4"  1/4"
-   1/4"
-  2 50 / 100 mm
-  
-    4  3-4-5-6 mm
- 4  PH1 - 2x PH2 - PH3
- 2  PZ1-PZ2-PZ3
- 7  T10-T15-T20-T25-T27-T30-T40
- 4  3-4-5-6 mm

Art.		
99073	1/4"	1/4"



 197 x 90 x 50 mm

Steckschlüssel-Satz

in robustem Metallkoffer mit Kantenstossschutz aus Hartplastik.

















Jeu de douilles

dans un coffret métallique, très solide grâce à sa protection antichoc en plastique dur.

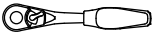
Set di chiavi a bussola

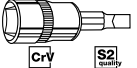
in solida valigetta metallica con protezione degli spigoli in materiale plastico.



		14	○	3.5-4-4.5-5-5.5-6-7-8 9-10-11-12-13-14 mm
		5	○	5.5-7-8-10-13 mm
			○	1/4" ○ 1/4"
			○	1/4" ■ 1/4"
			○	1/4" ■ 1/4"
		2		50 mm / 100 mm
				150 mm
			○	1/4" ○ 1/4"
		Art. 3200		
		3	●	4-5.5-6.5 mm
		3	+	PH 1-2-3
		3	+	PZ 1-2-3
		8	★	T8-T10-T15-T20-T25-T27-T30-T40
		6	●	3-4-5-6-7-8 mm
		7	★	T10-T15-T20-T25-T27-T30-T40
		4	●	1.27-1.5-2-2.5 mm
			●	1/4" ■ 1/4"



288 x 137 x 48 mm

Art.	○	●
2004	1/4"	1/4"

HIGHTECH Profi-Universal-Steckschlüssel-Koffer

Coffret de douilles professionnel universel HIGHTECH

Valigetta universale di chiavi a bussola HIGHTECH per uso professionale



HIGHTECH FINE POWER



- 18
○ 6-7-8-9-10-11-12-13-14-15
16-17-18-19-20-21-22-24 mm
- 10
○ 10-11-12-13-14-15-17-18-19-22 mm
- 4
14-16-18-21 mm
- 12
⊗ E4-E5-E6-E7-E8-E10-E11
E12-E14-E16-E18-E20
- 12
⊛ T8-T10-T15-T20-T25-T27
T30-T40-T45-T50-T55-T60
- 7
⬢ 3-4-5-6-7-8-10 mm
- 3/8" ○ 5/16"
- 3/8" ■ 1/4"
- 3/8" ■ 3/8"
- 75 mm / 250 mm
- 1/2" ■ 3/8"
- Art. 4011
- 5
⊖ 5.5-6.5-8-10-12 mm
- 4
⊕ PH 1-2-3-4
- 4
⊕ PZ 1-2-3-4
- 12
⊛ T10-T15-T20-T25-T27-T30
T40-T45-T50-T55-T60-T70
- 5
⬢ M5-M6-M8-M10-M12
- ⬢ 1/4" ■ 3/8"

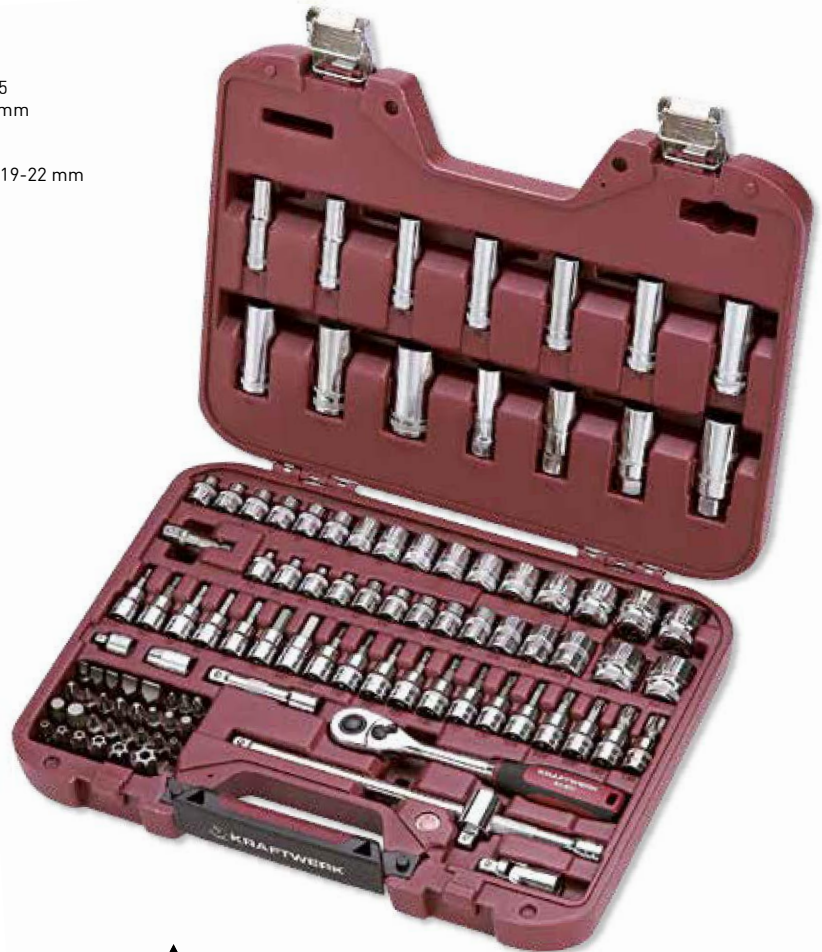

400 x 290 x 80 mm

Art.	○	⬢
4017	3/8"	5/16"

Steckschlüsselsatz













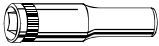









in solider Metallkassette

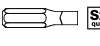

Jeu de douilles

dans coffret métallique résistant

Set di chiavi a bussola

in cassetta metallica solida

-   15 6-7-8-9-10-11-12-13-14
15-16-17-18-19-22 mm
-  4 10-13-17-19 mm
-  2 16 mm / 21 mm
-   
-   
-  2 75 mm / 250 mm
-   
-   Art. 3210
-    4  4-5-5-6.5-8 mm
- 3  PH 1-2-3
- 3  PZ 1-2-3
- 7  T10-T15-T20-T25-T27-T30-T40
- 6  3-4-5-6-7-8 mm

Art.		
2013	3/8"	1/4"













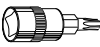











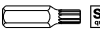

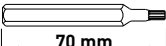

 350 x 195 x 50 mm

HIGHTECH Profi-Universal-Steckschlüssel-Koffer

Coffret de douilles professionnel universel HIGHTECH

Valigetta universale di chiavi a bussola HIGHTECH per uso professionale

-   12  E4-E5-E6-E7-E8-E10-E11
E12-E14-E16-E18-E20
-  12  T8-T10-T15-T20-T25-T27
T30-T40-T45-T50-T55-T60
-   
-   
-    7  T10-T15-T20-T25-T27-T30-T40
-    4  T45-T50-T55-T60
-    5  M5-M6-M8-M10-M12
-   

Art.		
4013	3/8"	1/4" + 5/16"





















HIGHTECH



 260 x 160 x 60 mm

Steckschlüssel-Satz
Coffret de douilles
Set di chiavi a bussola

- | | | | |
|---|---|---------------|--|
| 1/4" |  | 14 | 3.5-4-4.5-5-5.5-6-7-8
9-10-11-12-13-14 mm |
| |  | | ○ 1/4" ○ 1/4" |
| |  | | ○ 1/4" ■ 1/4" |
| |  | 2 | 50 mm / 100 mm |
| |  | | ○ 1/4" ■ 3/8" |
| 3/8" |  | 14 | 10-13-15-16-17-18-19
20-21-22-24 mm |
| |  | | ○ 3/8" ■ 3/8" |
| |  | 2 | 75 mm / 250 mm |
| |  | | ○ 1/2" ■ 3/8" |
| |  | | Art. 3200 |
| 1/4" |  | 4 | 4.5-5-6.5-8 mm |
| |  | 4 | PH 0-1-2-3 |
| |  | 3 | PZ 1-2-3 |
| |  | 7 | T10-T15-T20-T25-T27-T30-T40 |
| |  | 7 | T10-T15-T20-T25-T27-T30-T40 |
| |  | 6 | 3-4-5-6-7-8 mm |
| |  | | ● 1/4" ■ 1/4" |
|  | | ● 1/4" ○ 1/4" | |

Art.	○	●
3035	1/4" + 3/8"	1/4"

Der kompakteste 1/4"+3/8"-Satz!









Steckschlüsselsatz mit zwei 72-Feinzahn-Umschaltknarren mit schmalem Ratschenkopf in robuster ABS-Box.

Le jeu 1/4"+3/8" le plus compact !

Jeu de douilles eXtreme avec deux cliquets à denture et tête fines de 72 dents dans boîte solide en ABS.

Il più compatto set di bussole da 1/4"+3/8"!

Due chiavi a cricchetti eXtreme a 72 denti fini.

- | | | | |
|------|---|----|--|
| 1/4" |  | 14 | 3.5-4-4.5-5-5.5-6-7-8-9
10-11-12-13-14 mm |
| |  | | ○ 1/4" ○ 1/4" |
| |  | | ○ 1/4" ■ 1/4" |
| |  | | 100 mm |
| |  | | ○ 3/8" ■ 1/4" |
| 3/8" |  | 12 | 10-13-14-15-16-17-18-19
20-21-22-24 mm |
| |  | 2 | 16 mm / 21 mm |
| |  | | Art. 4009 |



Art.	○
4045	1/4" + 3/8"

1/4" 3/8" 1/4"  69 PCS



ABS

380 x 212 x 55 mm





1/4" 3/8"  37 PCS



ABS

305 x 140 x 42 mm

- | | |
|--|---------------|
|  | ○ 3/8" ■ 3/8" |
|  | 150 mm |
|  | ○ 1/2" ■ 3/8" |

  Art. 4019

HIGHTECH Profi-Universal-Steckschlüssel-Koffer











mit langen Schlag-Steckschlüsseln

Coffret de douilles professionnel universel HIGHTECH

avec douilles impact longues

Valigetta universale di chiavi a bussola HIGHTECH per uso professionale

con chiavi a bussola tipo lungo a macchina

		19	○	8-10-11-12-13-14-15-16-17-18 19-20-21-22-24-27-30-32-34 mm
		6	○	10-13-17-19-21-22 mm
		4		14-16-18-21 mm
		8	⊕	E10-E12-E14-E16-E18-E20-E22-E24
			○	1/2" ■ 1/2"
			○	1/2" ■ 3/8"
		2		125 mm / 250 mm
		Art. 4021		

Art.	○
4027	1/2"

Steckschlüsselsatz









in solider Metallkassette

Jeu de douilles

dans coffret métallique résistant

Set di chiavi a bussola

in cassetta metallica solida

		15	○	10-11-12-13-14-15-16-17-18 19-22-24-27-30-32 mm
		2		16 mm / 21 mm
			○	1/2" ■ 1/2"
		2		125 mm / 250 mm
			○	3/8" ■ 1/2"
		Art. 3220		

Art.	○
2023	1/2"



HIGHTECH FINE POWER

42
PCS



↕ 360 x 260 x 95 mm



22
PCS



↕ 350 x 195 x 50 mm

TX-Bit-Stecknuss-Satz

Jeu de douilles-embouts TX

Set di chiavi a bussola con inserto TX

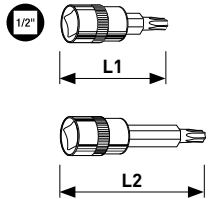

12 ● T10-T15-T20-T25-T27-T30
T40-T45-T50-T55-T60-T70

11 ● T10-T15-T20-T25-T27-T30
T40-T45-T50-T55-T60

Art.	Ø	L1 / L2
2025	1/2"	55 / 100 mm

371 x 156 x 42 mm

Bit-Stecknuss-Satz Innensechskant und XZN-Vielzahn

Jeu de douilles-embouts hexagonales et denture multiple XZN

Set di chiavi a bussola con inserto esagonale e XZN

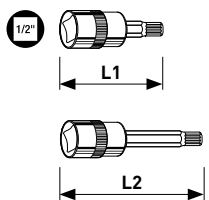

6 ● 5-6-7-8-10-12 mm

5 ● M5-M6-M8-M10-M12

6 ● 5-6-7-8-10-12 mm

5 ● M5-M6-M8-M10-M12

Art.	Ø	L1 / L2
2026	1/2"	55 / 100 mm

371 x 156 x 42 mm

HIGHTECH Profi-Universal-Steckschlüssel-Koffer

mit langen Schlag-Steckschlüsseln

Coffret de douilles professionnel universel HIGHTECH

avec douilles impact longues

Valigetta universale di chiavi a bussola HIGHTECH per uso professionale

con chiavi a bussola tipo lungo a macchina

1/4"

1/2"

5/16"



133
PCS

HIGHTECH FINE POWER

- 14 3.5-4-4.5-5-5.5-6-7-8
9-10-11-12-13-14 mm
- 12 4-4.5-5-5.5-6-7-8
9-10-11-12-13 mm
- 7 E4-E5-E6-E7-E8-E10-E11
- 3 4-5.5-6.5 mm
- 2 PH 1-2
- 3 PZ 0-1-2
- 8 T8-T10-T15-T20-T25-T27-T30-T40
- 6 3-4-5-6-7-8 mm
- 5 M4-M5-M6-M7-M8

- 1/4" 1/4"

- 1/4" 1/4"

- 2 50 mm / 100 mm

- 150 mm

- 110 mm

- 1/4" 1/4"

- Art. 4001

- 7 T10-T15-T20-T25-T27-T30-T40

- 1/4" 1/4"

- 16 10-13-14-15-16-17-18-19
20-21-22-24-27-30-32-34 mm

- 5 15-17-19-21-22 mm

- 4 14-16-18-21 mm

- 7 E12-E14-E16-E18-E20-E22-E24

- 4 M10-M12-M14-M16

- 1/2" 1/2"



460 x 350 x 90 mm

- 1/2" 5/16"

- 1/2" 3/8"

- 2 125 mm / 250 mm

- Art. 4021

- 3 8-10-12 mm

- 2 PH 3-4

- 2 PZ 3-4

- 5 T45-T50-T55-T60-T70

- 3 10-12-14 mm

Art.		
4037	1/2" + 1/4"	5/16"

Steckschlüssel-Satz

in solider Metallkassette









Jeu de douilles

dans coffret métallique résistant

Set di chiavi a bussola



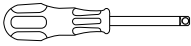

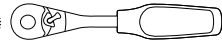

in cassetta metallica solida



		12	4-4.5-5-5.5-6-7-8-9-10-11-12-13 mm
		3	8-10-13 mm
			○ 1/4" ○ 1/4"
			○ 1/4" ■ 1/4"
			50 mm
			115 mm
			■ 1/4"
		Art. 3200	

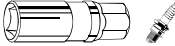

↕ 435 x 265 x 50 mm

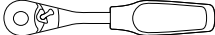
		11	14-15-16-17-18-19-22-24-27-30-32 mm
		2	17 mm / 19 mm
		2	16 mm / 21 mm
			○ 1/2" ○ 5/16"
			○ 1/2" ■ 1/2"
		2	125 mm / 250 mm
		Art. 3220	

		3	⊖ 4-5.5-6.5 mm
		2	⊕ PH 1-2
		2	⊕ PZ 1-2
		6	⊕ T10-T15-T20-T25-T27-T30
		4	● 3-4-5-6 mm

		2	⊖ 8-10 mm
		2	⊕ PH 3-4
		2	⊕ PZ 3-4
		4	⊕ T40-T45-T50-T55
		2	● 8-10 mm

Art.	○	●
2033	1/4" + 1/2"	1/4" + 5/16"

COMBI Universal-Steckschlüsselkoffer

mit Gabelringschlüssel und 2 Teleskop-Umschaltknarren

Coffret universel de douilles COMBI multi-empreintes

2 cliquets extensibles et clés mixtes

Valigetta universale di chiavi a bussola COMBI

con 2 chiavi a cricchetto estensibili e chiavi combinate



- 1/4"**
- 13 **mm** 4-4.5-5-5.5-6-7-8-9-10-11-12-13-14 mm
 - inch** 5/32"-7/32"-1/4"-5/16"-11/32"-3/8"-7/16"
15/32"-1/2"-9/16"
 - TX** E5-E6-E8-E10-E12-E14-E16-E18
 - XZN** M5-M6-M8-M10-M12-M14-M16-M18

- 1/4" 1/4"
- 1/4" 1/4"
- 2 50 mm / 100 mm
- 150 mm
- 1/4"

- Art. 2000
- 72** 150-200 mm

- 1/2"**
- 12 **mm** 15-16-17-18-19-20-21-22-24-27-30-32 mm
 - inch** 19/32"-5/8"-11/16"-3/4"-25/32"-13/16"-7/8"
15/16"-1-1/16"-1-3/16"-1-1/4"
 - TX** E20-E22-E24-E26-E28-E30-E34-E38-E40

- 2 16 mm / 21 mm
- 1/2" 1/2"
- 2 125 mm / 250 mm
- 1/2" 3/8"

- Art. 2020
- 72** 305-445 mm

- 1/4"**
- 4 4.5-5-6.5-8 mm
 - 4 PH 0-1-2-3
 - 3 PZ 1-2-3
 - 7 T10-T15-T20-T25-T27-T30-T40
 - 7 T10-T15-T20-T25-T27-T30-T40
 - 6 3-4-5-6-7-8 mm

- 1/4" 1/4"
- 1/4" 1/4"
- 9 8-10-11-12-13-14-17-19-22 mm



435 x 350 x 69 mm

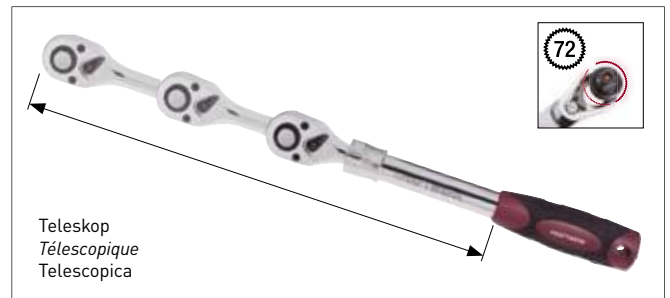

Art.	<input type="checkbox"/>	<input type="checkbox"/>
2034	1/4" + 1/2"	1/4"

Steckschlüssel-Satz

in robustem Metallkoffer mit Kantenstossschutz aus Hartplastik

























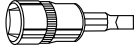

Jeu de douilles

dans un coffre métallique, très solide grâce à sa protection antichoc en plastique dur

Set di chiavi a bussola

in solida valigetta metallica con protezione degli spigoli in materiale plastico



-   13 3.5-4-4.5-5-5.5-6-7-8-9
10-11-12-13 mm
-   1/4"  1/4"
-   1/4"  1/4"
-   1/4"  1/4"
-  2 50 mm / 100 mm
-   1/4"
-   Art. 3200 
-  3  4-5-5-6.5 mm
-  3  PH 1-2-3
-  3  PZ 1-2-3
-  8  T8-T10-T15-T20-T25-T27-T30-T40
-  5  3-4-5-6-8 mm

-   7  T10-T15-T20-T25-T27-T30-T40

-   12 14-15-16-17-18-19-21
22-24-27-30-32 mm



-   2 16 mm / 21 mm

-   1/2"  1/2"

-   3/8"  1/2"

-  2 125 mm / 250 mm



-   Art. 3220 

-  4  1.27-1.5-2-2.5 mm



450 x 190 x 57 mm



Art.		
2032	1/4" + 1/2"	1/4"





Steckschlüssel-Koffer für den Schwersteinsatz

Feinzahn-Umschaltknarren mit Stecknuss-
Auswurf-Mechanismus und Verlängerungen
mit Verriegelungs-System

Coffrets de douilles pour poids lourds

*Cliquets à denture fine avec mécanisme
d'éjection de douilles et rallonges avec système
de verrouillage*

Valigetta di chiavi a bussola per impieghi pesanti

Chiavi a cricchetto con meccanismo di sgancio
rapido e sistema di bloccaggio

Steckschlüssel-Koffer

mit Umschaltknarre ohne Teleskop-Auszug





Coffret de douilles

avec cliquet sans fonction télescopique

Set di chiavi a bussola

con chiave a cricchetto senza meccanismo estensibile

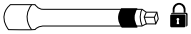

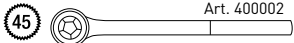
		16	19-21-22-23-24-26-27-29 30-32-35-36-38-41-46-50 mm
		3	100-200-400 mm
			460 mm
			500 mm

Art. 400002



535 x 383 x 100 mm

Art.	□
2056	3/4"

Steckschlüssel-Koffer

mit Teleskop-Auszug-Umschaltknarre

Coffret de douilles

Cliquet avec manche télescopique

Set di chiavi a bussola

con chiave cricchetto estensibile



16 19-21-22-23-24-26-27-29
30-32-35-36-38-41-46-50 mm

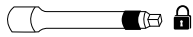

3 100-200-400 mm

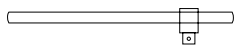

460 mm

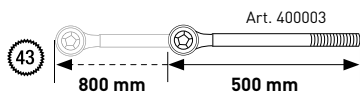

Art. 400003

800 mm 500 mm



Art.	○
2057	3/4"



535 x 383 x 100 mm

Steckschlüssel-Satz

mit Teleskop-Auszug-Umschaltknarre, in solidem Metallkoffer

Jeu de douilles

Cliquet avec manche télescopique, coffret métallique robuste

Set di chiavi a bussola

con chiave a cricchetto estensibile, in valigetta solida di metallo



17 36-38-41-46-50-54-55-58-60
63-65-67-70-71-75-77-80 mm



2 200 mm / 400 mm



○ 1" ■ 1"

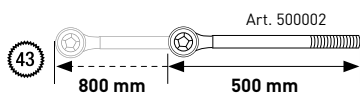

Art. 500002

800 mm 500 mm

Art.	○
2053	1"



700 x 280 x 108 mm

Durchgangs-Steckschlüsselsätze

1. Der durchgehende Ratschenkopf, die durchgehenden Stecknüsse und Verlängerungen ermöglichen das Schrauben auf langen Bolzen und Gewindestangen. Keine tiefen Stecknüsse nötig.
2. Das spezielle Ratschensystem erhöht das Drehmoment bis zu 40%. 72-Zahn-Umschaltknarre reduziert den Rückholwinkel auf nur 5°
3. Reduktion der Bauhöhe um mind. 50% und des Kopfdurchmessers um mind. 20%.
4. Verwendung von normalen Stecknüssen 1/4", 3/8" und 1/2" mittels Adapter mit Auswurf.



Jeux de douilles traversantes

1. La tête du cliquet, les douilles et les rallonges traversantes permettent le vissage et dévissage des boulons longs et des tiges filetées. L'utilisation de douilles longues n'est alors plus nécessaire.
2. Le système spécial et unique de ce cliquet augmente la force de serrage d'environ 40%. Le cliquet de 72 dents réduit l'angle de reprise à 5°.
3. Réduction de la hauteur de 50% et de l'épaisseur de 20%.
4. Utilisation de douilles standard avec des adaptateurs à éjection 1/4", 3/8" et 1/2".

Set di chiavi a bussola passanti

1. La testa passante della chiave a cricchetto permette il serraggio di viti lunghe e prigionieri. L'utilizzo di bussole lunghe non sarà più necessario.
2. Questa speciale chiave a cricchetto aumenta la potenza di serraggio del 40% rispetto alle chiavi a cricchetto standard. La testa con movimento a 72 denti riduce l'angolo di ripresa a soli 5°.
3. Lo spessore complessivo è ridotto del 50% e del 20% in larghezza.
4. Permette l'utilizzo di bussole standard ed inserti grazie a semplici adattatori a sgancio rapido da 1/4", 3/8" e da 1/2".

Durchgangs-Steckschlüssel-Satz

Jeu de douilles traversantes

Set di chiavi a bussola passanti

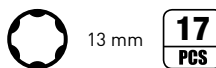
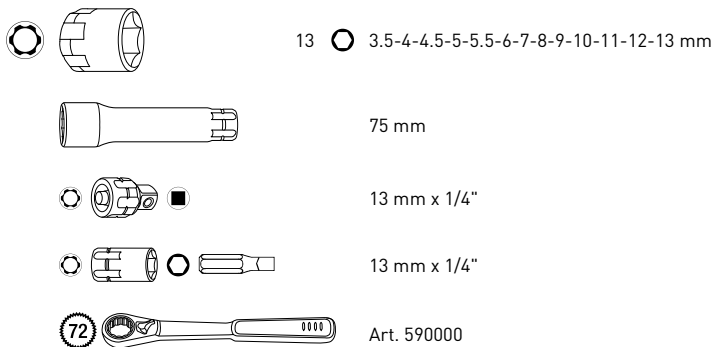

163 x 80 x 35 mm

Art.	
4002	13 mm

Durchgangs-Steckschlüssel-Satz
Jeu de douilles traversantes
Set di chiavi a bussola passanti

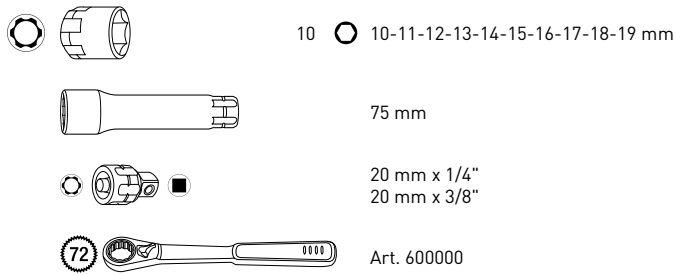

Art.	○
4012	20 mm

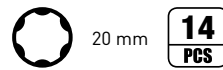

↕ 305 x 140 x 42 mm

Durchgangs-Steckschlüssel-Satz
Jeu de douilles traversantes
Set di chiavi a bussola passanti

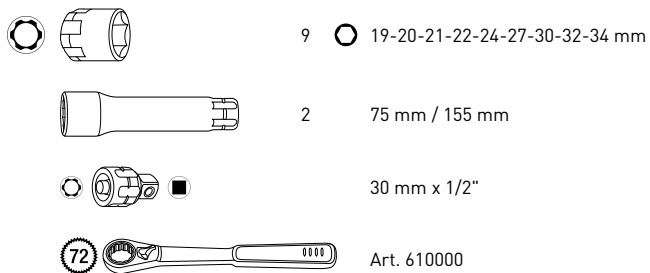

Art.	○
4022	30 mm

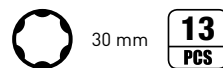

↕ 380 x 210 x 55 mm

Schlag-Steckschlüssel-Satz
Jeu de douilles impact
Set di chiavi a bussola a macchina

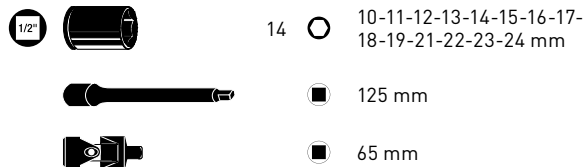

Art.
380005

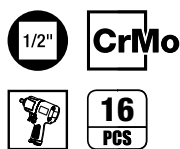

Schlag-Steckschlüssel-Satz, lang
mit Kunststoff-Einsatz zum Schutz der Radmutter und Kunststoff-Hülse für Alufelgen

Jeu de douilles longues impact
avec insert en matière synthétique pour protection des écrous de roue et manchon plastique pour jantes alliages

Set di chiavi a bussola tipo lungo a macchina
con inserto in plastica per la protezione dei dadi ruote e rivestite in plastica per cerchi in lega

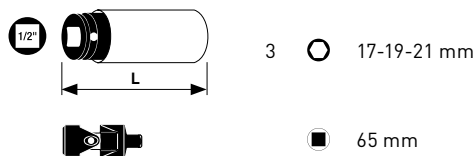

Art.	L mm
3083	85



AUTOMOTIVE



Schlag-Steckschlüssel-Satz, lang
mit Kunststoff-Einsatz zum Schutz der Radmutter und Kunststoff-Hülse für Alufelgen

Jeu de douilles longues impact
avec insert en matière synthétique pour protection des écrous de roue et manchon plastique pour jantes alliages

Set di chiavi a bussola tipo lungo a macchina
con inserto in plastica per la protezione dei dadi ruote e rivestite in plastica per cerchi in lega

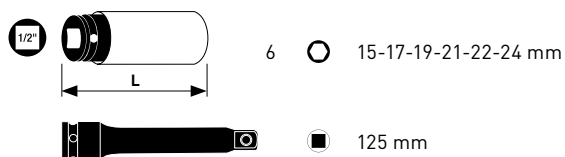

Art.	L mm
381005	85



AUTOMOTIVE



Schlag-Steckschlüssel-Satz TX
Jeu de douilles impact TX
Set di chiavi a bussola a macchina TX



12 T10-T15-T20-T25-T27-T30
T40-T45-T50-T55-T60-T70

Art.	L mm
3084	78



210 x 145 x 50 mm

Schlag-Steckschlüssel-Satz Innensechskant
Jeu de douilles impact hexagonales
Set di chiavi a bussola a macchina esagonale

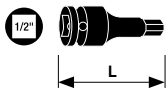

12 3-4-5-6-7-8-9-10
12-14-16-17 mm

Art.	L mm
3086	78



210 x 145 x 50 mm

Schlag-Steckschlüssel-Satz Vielzahn XZN
Jeu de douilles impact à denture multiple XZN
Set di chiavi a bussola a macchina XZN



210 x 145 x 50 mm

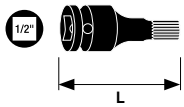

10 M4-M5-M6-M8-M9-M10
M12-M14-M16-M18

Art.	L mm
3087	78

Schlag-Steckschlüssel-Satz RIBE
Jeu de douilles impact RIBE
Set di chiavi a bussola a macchina RIBE



210 x 145 x 50 mm

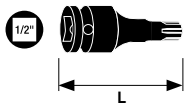

10 RM4-RM5-RM6-RM7-RM8-RM9
RM10-RM12-RM13-RM14

Art.	L mm
3089	78

Schlag-Steckschlüssel-Satz
Coffret de douilles impact
Set di chiavi a bussola a macchina

  8  26-27-29-30-32-35-36-38 mm

Art.

400005

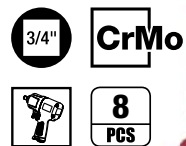

 465 x 186 x 78 mm

Schlag-Steckschlüssel-Satz, lang
Coffret de douilles longues impact
Set di chiavi a bussola tipo lungo a macchina

  8  26-27-29-30-32-35-36-38 mm

Art.

400015

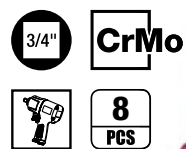

 465 x 186 x 78 mm

Schlag-Steckschlüssel-Satz, lang
Coffret de douilles longues impact
Set di chiavi a bussola tipo lungo a macchina

  7  24-27-30-32-33-36-38 mm

Art.

500015

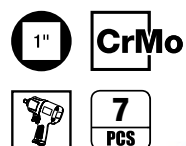

 465 x 186 x 78 mm

HIGHTECH Profi-Universal-Steckschlüssel-Koffer

Metrisch und Zoll, mit 4 Umschaltknarren, Schlag-Steckschlüsseln, Gabelringschlüsseln und Bits für Sicherheitsschrauben.

Coffret de douilles professionnel universel HIGHTECH

métrique et en pouces, avec 4 clés à cliquet réversibles, douilles impact, clés mixtes et embouts pour vis de sécurité.

Valigetta universale di chiavi a bussola HIGHTECH per uso professionale

metrico ed in pollici, con 4 chiavi a cricchetto, chiavi a bussola a macchina, chiavi combinate ed inserti per viti di sicurezza.



HIGHTECH FINE POWER



550 x 380 x 110 mm

- 14 3.5-4-4.5-5-5.5-6-7-8-9
10-11-12-13-14 mm
- 5 1/4"-9/32"-5/16"-11/32"-3/8"
- 8 4-4.5-5-5.5-6-7-8-9 mm
- 5 E4-E5-E6-E7-E8
- 5 M4-M5-M6-M7-M8
- 1/4" 1/4"
- 1/4" 1/4"
- 2 50 mm / 100 mm
- 150 mm
- 110 mm
- 1/4" 1/4"
- Art. 4001

HIGHTECH FINE POWER

- 10 10-11-12-13-14
15-16-17-18-19 mm
- 10 7/16"-1/2"-9/16"-5/8"-11/16"
3/4"-13/16"-7/8"-15/16"-1"
- 6 10-11-12-13-14-15 mm
- 4 14-16-18-21 mm
- 4 E10-E11-E12-E14
- 3/8" 1/4"
- 3/8" 5/16"
- 3/8" 3/8"
- 3/8" 1/4"
- 3/8" 1/2"
- 2 75 mm / 250 mm
- Art. 4011

HIGHTECH FINE POWER

- 6 4-4.5-5.5-6-6.5-8 mm
- 4 PH 1-2-3-4
- 4 PZ 1-2-3-4
- 8 T8-T10-T15-T20-T25-T27-T30-T40
- 8 T8-T10-T15-T20-T25-T27-T30-T40
- 6 3-4-5-6-7-8 mm
- 6 2-2.5-3-4-5-6 mm
- 6 5/64"-3/32"-7/64"-1/8"-9/64"-5/32"
- 3 Nos. 6-8-10
- 4 Nos. 1-2-3-4
- 4 Nos. 4-6-8-10



Art.			
4047	1/4" + 3/8" + 1/2"		1/4" + 5/16"















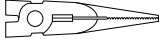



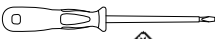

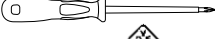
- 15 10-13-15-16-17-18-19-20
21-22-24-27-30-32-34 mm
- 4 17-19-21-22 mm
- 5 E16-E18-E20-E22-E24
- 4 M10-M12-M14-M16
- 1/2" 5/16"
- 1/2" 1/2"
- 1/2" 3/8"
- 2 125 mm / 250 mm
- Art. 4021
- Art. 3006
- 1/4" 1/4"
- 2 10-12 mm
- 5 T45-T50-T55-T60-T70
- 3 10-12-14 mm
- 8 T20-T25-T27-T30-T40-T45-T50-T55
- 70 mm
- 1/4" 1/4"
- 1/4" 1/4"
- 1/4" 3/8"
- 1/4" x 100 mm
- 13 8-9-10-11-12-13-14-15
16-17-18-19-22 mm
- 10 1.5-2-2.5-3-4-5-6-7-8-10 mm
- 200 mm (0-36 mm)
- M22

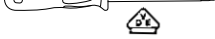
Elektriker-Werkzeugsatz
Jeu d'outils pour électricien
Set di utensili per elettricisti

20
PCS

1000 V

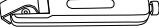

-   180 mm
-   160 mm
-   200 mm
-   160 mm
-   4 0.4 x 2.5 mm - 0.8 x 4.0 mm
1.0 x 5.5 mm - 1.2 x 6.5 mm
-   2 PH 1-2
-   2 T15-T20
-  110-250V
-  140 mm
-  160 mm
-  150 mm
-  140 mm
-  228 mm
-  175 mm



↕ 220 x 300 x 100 mm

Art.	
3996ET	
2990B	ohne Werkzeuge / sans outils / senza utensili



Art. 2990B

Professioneller ABS-Werkzeugkoffer

mit solider Struktur und eloxiertem Aluminiumrahmen mit Kantenstossschutz, Schnappverschlüsse und Zahlenschloss.

Valise rigide professionnelle en ABS

avec structure solide en aluminium avec protection contre les chocs, loquets et serrure à combinaison numérique.

Valigia professionale in ABS

con struttura solida con telaio in alluminio rinforzato, protezioni laterali antiurto, serrature a scatto e chiusura a combinazione.



489 x 193 x 400 mm

1/4" 14 3.5-4-4.5-5-5.5-6-7-8-9
10-11-12-13-14 mm

1/4" 1/4"

1/4" 1/4"

100 mm

45 Art. 3200B

3/8" 12 10-13-14-15-16-17-18
19-20-21-22-24 mm

2 16 mm / 21 mm

3/8" 1/4"

3/8" 3/8"

1/2" 3/8"

150 mm

45 Art. 3210B

1/4" 4 4.5-5.5-6.5-8 mm

4 PH 0-1-2-3

3 PZ 1-2-3

7 T10-T15-T20-T25-T27-T30-T40

7 T10-T15-T20-T25-T27-T30-T40

6 3-4-5-6-7-8 mm

1/4" 1/4"

1/4" 1/4"

Art. 2336 360 g

Art. 2303 300 g



10 1.5-2-2.5-3-4-5
 6-7-8-10 mm Art. 3602

9 T10-T15-T20-T25-T27
T30-T40-T45-T50 Art. 3605







5 Art. 3370 4 x 150 mm
12 x 130 mm
5 x 130 mm
3 x 120 mm
4 x 120 mm

6 Art. 4321 165 mm



Art.		
3995	1/4" + 3/8"	1/4" + 4 mm

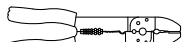

3995.1 Ausführung mit PB Schraubendreher
Modèle avec tournevis PB
PB Modello con giraviti PB



	Art. 3281-180	180 mm
	Art. 3285-200	200 mm
	Art. 3282-160	160 mm
	Art. 2221-250	250 mm
	Art. 3289-160	160 mm
	Art. 2240	150 mm
	Art. 2225	240 mm



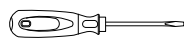
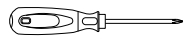
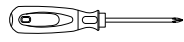
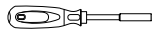

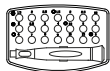

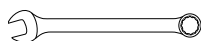
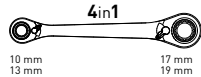
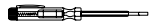

	6	Art. 3312	18 mm
	10x	Art. 3314	18 mm

	5	<ul style="list-style-type: none"> Art. 4110-1 0.5 x 3 mm Art. 4110-2 0.8 x 4 mm Art. 4110-3 0.9 x 5 mm Art. 4110-4 1.1 x 6 mm Art. 4110-5 1.2 x 8 mm
	2	<ul style="list-style-type: none"> Art. 4115-1 No. 1 Art. 4115-2 No. 2
	4	<ul style="list-style-type: none"> Art. 4125-15 T15 Art. 4125-20 T20 Art. 4125-25 T25 Art. 4125-30 T30
		Art. 4128 1/4" x 100mm
		Art. 4701-0519 5 m x 19 mm
		Art. 3180

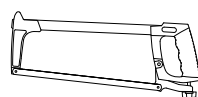
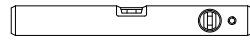

	16	5.5-6-7-8-9-10-11-12-13 14-15-16-17-18-19-22 mm
 <div style="display: flex; justify-content: space-around; font-size: 8px;"> <div>10 mm 13 mm</div> <div>17 mm 19 mm</div> </div>		Art. 3404-1019 10 x 13 mm / 17 x 19 mm
		Art. 2138 110-250 V



	Art. 3305	300 mm
		400 mm
 <div style="display: flex; justify-content: space-around; font-size: 8px;"> <div>320 mm / No. 2</div> </div>	Art. 4320-2	320 mm
	Art. 3574	250 mm / 10"
	Art. 2972C	150 mm / 0 - 6"
	Art. 32065	6 LED (excl. 3x AAA)
	50	



**Universal-Steckschlüssel- und
Werkzeugsatz**

in schlankem, abschliessbarem Aluminium-
Werkzeugkoffer

Jeu de douilles et outils universels

en coffret compact aluminium avec serrure à clé





















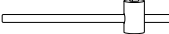

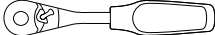







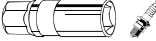









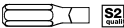









Set di bussole ed utensili universali

in sottile valigia in alluminio chiudibile



1/4" 1/2" 1/4" 109
PCS

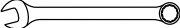

470 x 330 x 90 mm

-   14 3.5-4-4.5-5-5.5-6-7
8-9-10-11-12-13-14 mm
-  5 8-10-11-12-13 mm
-   1/4"  1/4"
-   1/4"  1/4"
-  2 50 mm / 100 mm
-  115 mm
-   Art. 3200B
-   1/4"
-   15 10-13-14-15-16-17-18-19
21-22-24-27-30-32-34 mm
-  4 14-17-18-19 mm
-  **CrMo** 3 17-19-21 mm 
-  2 16 / 21 mm
-   1/2"  1/2"
-  2 125 / 250 mm
-   3/8"  1/2"
-   Art. 3220B
-    6  4-4.5-5.5-6-6.5-8 mm
-  4  PH 0-1-2-3
-  3  PZ 1-2-3
-  6  T10-T15-T20-T25-T30-T40
-  6  T10-T15-T20-T25-T30-T40
-  6  3-4-5-6-7-8 mm
-   1/4"  1/4"
-   1/4"  1/4"
-  9  1.5-2-2.5-3-4-5-6-8-10 mm
-  12 8-10-11-12-13-14-15
16-17-18-19-22 mm







































































Art.		
4055	1/4" + 1/2"	1/4"



Profi-Werkzeugkoffer
Coffret d'outils professionnel
Valigia con utensili professionali

1/4" 1/4" 4 mm CrV

123
PCS

- 1/4"  14  3.5-4-4.5-5-5.5-6-7-8
9-10-11-12-13-14 mm
-  2  1/4"  1/4"
-  2  1/4"  1/4"
-  2  50 mm / 100 mm
110 mm
-  45  Art. 3200B
-  3  1.5-2-2.5 mm
 1/4"  1/4"
-  3 m x 16 mm
-  8 8-10-11-12-13-14-17-19 mm
- 1/4"  4 4.5-5-6.5-8 mm
-  4  PH 0-1-2-3
-  3  PZ 1-2-3
-  7  T10-T15-T20-T25-T27-T30-T40
-  7  T10-T15-T20-T25-T27-T30-T40
-  6  3-4-5-6-7-8 mm
 1/4"  1/4"
-  4 mm  1.5-2-2.5-3-4 mm
-  3  PH000-00-0
-  2  PZ 00-0
-  4  T4-T5-T6-T7
-  4  T8-T9-T10-T15
-  3  1.5-2-2.5 mm
-  1  4.0 x 95 mm
-  Art. 3601 9  1.5-2-2.5-3-4-5-6-8-10 mm \leftrightarrow 397 x 270 x 134 mm
-  Art. 3281-180 180 mm
-  Art. 3282-160 160 mm
-  Art. 3285-200 200 mm
-  Art. 2221-250 250 mm
-  Art. 3310 3 9 mm
-  Art. 3313 10 9 mm
-  Art. 32065 6 LED (excl. 3x AAA)
-  Art. 4110-2 2  4.0 x 100 mm
-  Art. 4110-4 2  6.0 x 150 mm
-  Art. 4115-1 2  PH 1 x 75 mm
-  Art. 4115-2 2  PH 2 x 100 mm
-  Art. 4128  1/4" x 100 mm
-  Art. 2850  1/4"
-  Art. 2138 110-250V
-  Art. 2303 300 g



Art.		
3944	1/4"	1/4" + 4 mm
3944.1	Ausführung mit PB Schraubendreher Modèle avec tournevis PB PB Modello con giraviti PB	
3944.2	Ausführung mit PB Schraubendreher und Hightech-Zangen Modèle avec tournevis et pinces Hightech PB Modello con giraviti PB e pinze Hightech	



Profi-Werkzeugkoffer
Coffret d'outils professionnel
Valigia con utensili professionali

1/4" 3/8" 1/4" 4 mm
CrV **151**
PCS



433 x 323 x 149 mm

- 1/4" 7 3.5-4-4.5-5-5.5-6-7 mm
- 3/8" 16 8-9-10-11-12-13-14-15-16
17-18-19-20-21-22-24 mm
- 2 16 mm / 21 mm
- 3/8" 1/4"
- 3/8" 3/8"
- 2 75 mm / 150 mm
- 3/8" 1/2"
- 3/8" 1/4"
- 45 Art. 3210B
- 1/4" 4 4.5-5-6.5-8 mm
- 4 PH 0-1-2-3
- 3 PZ 1-2-3
- 7 T10-T15-T20-T25-T27-T30-T40
- 7 T10-T15-T20-T25-T27-T30-T40
- 6 3-4-5-6-7-8 mm
- 1/4" 1/4"
- 1/4" 1/4"
- 4 mm 5 1.5-2-2.5-3-4 mm
- 3 PH00-00-0
- 2 PZ 00-0
- 4 T4-T5-T6-T7
- 4 T8-T9-T10-T15
- 3 1.5-2-2.5 mm
- Art. 1789
- 25 mm
- Art. 3180
- 27 mm
- Art. 2410
- 250 mm / 10"
- 3 1.5-2-2.5 mm
- 10 1.5-2-2.5-3-4
- 5-6-7-8-10 mm
- Art. 3602
- 180 mm
- Art. 3281-180
- 160 mm
- Art. 3282-160
- 200 mm
- Art. 3285-200
- 250 mm
- Art. 2221-250
- 150 mm
- Art. 2240
- 300 g
- Art. 2303
- 4 x 150 mm
- 12 x 130 mm
- 5 x 130 mm
- 3 x 120 mm
- 4 x 120 mm
- Art. 3370
- 5
- 300 mm
- Art. 3305

- 3 300 mm / 24t
- Art. 3312 6 18 mm
- Art. 3314 10 18 mm
- Art. 4320-2
- 250 mm / No. 2
- 175 mm
- 150 mm / 0-6" digital
- 3 m x 16 mm
- Art. 32065 6 LED (excl. 3x AAA)
- Art. 4110-2 2 4.0 x 100 mm
- Art. 4110-4 2 6.0 x 150 mm
- Art. 4115-1 2 PH 1 x 75 mm
- Art. 4115-2 2 PH 2 x 100 mm
- Art. 4128 1/4" x 100 mm
- Art. 2138 110-250V



Art.		
3946	1/4" + 3/8"	1/4" + 4 mm
3946.1	Ausführung mit PB Schraubendreher Modèle avec tournevis PB Modello con giraviti PB	
3946.2	Ausführung mit PB Schraubendreher und Hightech-Zangen Modèle avec tournevis et pinces Hightech PB Modello con giraviti PB e pinze Hightech	



Profi-Werkzeugkoffer
Coffret d'outils professionnel
Valigia con utensili professionali



- 14 3.5-4-4.5-5-5.5-6-7
8-9-10-11-12-13-14 mm
- 1/4" 1/4"
- 1/4" 1/4"
- 2 50 mm / 100 mm
- 1/4" 1/4"
- 45 Art. 3200B
- 14 10-13-15-16-17-18-19
20-21-22-24-27-30-32 mm
- 1/2" 1/2"
- 250 mm
- 3/8" 1/2"
- 45 Art. 3220B
- 4 4.5-5-6.5-8 mm
- 4 PH 0-1-2-3
- 3 PZ 1-2-3
- 7 T10-T15-T20-T25-T27-T30-T40
- 7 T10-T15-T20-T25-T27-T30-T40
- 6 3-4-5-6-7-8 mm
- Art. 1789
- 25 mm
- Art. 2410
- 9 8-10-11-12-13-14-17-19-22 mm
- 250 mm / 10"
- Art. 2410
- 10 1.5-2-2.5-3-4-5-6-7-8-10 mm
- 9 T10-T15-T20-T25-T27
T30-T40-T45-T50
- Art. 4110-2 0.8 x 4.0 mm
- Art. 4110-3 3 0.9 x 5.0 mm
- Art. 4110-4 1.1 x 6.0 mm
- Art. 4115-1 2 PH 1-2
- Art. 4115-2
- Art. 4125-15 4 T15-T20-T25-T30
- Art. 4125-20
- Art. 4125-25
- Art. 4125-30
- Art. 4128 1/4" 1/4"
- Art. 2138 110-250V
- Art. 3281-180 180 mm
- Art. 3282-160 160 mm
- Art. 3180



489 x 365 x 178 mm

- Art. 3285-200 200 mm
- Art. 2221-250 250 mm
- Art. 2216-200 200 mm
- Art. 2225 240 mm
- Art. 2240 150 mm
- Art. 2303 300 g
- Art. 3370 5
- 4 x 150 mm
- 12 x 130 mm
- 5 x 130 mm
- 3 x 120 mm
- 4 x 120 mm
- Art. 3305 300 mm
- 3 300 mm / 24Z
- Art. 3310 9 mm
- Art. 3313 10 9 mm
- Art. 3312 18 mm
- Art. 3314 10 18 mm
- Art. 4320-2 320 mm / No. 2
- 6 160 mm
- Art. 3197 2000 g
- 175 mm
- Art. 32065 6 LED (excl. 3x AAA)
- 150 mm
- 0-6" / digital
- 5 m x 19 mm
- 20 200 mm



Art.		
3948	1/4" + 1/2"	1/4" + 4 mm
3948.1	Ausführung mit PB Schraubendreher Modèle avec tournevis PB Modello con giraviti PB	
3948.2	Ausführung mit PB Schraubendreher und Hightech-Zangen Modèle avec tournevis et pinces Hightech PB Modello con giraviti PB e pinze Hightech	



Profi-Werkzeugkoffer mit BOSCH Akku-Schrauber

mit Kantenschutz. Die Werkzeuge sind in einer speziell hochverdichteten Weich-Schaumstoff-Einlage (EVA) mit einer dauerhaften und leicht zu reinigenden Hartplastik-Oberfläche passgenau verstaut bzw. sicher durch Taschen und Bänder auf der Werkzeugtafel und im Koffer-Deckel gesichert.

Coffret d'outils professionnels en aluminium avec perceuse/visseuse sans fil BOSCH

avec protections d'angles. Les outils sont rangés dans des inserts souples en mousse de haute densité (EVA), avec revêtement renforcé en PVC durable et facile à nettoyer, ou ils sont saignés solidement et insérés dans des compartiments sur des panneaux porte-outils.

Valigia con utensili professionali con trapano/avvitatore senza fili BOSCH

con protezione laterale antiurto. Gli utensili sono riposti in esclusivi vassoi realizzati in materiale espanso ad alta densità (EVA) con superficie laminata che garantisce una maggior durata e una pulizia più facile, nelle apposite tasche o con elastici su pannelli porta utensili e nel coperchio.



489 x 365 x 178 mm



- 14 3.5-4-4.5-5-5.5-6-7-8-9 10-11-12-13-14 mm
- 1/4" 1/4" 1/4"
- 1/4" 1/4"
- 1/4" 1/4"
- 100 mm
- 45 Art. 3200B
- 1/4" 1/4"
- 12 15-16-17-18-19-20 21-22-24-27-30-32 mm
- 1/2" 1/2" 1/2"
- 3/8" 1/2"
- 250 mm

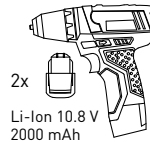
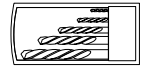
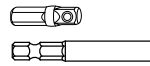
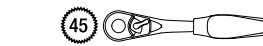

2x Li-Ion 10.8 V 2000 mAh

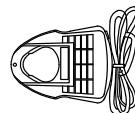

Art. 3220B













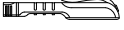

- 4 4.5-5.5-6.5-8 mm
- 4 PH 0-1-2-3
- 3 PZ 1-2-3
- 7 T10-T15-T20-T25-T27-T30-T40
- 7 T10-T15-T20-T25-T27-T30-T40
- 6 3-4-5-6-7-8 mm
- 1/4" 1/4"
- 1/4" 1/4"
- 19 Ø 1-10 mm / 0.5 mm HSS-G / DIN 338 N

BOSCH
GSR 10,8-2-LI Professional









1 60-min

Art.	1/4" + 1/2"	1/4" + 4 mm
3949		
3949.1	Ausführung mit PB Schraubendreher Modèle avec tournevis PB Modello con giraviti PB	
3949.2	Ausführung mit PB Schraubendreher und Hightech-Zangen Modèle avec tournevis et pinces Hightech PB Modello con giraviti PB e pinze Hightech	



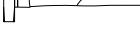









		8	8-10-11-12-13-14-17-19 mm
	Art. 3602	10	1.5-2-2.5-3-4-5-6-7-8-10 mm
	Art. 3605	9	T10-T15-T20-T25-T27 T30-T40-T45-T50
	Art. 4320-2		320 mm / No. 2
		6	165 mm
	Art. 2138		110-250V
	Art. 3196		2000 g
	Art. 32065		6 LED (excl. 3x AAA)
	Art. 4701-0519		5 m x 19 mm
		5	1.5-2-2.5-3-4 mm
		3	PH000-00-0
		2	PZ 00-0
		4	T4-T5-T6-T7
	Art. 3180	4	T8-T9-T10-T15
		3	1.5-2-2.5 mm
		1	4.0 x 95 mm

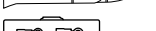
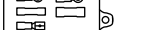
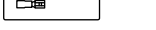

	Art. 2410		250 mm / 10"
	Art. 3305		300 mm
	Art. 3316-24	3	300 mm / 24Z
	Art. 3970		228 mm
	Art. 2303		300 g
	Art. 3370	5	4 x 150 mm 12 x 130 mm 5 x 130 mm 3 x 120 mm 4 x 120 mm
	Art. 3312		18 mm
	Art. 3314	10	18 mm
		20	

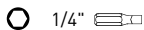

	Art. 2240		150 mm
	Art. 3281-180		180 mm
	Art. 3282-160		160 mm
	Art. 3285-200		200 mm
	Art. 2225		240 mm
		50	
	Art. 2221-250		250 mm
	Art. 4110-2		0.8 x 4.0 mm
	Art. 4110-3	3	0.9 x 5.0 mm
	Art. 4110-4		1.1 x 6.0 mm
	Art. 4115-1	2	PH 1-2
	Art. 4115-2		
	Art. 4128		1/4" 



HIGHTECH FINE POWER Werkzeugkoffer

mit einer 120 Feinzahn-Umschaltknarre in einem kompakten und schlanken PU-Koffer in Karbon-Design, mit eloxiertem Aluminiumrahmen und Schnappverschlüssen.

HIGHTECH FINE POWER coffret d'outils

avec un cliquet 120 dents à tête fine dans un coffret PU effet carbone avec cadre en aluminium anodisé et fermetures métalliques à ressort

HIGHTECH FINE POWER valigia di utensili









con cricchetto a 120 denti a testa fine in valigia in PU effetto carbonio con telaio in alluminio anodizzato e chiusure metalliche.



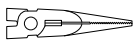

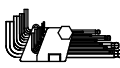
HIGHTECH FINE POWER

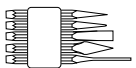

↕ 485 x 350 x 120 mm

-  Art. 3282-160 160 mm
-  Art. 3281-180 180 mm
-  Art. 3285-200 200 mm
-  Art. 2221-250 250 mm
-  Art. 3602 10  1.5-2-2.5-3-4-5-6-7-8-10 mm
-  Art. 3370 5
4 x 150 mm
12 x 130 mm
5 x 130 mm
3 x 120 mm
4 x 120 mm
-  Art. 3312 18 mm
-  Art. 3314 10 18 mm



Art.		
4015	1/4" + 3/8"	1/4" + 4 mm
4015.1	Ausführung mit PB Schraubendreher Modèle avec tournevis PB Modello con giraviti PB	



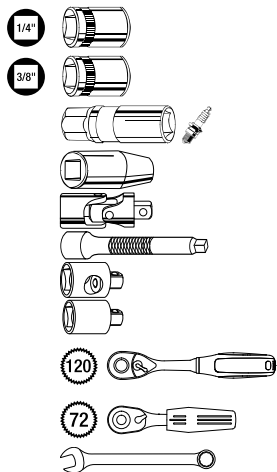

- 7 ○ 3.5-4-4.5-5-5.5-6-7 mm
- 16 ○ 8-9-10-11-12-13-14-15-16
17-18-19-20-21-22-24 mm
- 2 ○ 16 mm / 21 mm
- 3/8" ○ 1/4"
- 3/8" ■ 3/8"
- 2 75 mm / 150 mm
- 1/2" ■ 3/8"
- 3/8" ■ 1/4"
- Art. 3210

HIGHTECH FINE POWER
Art. 3799

- 8 8-10-11-12-13-14-17-19 mm
- Art. 32065 6 LED (excl. 3x AAA)

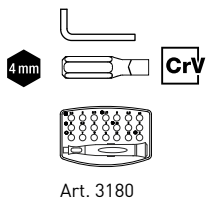

- 3 ● 1.5-2-2.5 mm
- 5 — 1.5-2-2.5-3-4 mm
- 3 + PH000-00-0
- 2 + PZ 00-0
- 4 * T4-T5-T6-T7
- 4 * T8-T9-T10-T15
- 3 ● 1.5-2-2.5 mm
- 4.0 x 95 mm
- 6 — 4-4.5-5.5-6-6.5-8 mm
- 4 + PH 1-2-3-4
- 4 + PZ 1-2-3-4
- 8 * T8-T10-T15-T20-T25-T27-T30-T40
- 8 * T8-T10-T15-T20-T25-T27-T30-T40
- 6 ● 3-4-5-6-7-8 mm
- 6 ● 2-2.5-3-4-5-6 mm
- 6 ● 5/64"-3/32"-7/64"-1/8"-9/64"-5/32"
- 4 ● Nos. 4-6-8-10
- 4 ▲ Nos. 1-2-3-4
- 3 + Nos. 6-8-10

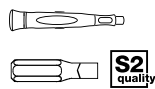

- Art. 4110-2 2 — 4.0 x 100 mm
- Art. 4110-4 2 — 6.0 x 150 mm
- Art. 4115-1 2 + PH1 x 75 mm
- Art. 4115-2 2 + PH2 x 100 mm
- Art. 4128 ○ 1/4" x 100
- Art. 2138 110-250V
- Art. 47123 200 mm (0-36 mm)
- M22
- Art. 2303 300 g
- Art. 2240 150 mm
- Art. 3196 130 - 630 mm 2 kg
- 175 mm
- Art. 4701-0316 3 m x 16 mm



Universal-Werkzeugsatz

in 5-teiliger, solider Metall-Werkzeugkiste, abschliessbar mit Hangschloss. Mit dem ordentlichen PVC Einlegesystem ist der Platz jedes Werkzeuges schnell gefunden. Werkzeug-Zusammenstellung auf die Anforderungen von Auszubildenden abgestimmt. Abmessungen speziell angepasst für den Garderobenschrank! Leerschale für die individuelle Nutzung.

Jeu d'outils universels

dans caisse métallique très résistante avec 5 compartiments, verrouillable avec un cadenas. Modules PVC moulés à la forme de chaque outil pour identifier rapidement l'emplacement. Composition spéciale conforme aux listes des lycées professionnels. Des dimensions spécialement adaptées aux armoires vestiaires! Module vide et espace disponible pour l'utilisateur.

Set di utensili universali

in solida valigetta in metallo a 5 scomparti, chiusura lucchettabile. Grazie al sistema ordine vaschetta in PVC ogni attrezzo ha il suo posto. Utensili selezionati con cura per l'uso scolastico. Le dimensioni sono state adattate apposta per armadi spogliatoio! Vaschetta vuota per uso individuale.

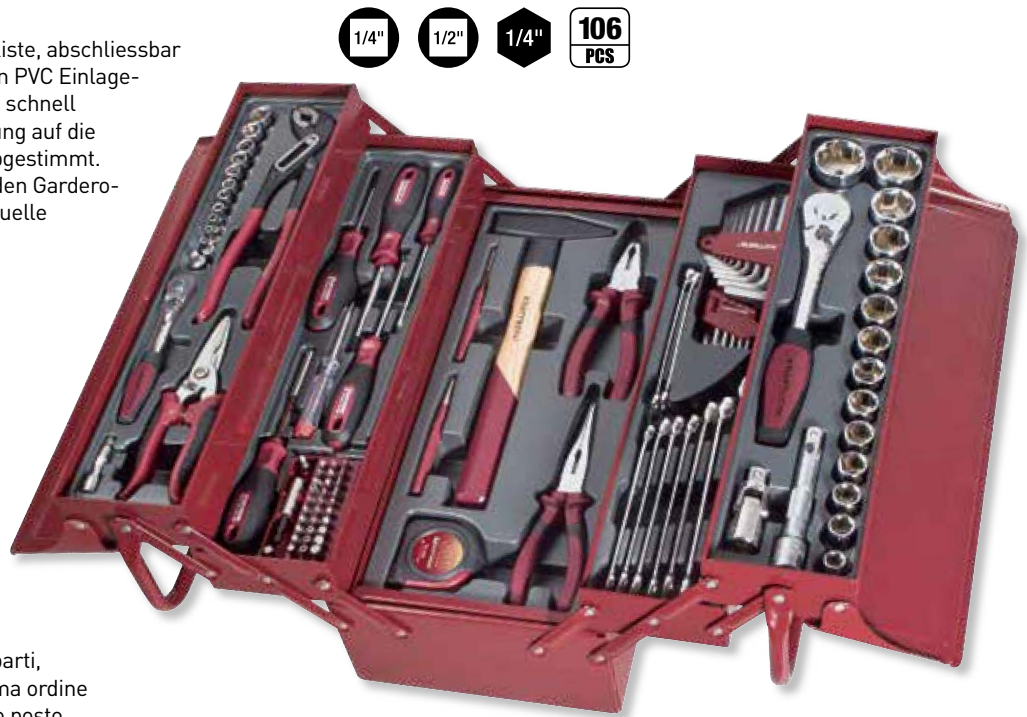

1/4" 1/2" 1/4" 106 PCS

485 x 260 x 240 mm

		11	3.5-4-5-6-7-8-9 10-11-12-13 mm
			50 mm
			1/4" 1/4"
			Art. 3200B
		14	10-13-14-15-16-17-18 19-21-22-24-27-30-32 mm
			125 mm
			1/2" 1/2"
			Art. 3220B
		4	4.5-5.5-6.5-8 mm
		4	PH 0-1-2-3
		3	PZ 1-2-3
		7	T10-T15-T20-T25-T27-T30-T40
		7	T10-T15-T20-T25-T27-T30-T40
		6	3-4-5-6-7-8 mm
			1/4" 1/4"
			1/4" 1/4"
		10	8-9-10-11-12-13-14-15-17-19 mm
		9	T10-T15-T20-T25-T27-T30-T40-T45-T50

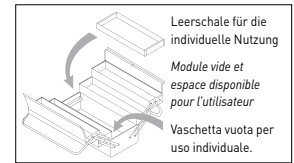

	Art. 3601	9	1.5-2-2.5-3-4-5-6-8-10 mm
	Art. 4110-2 Art. 4110-3	2	0.4 x 2.5 mm - 0.9 x 5 mm
	Art. 4115-1 Art. 4115-2	2	PH 1-2
	Art. 4128		1/4"
	Art. 2138		110-250V
	Art. 3281-180		180 mm
	Art. 328-200		200 mm
	Art. 2221-251C		250 mm
	Art. 2240		150 mm
	Art. 2303		300 g
	Art. 1350-3		3 mm
	Art. 1358-2		No. 2
	Art. 4701-0316		3 m x 16 mm

Art.	1/4"	1/2"
3036	1/4" + 1/2"	1/4"

ABS-Profi-Werkzeugkoffer

mit 2 Werkzeugtafeln, solidem, eloxiertem Aluminiumrahmen mit Stosskantenschutz, Schnappverschlüsse und Zahlenschloss.

Valise d'outils en ABS rigide

avec 2 panneaux porte-outils, châssis solide en aluminium avec protection contre les chocs, loquets et serrure numérique.

Valigia professionale in ABS

a 2 scomparti portautensili, in solido telaio in alluminio rinforzato, con protezione laterale antiurto, serrature a scatto e chiusura a combinazione.

Art.	♁
2998	5.2 kg



↕ 486 x 373 x 190 mm
ausssen / extérieur / esterno

ABS

Profi-ABS-Roll-Koffer

mit solidem, eloxiertem Aluminiumrahmen mit Stosskantenschutz, abschliessbaren Kippschlössern auf 2 Inline-Rollen und ausziehbarem Handgriff.

Valise d'outils roulante en ABS

avec un châssis solide en aluminium, des coins renforcés contre les chocs, équipée de 2 roulettes, 2 serrures et une poignée télescopique.

Valigia "trolley" portautensili professionale in ABS

in solido telaio in alluminio rinforzato, con protezione laterale antiurto, serrature a scatto e chiusura a combinazione. Ruote in gomma ed impugnatura estensibile.

Art.	♁
2995	6.7 kg



↕ 490 x 410 x 265 mm
ausssen / extérieur / esterno

ABS

Werkzeugkiste

aus dickem Stahlblech, 5 Werkzeugfächer.
Europäisches Qualitäts-Produkt.

Caisse à outils

en tôle d'acier épais, à 5 compartiments.
Produit de qualité Européen.

Cassetta metallica

in lamiera d'acciaio resistente, a 5 scomparti.
Qualità europea.



Art.	↕	⚖
3952	430 x 200 x 200 mm	5.8 kg
3950	530 x 200 x 200 mm	6.5 kg

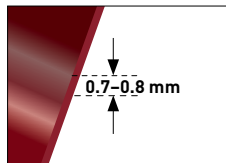

Inox-Werkzeugkiste

Boîte à outils en acier inoxydable

Box attrezzi acciaio inossidabile

inox



Art.	↕
3953	400 x 230 x 200 mm
3954	420 x 250 x 200 mm



Werkzeugtaschen

- aus robustem und wasserundurchlässigem 600 Denier Polyester
- 12 äussere und 8 innere Taschen für mehr Stauraum
- mit Reissverschluss
- mit Handgriff und gepolstertem Trageriemen

Sacoche à outils

- Fabrication robuste en tissu polyester imperméable de 600 Deniers
- 12 poches extérieures + 8 intérieures pour une grande capacité de rangement
- Fermeture zippée
- Poignée et bandoulière rembourrées

Borsa per attrezzi

- Fabbricazione robusta in tessuto poliestere impermeabile 600 Deniers
- 12 tasche esterne e 8 interne per una grande capacità di stivaggio
- Con chiusura lampo
- Con maniglia e tracolla imbottita

Art.	↕	⚖	L
3955	400 x 220 x 350 mm	15 kg	24
3956	510 x 360 x 400 mm	20 kg	42



Trolley-Werkzeug-Rucksack

- aus robustem und wasserundurchlässigem 600 Denier Polyester
- mit Teleskop-Gummihandgriff
- mit 3 unterschiedlich grosse Fächer, Seitentaschen und Laptop-Extrafach

Sac à dos trolley pour outils

- Fabrication robuste en tissu polyester imperméable de 600 Deniers
- Poignée télescopique en caoutchouc
- 3 compartiments, poches latérales et emplacement pour ordinateur portable

Borsa per attrezzi trolley

- Fabbricazione robusta in tessuto poliestere impermeabile 600 Deniers
- Con manico telescopico in gomma
- Con 3 compartimenti, tasche laterali e vano per portatile

Art.	↕	max. ⚖	L
3957	350 x 200 x 550 mm	20 kg	20



Werkzeugtaschen mit Bügel

- aus robustem und wasserundurchlässigem 1680 Denier Polyester
- stabiler Handgriff aus Edelstahl mit ergonomischer Polsterung
- mit extra verstärkten Seiten
- Abdeckung mit Reissverschluss
- zahlreiche Innentaschen
- solider Kunststoff Boden aus PVC
- mit gepolstertem Trageriemen

Sacoche à outils avec sangle

- Fabrication robuste en tissu polyester imperméable de 1680 Deniers
- Poignée solide en acier inoxydable avec rembourrage ergonomique
- Renforts latéraux
- Fermeture zippée sur le dessus
- Nombreuses poches intérieures
- Fond en PVC solide
- Avec sangle rembourrée

Borsa per attrezzi con maniglia in metallo

- Fabbricazione robusta in tessuto poliestere impermeabile 600 Deniers
- Maniglia in solido acciaio inossidabile con imbottitura ergonomica.
- Con rinforzi laterali
- Copertura con chiusura lampo
- Numerose tasche interne
- Fondo in solido PVC
- Con tracolla imbottita

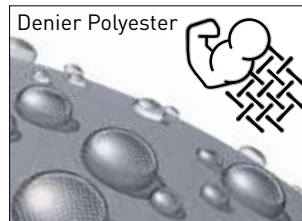

Denier Polyester



Viel Stauraum
Grande capacité de rangement
Grande capacità di stivaggio



Solider Handgriff aus Edelstahl
Poignée solide en acier inoxydable
Maniglia in solido acciaio inossidabile



Solider PVC-Boden
Bandoulière détachable
Fondo in solido PVC



Gepolsteter Trageriemen, abnehmbar
Bandoulière rembourrée, détachable
Tracolla imbottita, staccabile

Werkzeugtasche mit Bügel

Sacoche à outils avec sangle

Borsa per attrezzi con maniglia in metallo

Art.	↕	max. ΔΔ	L
3958	390 x 210 x 300 mm	18 kg	10



Werkzeugtasche mit Bügel

Sacoche à outils avec sangle

Borsa per attrezzi con maniglia in metallo

Art.	↕	max. ΔΔ	L
3959	440 x 260 x 370 mm	23 kg	40



Werkzeugtaschen mit Werkzeugen
Sacoches avec outils
Borse con attrezzi

Art.	±	max. ⚖️	L
3955-30	400 x 220 x 350 mm	15 kg	24
3956-30	510 x 360 x 400 mm	20 kg	42
3957-30	350 x 200 x 550 mm	20 kg	20
3958-30	390 x 210 x 300 mm	18 kg	10
3959-30	440 x 260 x 370 mm	23 kg	40



10 8-9-10-11-12-13-14-15-17-19 mm



10 T10-T15-T20-T25-T27
T30-T40-T45-T50

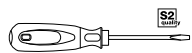

3 0.6 x 3 mm
0.8 x 4 mm
1.0 x 5 mm



2 PH 1-2



180 mm

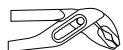

250 mm



300 g



3 m x 19 mm

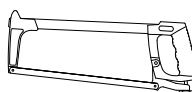

300 mm

Magnetische Aluminium-Stecknusschienen

- Leicht und kompakt
- Magnetisch, kein Verschrauben
- Korrosionsbeständig
- Es können individuelle Sätze zusammenstellt werden
- Klammern/Nüsse 1/4", 3/8", 1/2" auf der gleichen Schiene kombinierbar

Rails magnétiques aluminium pour douilles

- Légers et compacts
- Magnétiques, adhérents sans vis sur tout support métallique (servante, colonne de pont, etc...)
- Résistant contre la corrosion
- Possibilité de composer des jeux personnalisés
- Possibilité de combiner des clips/douilles 1/4", 3/8", 1/2" sur le même rail

Binario porta bussola in alluminio magnetizzato

- Leggero e compatto
- Magnetico non necessita di viti
- Resistente alla corrosione
- Possibilità di combinare a scelta l'assortimento di bussole
- Possibilità di abbinare sullo stesso supporto diverse tipologie di clip da 1/4", 3/8", 1/2"

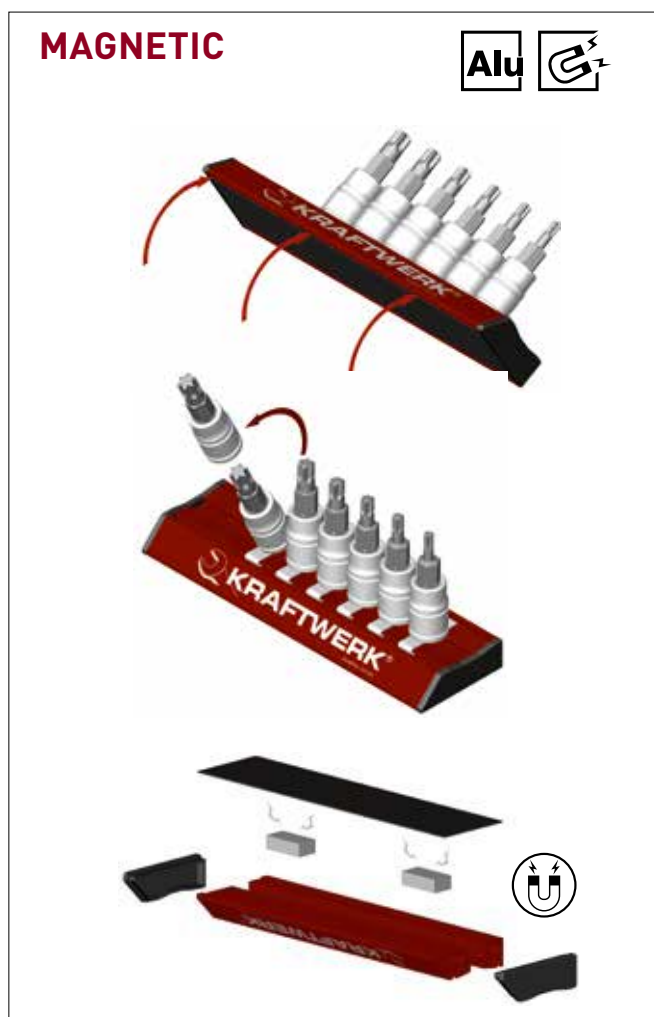

COMBI-Steckschlüssel-Satz Jeu de douilles COMBI multi-empreinte Set di chiavi a bussola COMBI

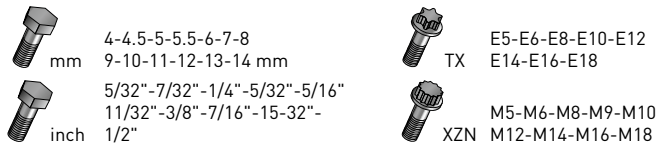

Art.	Ø	L mm
130990	1/4"	25



Steckschlüssel-Satz Zollmasse Jeu de douilles en pouce Set di chiavi a bussola in pollici

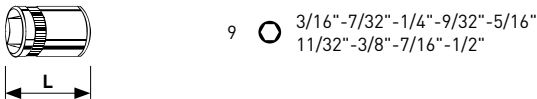

Art.	Ø	L mm
100599	1/4"	25



Steckschlüssel-Satz lang Jeu de douilles longues Set di chiavi a bussola lunghe

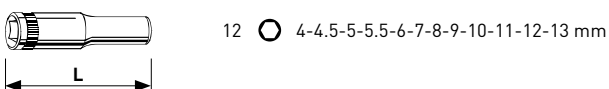

Art.	Ø	L mm
101990	1/4"	50

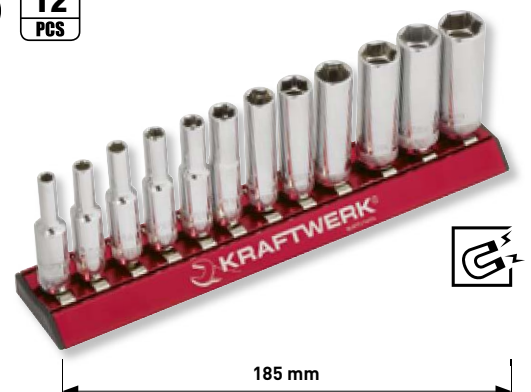

Steckschlüssel-Satz lang, Zollmasse
Jeu de douilles longues en pouce
Set di chiavi a bussola lunghe in pollici

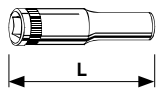

9 ○ 3/16"-7/32"-1/4"-9/32"-5/16"
11/32"-3/8"-7/16"-1/2"

Art.	○	L mm
101599	1/4"	50



Aussen-TX-Steckschlüssel-Satz
Jeu de douilles TX
Set di chiavi a bussola TX esterno

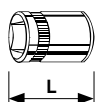

7 ☼ E4-E5-E6-E7-E8-E10-E11

Art.	○	L mm
120099	1/4"	25



TX-Bit-Steckschlüssel-Satz
Jeu de douilles-embouts TX
Set di chiavi a bussola con inserto TX

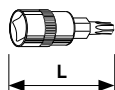

8 ☼ T8-T10-T15-T20-T25-T27-T30-T40

Art.	○	L mm
105099	1/4"	38



5-Stern-TX-Bit-Steckschlüssel-Satz
Jeu de douilles-embouts TX 5 pans
Set di chiavi a bussola con inserto TX a stella 5 punte

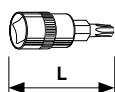

9 ☼ TS8-TS9-TS10-TS15-TS20
TS25-TS27-TS30-TS40

Art.	○	L mm
115099	1/4"	38



5-Stern-Loch-TX-Bit-Steckschlüssel-Satz
Jeu de douilles-embouts TX 5 pans creux
Set di chiavi a bussola TX a stella 5 punte con foro

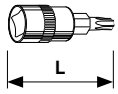

9 TS8-TS9-TS10-TS15-TS20
 TS25-TS27-TS30-TS40

Art.		L mm
115399	1/4"	38

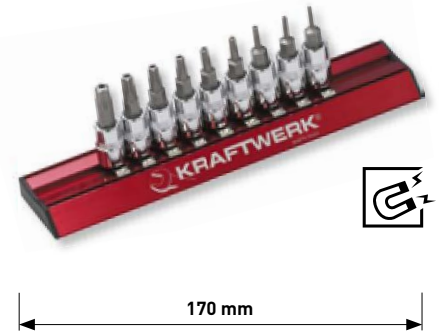

Inbus-Bit-Steckschlüssel-Satz
Jeu de douilles-embouts hexagonales
Set di chiavi a bussola con inserto esagonale

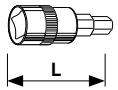

6 3-4-5-6-7-8 mm

Art.		L mm
106099	1/4"	38

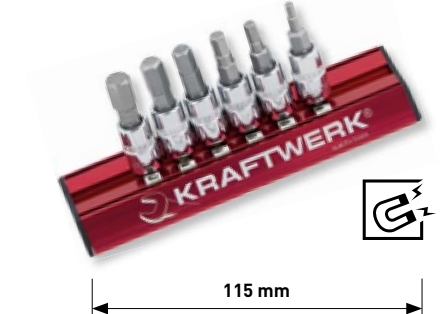

Inbus-Bit-Steckschlüssel-Satz Zollmasse
Jeu de douilles-embouts hexagonales en Pouce
Set di chiavi a bussola con inserto esagonale in pollici

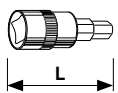

5 1/8"-5/32"-3/16"-7/32"-1/4"

Art.		L mm
106599	1/4"	38

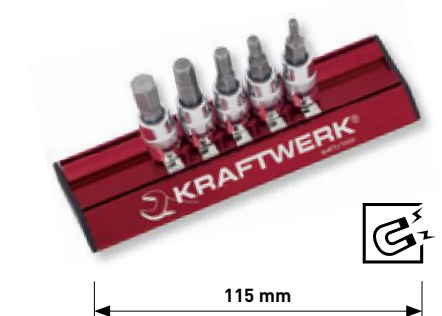

Steckschlüssel-Satz Zollmasse
Jeu de douilles en pouce
Set di chiavi a bussola in pollici

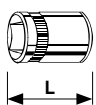

12 5/16"-3/8"-7/16"-1/2"-9/16"-5/8"
 11/16"-3/4"-13/16"-7/8"-15/16"-1"

Art.		L mm
200599	3/8"	25



Steckschlüssel-Satz lang
Jeu de douilles longues
Set di chiavi a bussola lunghe

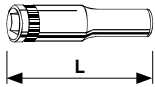

11 ○ 8-10-11-12-13-14-15-17-18-19-22 mm

Art.	○	L mm
201990	3/8"	64

Zündkerzen-Steckschlüssel-Satz
Jeu de douilles pour bougies
Set di chiavi a bussola per candele

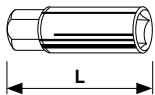

3 ○ 16-18-21 mm

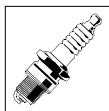

Art.	○	L mm
201998	3/8"	64-65-70

Steckschlüssel-Satz lang, Zollmasse
Jeu de douilles longues en pouce
Set di chiavi a bussola lunghe in pollici

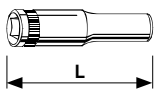

7 ○ 3/8"-7/16"-1/2"-9/16"-11/16"-3/4"-7/8"

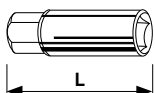

2 ○ 5/8"-13/16"

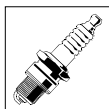

Art.	○	L mm
201599	3/8"	64

Aussen-TX-Steckschlüssel-Satz
Jeu de douilles TX
Set di chiavi a bussola TX esterno

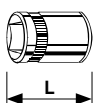

12 ☼ E4-E5-E6-E7-E8-E10-E11
E12-E14-E16-E18-E20

Art.	○	L mm
220099	3/8"	28

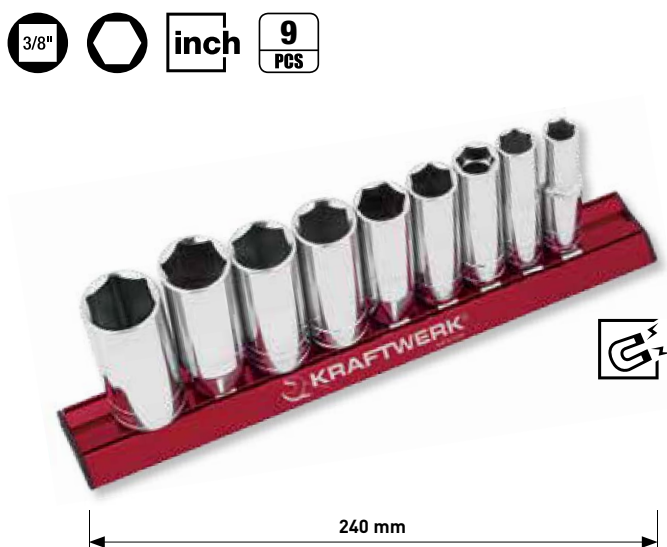
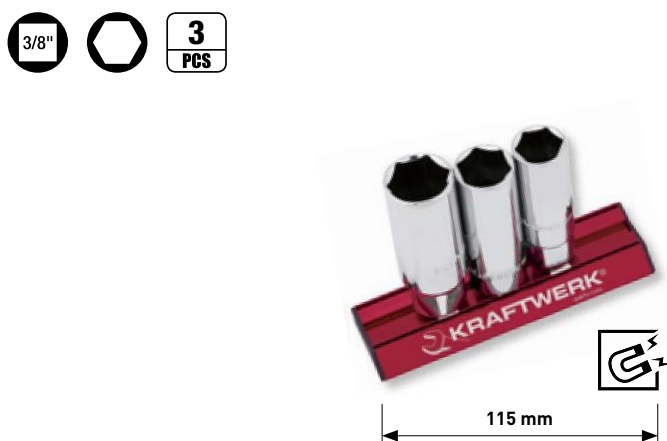

TX-Bit-Steckschlüssel-Satz
Jeu de douilles-embouts TX
Set di chiavi a bussola con inserto TX

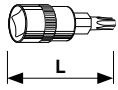

11 T10-T15-T20-T25-T27-T30
T40-T45-T50-T55-T60

Art.		L mm
205099	3/8"	48

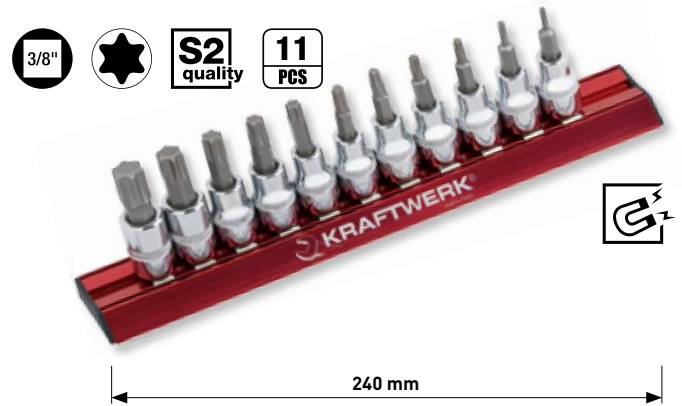

Loch-TX-Bit-Steckschlüssel-Satz
Jeu de douilles-embouts TX creux
Set di chiavi a bussola con inserto TX con foro

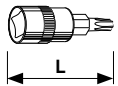

11 T10-T15-T20-T25-T27-T30
T40-T45-T50-T55-T60

Art.		L mm
205399	3/8"	48



Inbus-Bit-Steckschlüssel-Satz
Jeu de douilles-embouts hexagonales
Set di chiavi a bussola con inserto esagonale

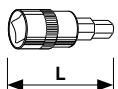

7 3-4-5-6-7-8-10 mm

Art.		L mm
206099	3/8"	48



Inbus-Bit-Steckschlüssel-Satz Zollmasse
Jeu de douilles-embouts hexagonales en Pouce
Set di chiavi a bussola con inserto esagonale in pollici

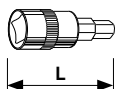



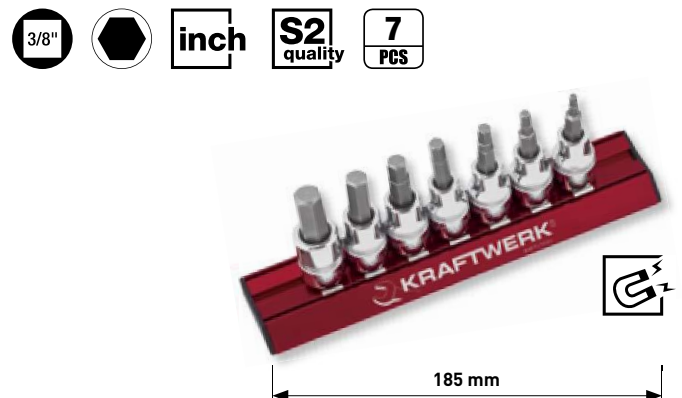

7 1/8"-5/32"-3/16"-7/32"-1/4"-5/16"-3/8"

Art.		L mm
206599	3/8"	48



COMBI-Steckschlüssel-Satz
Jeu de douilles COMBI multi empreinte
Set di chiavi a bussola COMBI

1/2"  **10**
PCS



- | | | | | |
|---|--------------------------------|-------------------|---|--------------------------------|
|  | 10-11-12-13-14
mm | 15-16-17-18-19 mm |  | E12-E14-E16-E18
E20-E22-E24 |
|  | 3/8"-7/16"-15/32"-1/2"
inch | 19/32"-5/8"-3/4" |  | XZN M12-M14-M16-M18 |



Art.		L mm
330990	1/2"	38

COMBI-Steckschlüssel-Satz
Jeu de douilles COMBI multi empreinte
Set di chiavi a bussola COMBI

1/2"  **7**
PCS

- | | | | |
|---|-----------------------------------|---|----------------------------|
|  | 20-21-22-24-27-30-32 mm |  | E26-E28-E30-E34
E38-E40 |
|  | 25/32"-13/16"-7/8"-15/16"
inch | 1-1/16"-1-3/16"-1-1/4" | |



Art.		L mm
330991	1/2"	42

Steckschlüssel-Satz lang
Jeu de douilles longues
Set di chiavi a bussola lunghe

1/2"  **11**
PCS

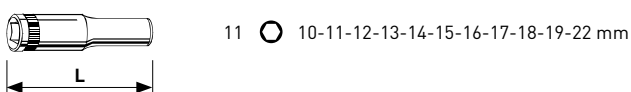

Art.		L mm
301990	1/2"	77

Zündkerzen-Steckschlüssel-Satz
Jeu de douilles pour bougies
Set di chiavi a bussola per candele

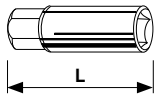

2 ○ 16-21 mm

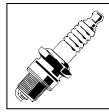

Art.	○	L mm
301998	1/2"	64-70



Schlag-Steckschlüssel-Satz lang
Jeu de douilles longues impact
Set di chiavi a bussola lunghe a macchina



3 ○ 17-19-21 mm

Art.	○	L mm
381099	1/2"	85



Aussen-TX-Steckschlüssel-Satz
Jeu de douilles TX
Set di chiavi a bussola TX esterno

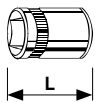

8 ☆ E10-E12-E14-E16-E18-E20-E22-E24

Art.	○	L mm
320099	1/2"	40



TX-Bit-Steckschlüssel-Satz
Jeu de douilles-embouts TX
Set di chiavi a bussola con inserto TX

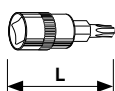

12 ☆ T10-T15-T20-T25-T27-T30
T40-T45-T50-T55-T60-T70

Art.	○	L mm
325099	1/2"	56



TX-Bit-Steckschlüssel-Satz
Jeu de douilles-embouts TX
Set di chiavi a bussola con inserto TX

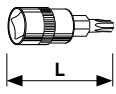

1/4" 7
1/2" 6



T8-T10-T15-T20-T25-T27-T30
T40-T45-T50-T55-T60-T70

Art.	Ø	L mm
99045	1/4" 1/2"	37 56

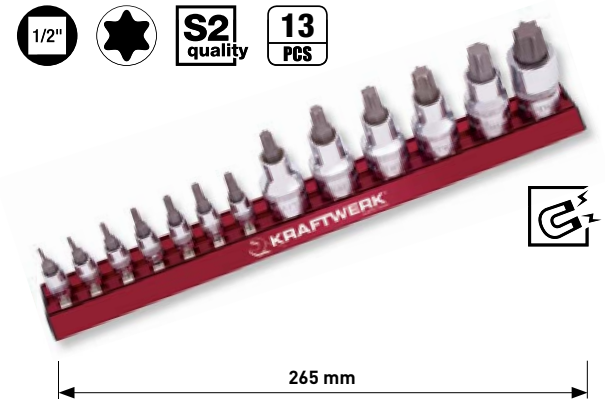

TX-Lang-Bit-Steckschlüssel-Satz
Jeu de douilles-embouts longues TX
Set di chiavi a bussola con inserto TX lunghe

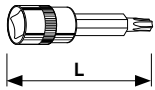

10



T10-T15-T20-T25-T27
T30-T40-T45-T50-T55

Art.	Ø	L mm
335099	1/2"	100

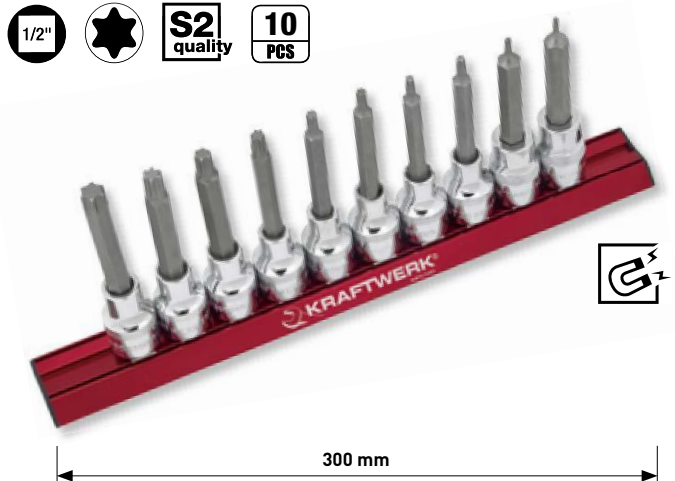

Inbus-Bit-Steckschlüssel-Satz
Jeu de douilles-embouts hexagonales
Set di chiavi a bussola con inserto esagonale

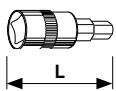

8



5-6-7-8-10-12-14-17 mm

Art.	Ø	L mm
326099	1/2"	56



Inbus-Bit-Steckschlüssel-Satz
Jeu de douilles-embouts hexagonales
Set di chiavi a bussola con inserto esagonale

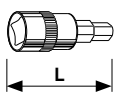

1/4" 5
1/2" 5



3-4-5-6-7 mm
8-10-12-14-17 mm

Art.	Ø	L mm
99046	1/4" 1/2"	37 56

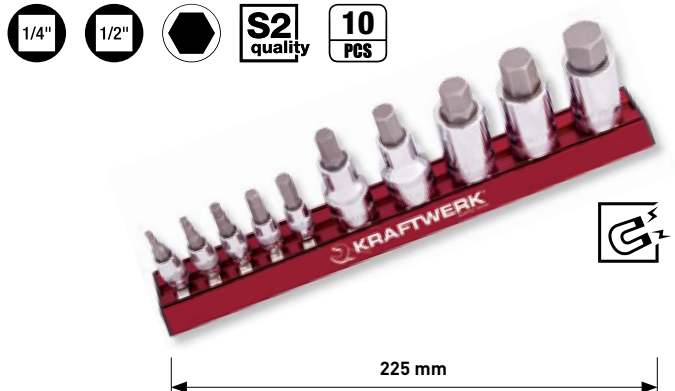

Inbus-Lang-Bit-Steckschlüssel-Satz
Jeu de douilles-embouts longues hexagonales
 Set di chiavi a bussola con inserto esagonale lunghe

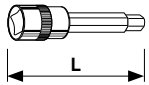

6 ● 5-6-7-8-10-12 mm

Art.	Ø	L mm
336099	1/2"	100



XZN-Vielzahn-Bit-Steckschlüssel-Satz
Jeu de douilles-embouts XZN
 Set di chiavi a bussola con inserto XZN

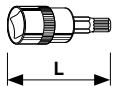

7 ● M5-M6-M8-M10-M12-M14-M16

Art.	Ø	L mm
328099	1/2"	55



XZN-Vielzahn-Lang-Bit-Steckschlüssel-Satz
Jeu de douilles-embouts longues XZN
 Set di chiavi a bussola con inserto XZN lunghe

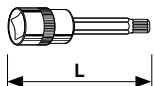

5 ● M5-M6-M8-M10-M12

Art.	Ø	L mm
338099	1/2"	100



Loch-RIBE-Bit-Steckschlüssel-Satz
Jeu de douilles-embouts RIBE creux
 Set di chiavi a bussola con inserto RIBE con foro

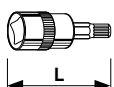

10 ● M5-M6-M7-M8-M9-M10
M11-M12-M13-M14

Art.	Ø	L mm
329099	1/2"	55



Loch-RIBE-Lang-Bit-Steckschlüssel-Satz
Jeu de douilles-embouts longues RIBE creuses
Set di chiavi a bussola con inserto RIBE lunghe con foro

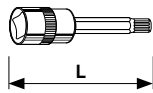

10 M5-M6-M7-M8-M9-M10
M11-M12-M13-M14

Art.	Ø	L mm
339099	1/2"	100



Alu-Stecknuss-Schiene, magnetisch
Rail magnétique en alu
Guida magnetica in alluminio

Art.	L mm	
3090	115	1/4" - 3/8" - 1/2"
3091	185	1/4" - 3/8" - 1/2"
3092	240	1/4" - 3/8" - 1/2"
3093	300	1/4" - 3/8" - 1/2"



Stecknuss-Clips
Beutel à 10 Stück
Clips pour rail magnétique
Sachet de 10 pièces
Clips per guida magnetica
Sacchetto da 10 pezzi

Art.		
3094	10 pcs	1/4"
3094B	lose, à l'unité, sfusi	1/4"
3095	10 pcs	3/8"
3095B	lose, à l'unité, sfusi	3/8"
3096	10 pcs	1/2"
3096B	lose, à l'unité, sfusi	1/2"

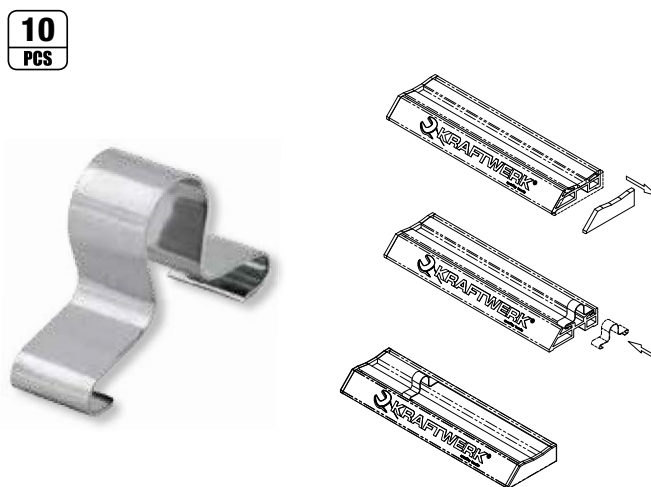

Stecknuss-Schiene

mit 16 Clips

Rail support pour douilles

avec 16 clips

Guida porta bussola

con 16 clips

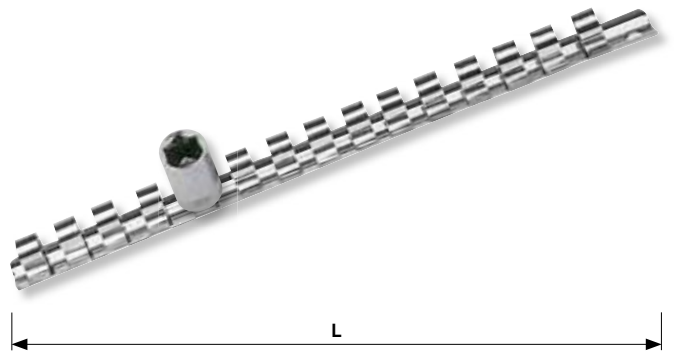

Art.	Ø	L mm	
3097	1/4"	250	16
3098	3/8"	250	16
3099	1/2"	250	10



Umschaltknarre
Cliquet réversible
Chiave a cricchetto reversibile



ERGOKRAFT

Art.	■	L mm
3200	1/4"	145
3204	1/4" kurze Ausführung / <i>modèle court</i> / modello corto	110
3200E	1/4" Reparatur-Satz / <i>Kit de réparation</i> / Kit di riparazione	-
3210	3/8"	205
3214	3/8" kurze Ausführung / <i>modèle court</i> / modello corto	135
3210E	3/8" Reparatur-Satz / <i>Kit de réparation</i> / Kit di riparazione	-
3220	1/2"	255
3220E	1/2" Reparatur-Satz / <i>Kit de réparation</i> / Kit di riparazione	-



Feinzahn-Umschaltknarre
Cliquet réversible à denture fine
Chiave a cricchetto reversibile a denti fini



Art.	■	L mm
4009	1/4"	145
4009E	1/4" Reparatur-Satz / <i>Kit de réparation</i> / Kit di riparazione	-
4019	3/8"	210
4019E	3/8" Reparatur-Satz / <i>Kit de réparation</i> / Kit di riparazione	-
4029	1/2"	245
4029E	1/2" Reparatur-Satz / <i>Kit de réparation</i> / Kit di riparazione	-



Feinzahn-Teleskop-Umschaltknarre
Cliquet réversible télescopique à denture fine
Chiave a cricchetto telescopica a denti fini



Art.	■	L mm
2000	1/4"	148 - 198
2000E	1/4" Reparatur-Satz / <i>Kit de réparation</i> / Kit di riparazione	-
2010	3/8"	215 - 315
2010E	3/8" Reparatur-Satz / <i>Kit de réparation</i> / Kit di riparazione	-
2020	1/2"	307 - 447
2020E	1/2" Reparatur-Satz / <i>Kit de réparation</i> / Kit di riparazione	-



Mini-Feinzahn-Umschaltknarre
Mini cliquet réversible à denture fine
Mini Chiave a cricchetto reversibile a denti fini

Art.		L mm
3006	1/4"	95

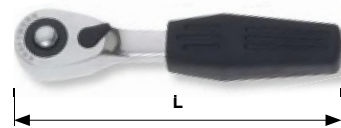



Mikro-Umschaltknarre
Micro cliquet réversible
Micro Chiave a cricchetto reversibile

Art.		L mm
3201B	1/4"	107 mm



Flexibler Mikro-Umschaltknarren-Satz
Jeu de micro cliquets réversibles articulés
Set di micro chiavi a cricchetto con testa snodata

Art.			L mm
3201F	1/4"	1/4"	108 mm

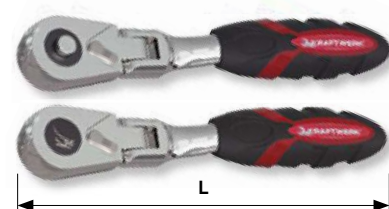

Hochleistungs-Umschaltknarre
Cliquet réversible très haute performance
Chiave a cricchetto reversibile per impieghi pesanti

Art.		L mm
4000	1/4"	153
4010	3/8"	217
4020	1/2"	261

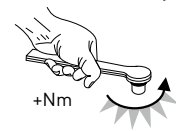

HIGHTECH FINE POWER Feinzahn-Umschaltknarre
Cliquet réversible de précision HIGHTECH FINE POWER

Chiave a cricchetto a denti fini HIGHTECH FINE POWER

1/4"

3/8"

1/2"

120

HIGHTECH FINE POWER



Art.	■	L mm
4001	1/4"	143
4001E	1/4" Reparatur-Satz / Kit de réparation / Kit di riparazione	-
4011	3/8"	205
4011E	3/8" Reparatur-Satz / Kit de réparation / Kit di riparazione	-
4021	1/2"	260
4021E	1/2" Reparatur-Satz / Kit de réparation / Kit di riparazione	-

Komposit-Umschaltknarre
Cliquet réversible en composite

Chiave a cricchetto reversibile in materiale composito

1/4"

3/8"

1/2"

48



Art.	■	L mm
3206	1/4"	143
3206E	1/4" Reparatur-Satz / Kit de réparation / Kit di riparazione	-
3216	3/8"	205
3216E	3/8" Reparatur-Satz / Kit de réparation / Kit di riparazione	-
3226	1/2"	260
3226E	1/2" Reparatur-Satz / Kit de réparation / Kit di riparazione	-

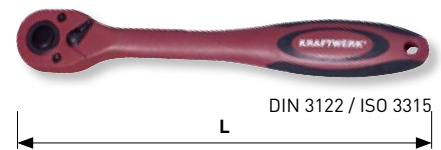

Art. 3206E / 3216E / 3226E

Drehgriff-Umschaltknarre

Für Arbeiten unter engsten Platzverhältnissen. Durch Drehen des Zweikomponenten-Griffs wird der Vierkant ohne Rückholwinkel bewegt. Vierkant-Aufnahme im Griff für Verlängerung oder T-Griff. Auch zum Einsatz als normale Ratsche mit Feinverzahnung (60 Zähne) anwendbar. Umschaltung Rechts-/Links durch Durchstecken des Antrieb-Vierkants.

Cliquets réversibles à manche rotatif

Spécialement conçus pour les zones confinées ne permettant pas les mouvements de serrage / desserrage avec un cliquet standard. Poignée ergonomique bi-matière. Carré d'entraînement adaptable sur la poignée pour rallonge. Utilisation comme un cliquet traditionnel à denture fine. Inversion (serrage / desserrage) par carré d'entraînement traversant.

Chiavi a cricchetto reversibili con impugnatura rotante

ideale per lavori in spazi stretti. Tramite la rotazione dell'impugnatura in bimatereale il cricchetto viene mosso senza angolo di ritorno. Con innesto quadro nell'impugnatura per usare come estensione o con chiavi maschio a T. Anche da usare come cricchetto normale a denti fini denti. Reversibile destro/sinistro spingendo l'attacco quadro.

Art.	■	○	L mm
3208	1/4"	60	180
3218	3/8"	60	240
3228	1/2"	60	290



Mini-Umschaltknarren-Satz

mit Umschaltknarre für 1/4" Stecknüsse und Umschaltknarre für 1/4" Bit-Direktantrieb, in eleganter Alu-Kassette.

Jeu de mini-cliquets réversibles

avec cliquet pour douilles 1/4" et cliquet avec entraînement d'embouts 1/4", dans un coffret élégant en aluminium.

Set di chiavi a cricchetto reversibili mini

con cricchetto per bussole 1/4" e cricchetto per inserti con adattamento diretta di inserti 1/4", in astuccio elegante in alluminio.

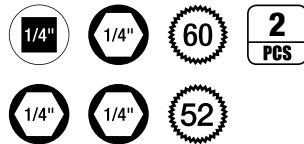

142 x 38 x 25 mm

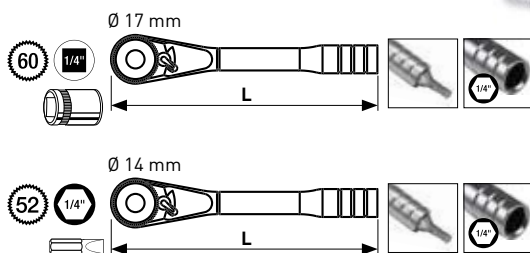

Art.	■ ○	○	L mm
4004RS	1/4"	52 / 60	95

Mini-Umschaltknarre
Mini cliquet réversible
Mini chiave a cricchetto reversibile



Art.	■ ○	○	L mm
4004R1	1/4"	60	95



Mini-Bit-Umschaltknarre
Mini cliquet réversible avec entraînement d'embouts
Mini chiave a cricchetto reversibile per inserti



Art.	○ ○	○	L mm
4004R2	1/4"	52	95



Schwerlast-Umschaltknarre
Cliquet réversible poids lourds
Chiave a cricchetto reversibile per impieghi pesanti



Art.	■	L mm
400002	3/4"	500
400003	3/4"	Teleskop télescopique telescopica 500 - 800
400002E	3/4"	Reparatur-Satz / Kit de réparation / Kit di riparazione -

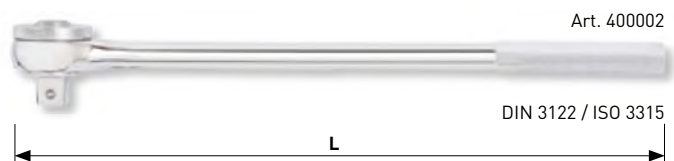

Art. 400002E

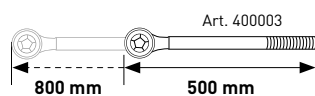

Schwerlast-Teleskop-Umschaltknarre
Cliquet réversible télescopique poids lourds
Chiave a cricchetto reversibile telescopica per impieghi pesanti

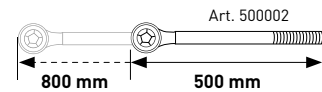

Art.	■	L mm
500002	1"	500 - 800
500002E	1" Reparatur-Satz / Kit de réparation / Kit di riparazione	-



Durchgangs-Umschaltknarre
Cliquet réversible traversant
Chiave a cricchetto reversibile passante



Art.	○	L mm
590000	13 mm	145
600000	20 mm	204
610000	30 mm	267



Klick-Drehmomentschlüssel
 präzise, mit Fensteranzeige für Werte in Nm und Lb.in.
 45-Zahn-Direkt-Umschalt-Knarrenkopf. Gehärtetes Stahlgehäuse
 und ergonomischer 2-Komponenten-Handgriff mit Adjustierungs-
 Arretierungsknopf. Zertifizierte Präzision: $\pm 4\%$.

Clé dynamométrique à déclenchement sensoriel
 de précision avec écran d'affichage des valeurs en Nm et Lb.in.
 Cliquet réversible 45 dents. Enveloppe en acier trempé, poignée
 ergonomique bi-matière avec bouton de verrouillage et de réglage.
 Précision certifiée : $\pm 4\%$.



Chiave dinamometrica
 precisa, con finestra di lettura per valori in Nm e in Lb.in.
 Movimento istantaneo reversibile a 45 denti. Robusta struttura
 con impugnatura ergonomica bimateriale con bloccaggio della
 taratura. Precisione certificata $\pm 4\%$.

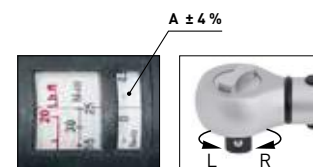

Art.	■	<~>	A Nm	L mm
3231	1/4"	2.5 - 12 Nm 20 - 105 Lb.in	0.05	285
3232	1/4"	4 - 20 Nm 30 - 180 Lb.in	0.05	285
3233	3/8"	10 - 60 Nm 9 - 45 Lb.ft	0.125	383
3234	3/8"	25 - 125 Nm 20 - 90 Lb.ft	0.25	438
3235	1/2"	40 - 200 Nm 30 - 150 Lb.ft	0.5	463
3236	1/2"	65 - 335 Nm 50 - 250 Lb.ft	0.5	523
3237	3/4"	160 - 800 Nm 120 - 600 Lb.ft	2.0	1040

Reparatur-Satz
Kit de réparation
Kit di riparazione

Art.	■	zu / pour / per
3232E	1/4"	Art. 3232
3233-34E	3/8"	Art. 3233, 3234
3235-36E	1/2"	Art. 3235, 3236
3237E	3/4"	Art. 3237



Umschaltbarer Klick-Drehmomentschlüssel-Koffer

mit Steckschlüssel und Bit-Steckschlüssel Innensechskant

Coffret de clé dynamométrique réversible à déclenchement sensoriel

avec douilles et douilles-embouts hexagonales

Set chiave dinamometrica reversibile

completo di chiavi a bussola e bussole con inserti esagonali

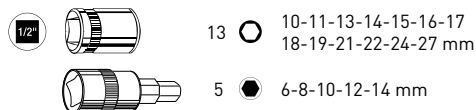

Art.	■	< ~ >
3235K1	1/2"	40 - 200 Nm 30 - 150 Lb.ft
3236K1	1/2"	65 - 335 Nm 50 - 250 Lb.ft



620 x 169 x 65 mm

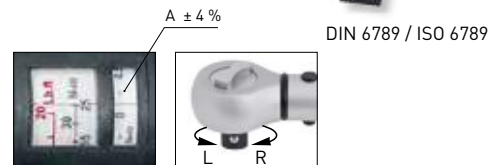

DIN 6789 / ISO 6789

Umschaltbarer Klick-Drehmomentschlüssel-Koffer

mit Steckschlüssel, Bit-Steckschlüssel Innensechskant und extra langen Schlag-Steckschlüssel

Coffret de clé dynamométrique réversible à déclenchement sensoriel

avec douilles, douilles-embouts hexagonales et douilles impact extra-longues

Set chiave dinamometrica reversibile

completo di chiavi a bussola, bussole con inserti esagonali e bussole a macchina extralunghe

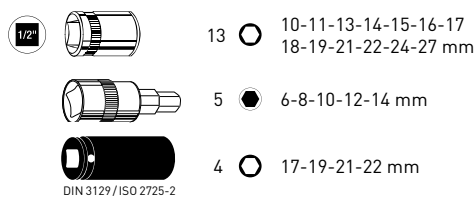

Art.	■	< ~ >
3235K2	1/2"	40 - 200 Nm 30 - 150 Lb.ft
3236K2	1/2"	65 - 335 Nm 50 - 250 Lb.ft



620 x 169 x 65 mm

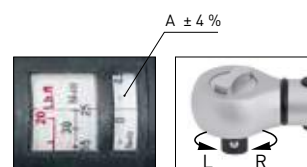

DIN 6789 / ISO 6789

Umschaltbarer Klick-Drehmomentschlüssel-Koffer

mit Steckschlüssel, Bit-Steckschlüssel Innensechskant und extra langen Schlag-Steckschlüssel mit Kunststoff-Ummantelung für Alu-Felgen



Coffret de clé dynamométrique réversible à déclenchement sensoriel

avec douilles, douilles-embouts hexagonales et douilles impact extra-longues, recouvertes de plastique pour les jantes alu

Set chiave dinamometrica reversibile

completo di chiavi a bussola, bussole con inserti esagonali e bussola a macchina extralunghe rivestite in plastica per cerchi in lega

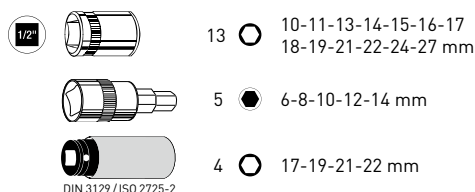

620 x 169 x 65 mm

DIN 6789 / ISO 6789

Art.	■	<-->
3235K3	1/2"	40 - 200 Nm 30 - 150 Lb.ft
3236K3	1/2"	65 - 335 Nm 50 - 250 Lb.ft

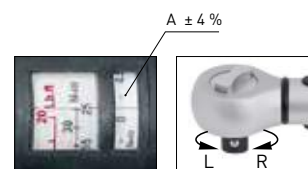

Klick-Drehmomentschlüssel

präzise, mit Fensteranzeige für Werte in Nm und Lb.ft. Rechteckige Aufnahme für auswechselbare Schlüssel-Einsätze 14 x 18 mm. Gehärtetes Stahlgehäuse und ergonomischer 2-Komponenten-Handgriff mit Ajustierungs-Arretierungsknopf. Zertifizierte Präzision: $\pm 4\%$.

Clé dynamométrique à déclenchement sensoriel

de précision avec écran d'affichage des valeurs en Nm et Lb.ft. À têtes interchangeables 14 x 18 mm. Enveloppe en acier trempé, poignée ergonomique bi-matière avec bouton de verrouillage et de réglage.

Précision certifiée : $\pm 4\%$.

Barra dinamometrica

precisa, con finestra di lettura per valori in Nm e in Lb.ft. Attacco rettangolare per inserti da 14 x 18 mm. Robusta struttura con impugnatura ergonomica bimatereale con bloccaggio della taratura. Precisione certificata $\pm 4\%$.

14x18



Art. 3235H



Art. 3236H

Art.	□	<-->
3235H	14 x 18 mm	40 - 200 Nm 30 - 150 Lb.ft
3236H	14 x 18 mm	65 - 335 Nm 50 - 250 Lb.ft

Klick-Drehmomentschlüssel-Koffer
mit Einsteck-Maulschlüsseln und -Hochleistungs-Umschaltknarre

Coffret de clé dynamométrique à déclenchement sensoriel

avec têtes fourches interchangeable et tête-clicquet réversible haute performance.

Set chiave dinamometrica

completo di teste a forchetta e chiave a cricchetto reversibile per impieghi pesanti

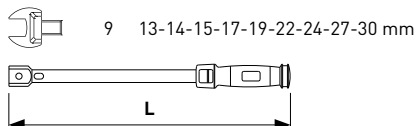

620 x 169 x 65 mm

Art. 3235GK1

DIN 6789 / ISO 6789

Art.	■ ■	mit / avec / con	<-->	L mm	
3235GK1	14 x 18 mm 1/2"	24	Hochleistungs-Umschaltknarre <i>Tête-clicquet réversible haute performance</i> Testa cricchetto reversibile per impieghi pesanti	40 - 200 Nm 30 - 150 Lb.ft	463
3236GK1	14 x 18 mm 1/2"	24	Hochleistungs-Umschaltknarre <i>Tête-clicquet réversible haute performance</i> Testa cricchetto reversibile per impieghi pesanti	65 - 335 Nm 50 - 250 Lb.ft	523
3235GK2	14 x 18 mm 1/2"	72	Feinzahn-Umschaltknarre <i>Tête-clicquet réversible à denture fine</i> Testa cricchetto reversibile a denti fini	40 - 200 Nm 30 - 150 Lb.ft	463
3236GK2	14 x 18 mm 1/2"	72	Feinzahn-Umschaltknarre <i>Tête-clicquet réversible à denture fine</i> Testa cricchetto reversibile a denti fini	65 - 335 Nm 50 - 250 Lb.ft	523

Einsteck-Maulschlüssel

zu Drehmomentschlüssel 3235H / 3236H

Tête fourche interchangeable

pour clés dynamométriques 3235H / 3236H

Testa a forchetta intercambiabile

per chiavi dinamometriche 3235H / 3236H



Art.	■	
3235-G13	14 x 18 mm	13 mm
3235-G14	14 x 18 mm	14 mm
3235-G15	14 x 18 mm	15 mm
3235-G17	14 x 18 mm	17 mm
3235-G19	14 x 18 mm	19 mm
3235-G22	14 x 18 mm	22 mm
3235-G24	14 x 18 mm	24 mm
3235-G27	14 x 18 mm	27 mm
3235-G30	14 x 18 mm	30 mm



Klick-Drehmomentschlüssel-Koffer

mit Einsteck-Ringschlüssel

Coffret de clé dynamométrique à déclenchement sensoriel

avec têtes polygonales interchangeables

Set chiave dinamometrica

completo di teste poligonali

9 13-14-15-17-19-22-24-27-30 mm

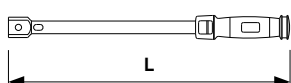

620 x 169 x 65 mm

Art. 3235RK1

DIN 6789 / ISO 6789

Art.		mit / avec / con	< - >	L mm
3235RK1	14 x 18 mm 1/2"	Hochleistungs-Umschaltknarre <i>Tête-cliquet réversible de haute performance</i> Testa cricchetto reversibile per impieghi pesanti	40 - 200 Nm 30 - 150 Lb.ft	463
3236RK1	14 x 18 mm 1/2"	Hochleistungs-Umschaltknarre <i>Tête-cliquet réversible de haute performance</i> Testa cricchetto reversibile per impieghi pesanti	65 - 335 Nm 50 - 250 Lb.ft	523
3235RK2	14 x 18 mm 1/2"	Feinzahn-Umschaltknarre <i>Tête-cliquet réversible à denture fine</i> Testa cricchetto reversibile a denti fini	40 - 200 Nm 30 - 150 Lb.ft	463
3236RK2	14 x 18 mm 1/2"	Feinzahn-Umschaltknarre <i>Tête-cliquet réversible à denture fine</i> Testa cricchetto reversibile a denti fini	65 - 335 Nm 50 - 250 Lb.ft	523

Einsteck-Ringschlüssel

zu Drehmomentschlüssel 3235H / 3236H

Tête polygonale interchangeable

pour clés dynamométriques 3235H / 3236H

Testa poligonale intercambiabile

per chiavi dinamometriche 3235H / 3236H



Art.		
3235-R13	14 x 18 mm	13 mm
3235-R14	14 x 18 mm	14 mm
3235-R15	14 x 18 mm	15 mm
3235-R17	14 x 18 mm	17 mm
3235-R19	14 x 18 mm	19 mm
3235-R22	14 x 18 mm	22 mm
3235-R24	14 x 18 mm	24 mm
3235-R27	14 x 18 mm	27 mm
3235-R30	14 x 18 mm	30 mm



Einsteck-Hochleistungs-Umschaltknarre

zu Drehmomentschlüssel 3235H / 3236H

Tête-cliquet réversible haute performance

pour clés dynamométriques 3235H / 3236H

Testa cricchetto reversibile per impieghi pesanti

per barre dinamometriche 3235H / 3236H

Art.	○	■	■
3235-U12P	24	14 x 18 mm	1/2"



Einsteck-Feinzahn-Umschaltknarre

zu Drehmomentschlüssel 3235H / 3236H

Tête-cliquet réversible à denture fine

pour clés dynamométriques 3235H / 3236H

Testa cricchetto reversibile a denti fini

per barre dinamometriche 3235H / 3236H

Art.	○	■	■
3235-U12R	72	14 x 18 mm	1/2"



Drehmomentschlüssel

mit feiner Skaleneinteilung in Nm und Lb.ft. Gehärtetes Stahlgehäuse mit integriertem Umschalthebel mit Freilauffunktion.

Clé dynamométrique

avec graduation fine en Nm et en Lb.ft. Corps en acier trempé avec poignée de réglage intégrée avec fonction débrayage.

Chiave dinamometrica

con graduazione fina in Nm e in Lb.ft. Rivestimento in acciaio indurito con leva di commutazione con funzione a ruota libera integrata.

Art.	■	< ~ >	L mm
2045	1/2"	42 - 210 Nm 31 - 154.9 Lb.ft	450
2045E	1/2"	Reparatur-Satz Kit de réparation Kit di riparazione	



DIN ISO 6789

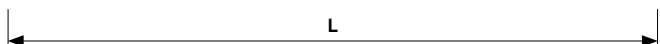

QUICKLOCK



Art. 2045E

Schlag-Drehmomentbegrenzungs-Verlängerungs-Satz

für die Begrenzung des Drehmoments bei Verwendung von Schlagschraubern.

Jeu de rallonges pour limitation des couples à choc

pour la limitation des couples lors de l'usage de boulonneuses.

Assortimento di prolunghe a macchina per limitazione della coppia

per la limitazione della coppia durante l'utilizzo di avvitatori a percussione.

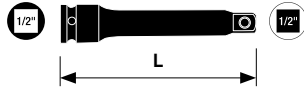

- 110 Nm - 80 Lb.ft
- 120 Nm - 90 Lb.ft
- 135 Nm - 100 Lb.ft
- 150 Nm - 110 Lb.ft

Art.	○	■	L mm
387200	1/2"	1/2"	200



Canvas

Elektronischer Drehmoment-Adapter

Kann mit jedem Antriebselement, z.B. herkömmlichen Umschaltknarren als Drehmomentvorsatz verwendet werden.

- Automatische Nullstellung beim Einschalten
- Direkte Messwertanzeige oder Sollwert-Programmierung mit optischer und akustischer Warnung beim Erreichen oder Überschreiten des Sollwertes
- Track- / Peak-Mode
- Messgenauigkeit $\pm 2\%$ Toleranz
- 50 Speicherplätze
- Inkl. Batterien mit Prüfzertifikat nach DIN EN ISO 6789.



DIN EN ISO 6789

Adaptateur dynamométrique électronique

S'utilise avec tous types d'outils à carré conducteur (cliquets, barres de force, clés en croix...) développant un couple de serrage.

- Remise à zéro automatique lors de la mise en route
- Lecture directe sur l'afficheur des données mesurées et des tolérances. Signal visuel et sonore d'atteinte et/ou de dépassement du couple programmé
- Track-peak mode: Affichage de l'évolution des forces de serrage jusqu'à atteinte du couple souhaité
- Précision de mesure: tolérance $\pm 2\%$
- Mémorisation jusqu'à 50 données de mesure
- Inclus piles et certificat de contrôle norme DIN EN ISO 6789.

Misuratore elettronico di coppia

Trasforma ogni chiave a cricchetto convenzionale o leva di manovra in una precisa chiave dinamometrica elettronica.

- Taratura automatica a zero al momento dell'accensione
- Chiara indicazione della coppia o del set up della coppia, indicazione tramite un avvertimento visivo e acustico al raggiungimento o al superamento della coppia predeterminata
- Modalità traccia/picco: mostra l'evoluzione delle forze di serraggio fino al raggiungimento della coppia desiderata
- Precisione di misurazione : tolleranza $\pm 2\%$
- 50 memorie
- Batterie e certificato di collaudo DIN EN ISO 6789 inclusi.

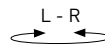

Art.	■	< ~ > $\pm 2\%$	3V Li-Mn CR-2032	⊕	B x L x H mm
4081-14	1/4"	6 - 30 Nm 4.4 - 22.1 Lb.ft	1x	55 h	122 x 190 x 64 (BMC)
4081-38	3/8"	27 - 135 Nm 19.9 - 99.6 Lb.ft	1x	55 h	122 x 190 x 64 (BMC)
4081-12	1/2"	40 - 200 Nm 29.5 - 147.5 Lb.ft	1x	55 h	122 x 190 x 64 (BMC)
Art.	■	< ~ > +/- 2%	1.5V LR6-AA	⊕	L x B x H mm
4081-34	3/4"	100 - 500 Nm 73.8 - 369 Lb.ft	2x	110 h	156 x 110 x 80 (BMC)
4081-341	3/4"	200 - 1000 Nm 147.6 - 738 Lb.ft	2x	110 h	156 x 110 x 80 (BMC)

Drehwinkel-Messgerät
Clé de serrage angulaire
Chiave di serraggio angolare

Art.	■
2037	1/2"

1/2"



Drehwinkel-Messgerät mit Magnetarm
Clé de serrage angulaire avec aimant
Chiave di serraggio angolare con braccio magnetico

Art.	■
2038.1	1/2"

1/2"



Drehwinkel-Messgerät mit Cliparm
Clé de serrage angulaire avec pince
Chiave di serraggio angolare con braccio pinza

Art.	■
2038.2	1/2"

1/2"



Steckschlüssel-Einsatz
Douille
Chiave a bussola

Art.	⊙	⊙ mm	D1 mm	D2 mm	L mm
100035	1/4"	3.5	11.8	6.1	25
100040	1/4"	4	11.8	6.7	25
100045	1/4"	4.5	11.8	7.3	25
100050	1/4"	5	11.8	8.0	25
100055	1/4"	5.5	11.8	8.6	25
100060	1/4"	6	11.8	9.2	25
100070	1/4"	7	11.8	10.7	25
100080	1/4"	8	11.8	11.8	25
100090	1/4"	9	13.0	13.0	25
100100	1/4"	10	14.3	14.3	25
100110	1/4"	11	15.8	15.8	25
100120	1/4"	12	16.8	16.8	25
100130	1/4"	13	17.8	17.8	25
100140	1/4"	14	19.8	19.8	25



DIN 3124 / ISO 2725-1

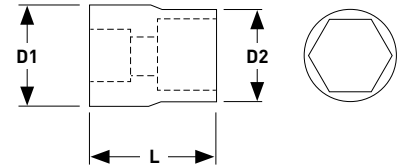

schont Schrauben und Werkzeug
ménage l'écrou et l'outil
protege le viti e l'utensile



Steckschlüssel-Einsatz Zollmass
Douille en pouce
Chiave a bussola in pollici

Art.	⊙	⊙ inch	D1 mm	D2 mm	L mm
100503	1/4"	3/16"	11.8	7.8	25
100504	1/4"	7/32"	11.8	8.5	25
100505	1/4"	1/4"	11.8	9.5	25
100506	1/4"	9/32"	11.8	10.7	25
100507	1/4"	5/16"	11.8	11.8	25
100508	1/4"	11/32"	13.0	13.0	25
100509	1/4"	3/8"	14.2	14.2	25
100510	1/4"	7/16"	15.7	15.7	25
100511	1/4"	1/2"	17.7	17.7	25



DIN 3124 / ISO 2725-1

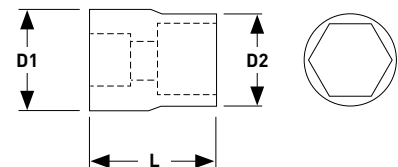

Steckschlüssel-Einsatz, lang
Douille longue
Chiave a bussola tipo lungo



Art.	⊘	⊘ mm	D1 mm	D2 mm	L mm
101040	1/4"	4	11.9	6.7	50
101045	1/4"	4.5	11.9	7.5	50
101050	1/4"	5	11.9	8.0	50
101055	1/4"	5.5	11.9	8.7	50
101060	1/4"	6	11.9	9.2	50
101070	1/4"	7	11.9	10.8	50
101080	1/4"	8	11.9	11.9	50
101090	1/4"	9	13.1	13.1	50
101100	1/4"	10	14.6	14.6	50
101110	1/4"	11	15.9	15.9	50
101120	1/4"	12	16.9	16.9	50
101130	1/4"	13	17.9	17.9	50



DIN 3124 / ISO 2725-1

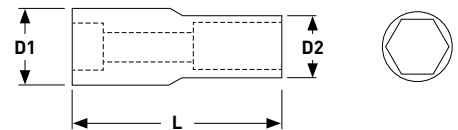

Steckschlüssel-Einsatz, lang, Zollmass
Douille longue en pouce
Chiave a bussola tipo lungo in pollici



Art.	⊘	⊘ inch	D1 mm	D2 mm	L mm
101503	1/4"	3/16"	11.9	7.9	50
101504	1/4"	7/32"	11.9	8.9	50
101505	1/4"	1/4"	11.9	9.9	50
101506	1/4"	9/32"	11.9	11.0	50
101507	1/4"	5/16"	11.9	11.9	50
101508	1/4"	11/32"	13.1	13.1	50
101509	1/4"	3/8"	14.6	14.6	50
101510	1/4"	7/16"	15.9	15.9	50
101511	1/4"	1/2"	17.9	17.9	50

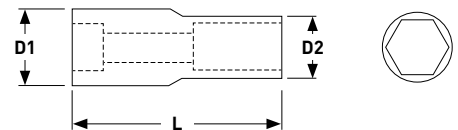

COMBI-Steckschlüssel-Einsatz
Douille COMBI multi-empreinte
Chiave a bussola COMBI

Art.	⊙	⊙ mm	⊙ inch	⊕	⊙ XZN	D1 mm	D2 mm	L mm
130040	1/4"	4	5/32"	E5	M5	11.8	6.8	25
130045	1/4"	4.5	3/16"	E6		11.8	7.3	25
130050	1/4"	5	3/16" 13/64"		M6	11.8	7.9	25
130055	1/4"	5.5	7/32"	E7		11.8	8.7	25
130060	1/4"	6	1/4"	E8	M8	11.8	9.3	25
130070	1/4"	7	9/32"			11.8	10.6	25
130080	1/4"	8	5/16"	E10	M10	11.8	12.8	25
130090	1/4"	9	11/32"			11.8	12.8	25
130100	1/4"	10	3/8"	E12	M12	13.8	15.8	25
130110	1/4"	11	7/16"	E14	M14	13.8	15.8	25
130120	1/4"	12	15/32"	E16		14.8	16.8	25
130130	1/4"	13	1/2"		M16	15.8	17.8	25
130140	1/4"	14	9/16"	E18	M18	17.8	19.8	25

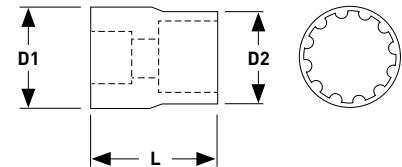
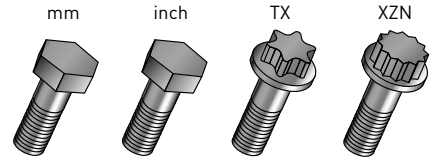

Durchgangs-Steckschlüssel-Einsatz

ermöglicht das Schrauben auf langen Bolzen und Gewindestangen

Douille traversante

permet le vissage et dévissage des boulons longs et des tiges filetées

Chiave a bussola passanti

permette il serraggio di viti lunghe e prigionieri



13 mm

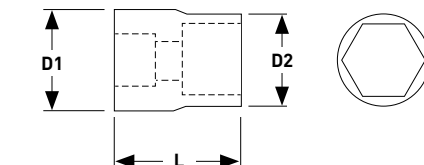

Art.	mm	mm	D1 mm	D2 mm	L mm
590035	13	3.5	13	5.4	25
590040	13	4	13	6.0	25
590045	13	4.5	13	6.6	25
590050	13	5	13	7.1	25
590055	13	5.5	13	8.2	25
590060	13	6	13	9.3	25
590070	13	7	13	10.0	25
590080	13	8	13	11.5	25
590090	13	9	13	12.5	25
590100	13	10	13	14.2	25
590110	13	11	13	15.3	25
590120	13	12	13	16.5	25
590130	13	13	13	17.4	25

Steckschlüssel-Einsatz Aussen-TX

Douille TX femelle

Chiave a bussola TX esterno



1/4"

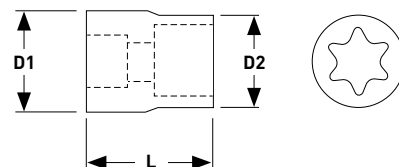

Art.	mm	mm	D1 mm	D2 mm	L mm
120004	1/4"	E4	11.9	7.2	25
120005	1/4"	E5	11.9	8.0	25
120006	1/4"	E6	11.9	8.0	25
120007	1/4"	E7	11.9	8.9	25
120008	1/4"	E8	11.9	10.3	25
120010	1/4"	E10	12.7	12.7	25
120011	1/4"	E11	14.1	14.1	25

Bit-Steckschlüssel-Einsatz Schlitz

Douille-embout vis à fente

Chiave a bussola con inserto ad intaglio

Art.	⊙	mm	L mm
102040	1/4"	0.5 x 4.0	38
102055	1/4"	0.8 x 5.5	38
102065	1/4"	1.0 x 6.5	38



Bit-Steckschlüssel-Einsatz Phillips

Douille-embout Phillips

Chiave a bussola con inserto Phillips

Art.	⊙	+	L mm
103001	1/4"	PH 1	38
103002	1/4"	PH 2	38
103003	1/4"	PH 3	38



Bit-Steckschlüssel-Einsatz Pozidriv

Douille-embout Pozidriv

Chiave a bussola con inserto Pozidriv

Art.	⊙	+	L mm
104000	1/4"	PZ 0	38
104001	1/4"	PZ 1	38
104002	1/4"	PZ 2	38
104003	1/4"	PZ 3	38



Bit-Steckschlüssel-Einsatz TX

Douille-embout TX

Chiave a bussola con inserto TX

Art.	⊙	★	L mm
105008	1/4"	T8	38
105010	1/4"	T10	38
105015	1/4"	T15	38
105020	1/4"	T20	38
105025	1/4"	T25	38
105027	1/4"	T27	38
105030	1/4"	T30	38
105040	1/4"	T40	38



Bit-Steckschlüssel-Einsatz 5-Stern-TX

Douille-embout TX 5 pans

Chiave a bussola con inserto TX 5 punte



Art.	Ø	★	L mm
115008	1/4"	TS 8	38
115009	1/4"	TS 9	38
115010	1/4"	TS 10	38
115015	1/4"	TS 15	38
115020	1/4"	TS 20	38
115025	1/4"	TS 25	38
115027	1/4"	TS 27	38
115030	1/4"	TS 30	38
115040	1/4"	TS 40	38



Bit-Steckschlüssel-Einsatz 5-Stern-Loch-TX

Douille-embout TX 5 pans creuse

Chiave a bussola con inserto TX 5 punte con foro



Art.	Ø	★	L mm
115308	1/4"	TS 8	38
115309	1/4"	TS 9	38
115310	1/4"	TS 10	38
115315	1/4"	TS 15	38
115320	1/4"	TS 20	38
115325	1/4"	TS 25	38
115327	1/4"	TS 27	38
115330	1/4"	TS 30	38
115340	1/4"	TS 40	38



Bit-Steckschlüssel-Einsatz Innensechskant

Douille-embout hexagonale

Chiave a bussola con inserto esagonale



Art.	Ø	mm	L mm
106003	1/4"	3	38
106004	1/4"	4	38
106005	1/4"	5	38
106006	1/4"	6	38
106007	1/4"	7	38
106008	1/4"	8	38



Bit-Steckschlüssel-Einsatz Innensechskant Zollmass
Douille-embout hexagonale en pouce
Chiave a bussola con inserto esagonale in pollici

Art.	⊘	● inch	L mm
106501	1/4"	1/8"	38
106502	1/4"	5/32"	38
106503	1/4"	3/16"	38
106504	1/4"	7/32"	38
106505	1/4"	1/4"	38



Verlängerung
Rallonge
Prolunga

Art.	⊘	■	L mm
107050	1/4"	1/4"	50
107100	1/4"	1/4"	100



Duplex Winkel-Verlängerung
Rallonge tête angulaire duplex
Prolunga punto angolare duplex

Art.	⊘	■	L mm
107101	1/4"	1/4"	100
107151	1/4"	1/4"	150

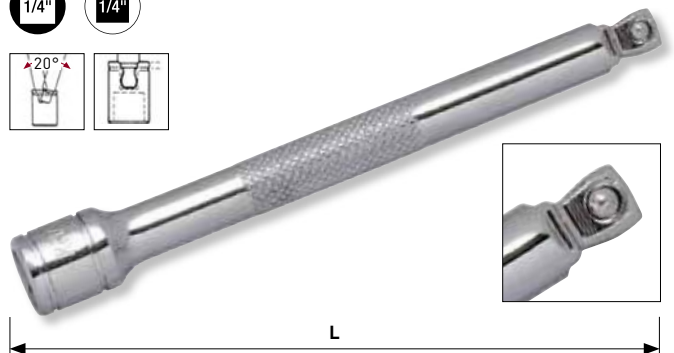
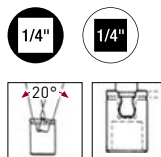

Verriegelungs-Verlängerung
Rallonge à verrouillage
Prolunga con blocco

Art.	⊘	■	L mm
107102	1/4"	1/4"	100



Satz / Set / Set Art.123002
204

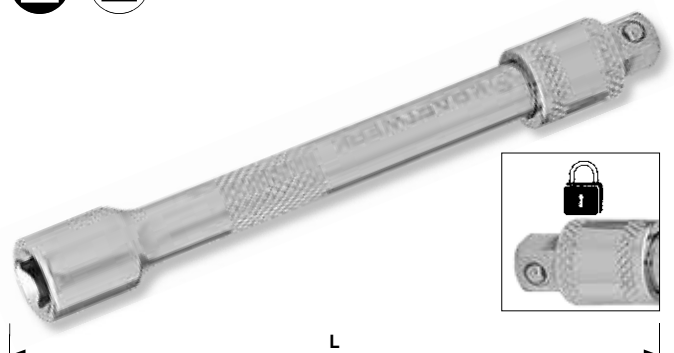

Flexible Verlängerung
Rallonge flexible
Prolunga flessibile

Art.			L mm
107155	1/4"	1/4"	146

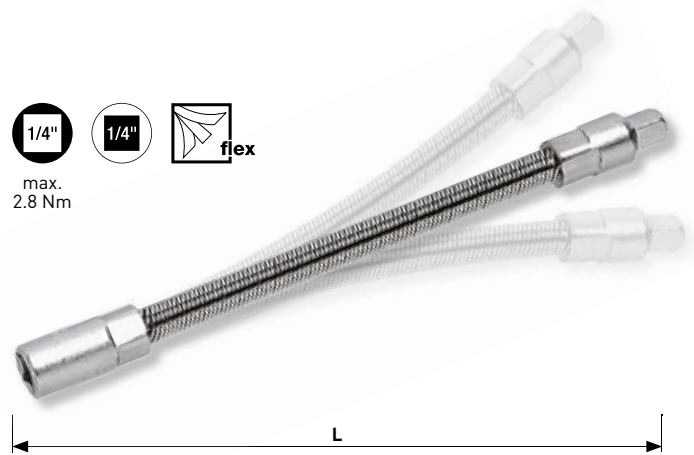

Flexible Verlängerung für Bits
Rallonge flexible pour embouts
Prolunga flessibile per inserti

Art.			L mm
107140	1/4"	1/4"	140

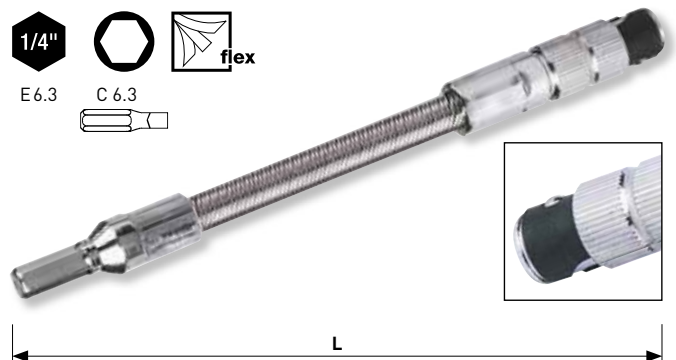
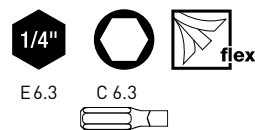

Durchgangs-Verlängerung



ermöglicht das Schrauben auf langen Bolzen und Gewindestangen

Rallonge traversante

permet le vissage et dévissage des boulons longs et des tiges filetées

Prolunga passanti

permette il serraggio di viti lunghe e prigionieri

Art.			L mm
597075	13	13	75

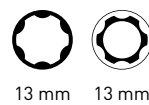

Biegsame Schrauberwelle für Stecknüsse
Rallonge flexible haute résistance pour douilles
Porta bussole con estensione flessibile ad alta resistenza



Art.			L mm
107330	1/4"	1/4"	≈ 330



Biessame Schrauberwelle für Bits

Rallonge flexible haute résistance pour embouts

Porta inserti con estensione flessibile ad alta resistenza



Art.			L mm
107331	1/4"	1/4"	330

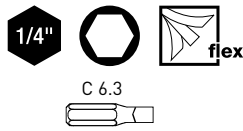

Steckschlüssel mit Griff, flexibel

Rallonge flexible avec manche

Giravite flessibile a bussola con impugnatura

Art.	Ø mm	L1 mm	L2 mm
109060	6	158	270
109070	7	158	270
109080	8	158	270
109090	9	158	292
109100	10	176	292
109110	11	176	292



Steckgriff

mit 1/4" Innenvierkant im Griffende

Rallonge

avec manche carré

Porta bussole

con attacco quadro da 1/4" all'interno dell'impugnatura

Art.			L1 mm	L2 mm
109150	1/4"	1/4"	70	155

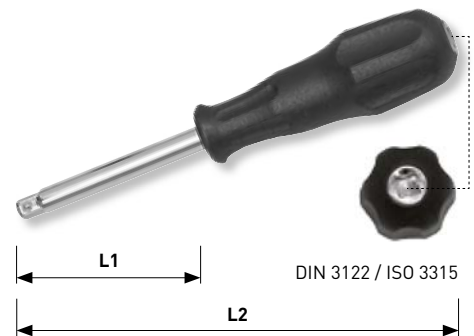

2-Komponenten-Steckgriff

mit 1/4" Innenvierkant im Griffende

Rallonge à manche bi-matière

avec manche carré

Porta bussole con impugnatura bimateriale

con attacco quadro da 1/4" all'interno dell'impugnatura

Art.			L1 mm	L2 mm
109151	1/4"	1/4"	51	153



Flexibler 2-Komponenten-Steckgriff
Rallonge flexible avec manche bi-matière
Porta bussole flessibile con impugnatura bimateriale

Art.	□	L1 mm	L2 mm
109175	1/4"	158	270

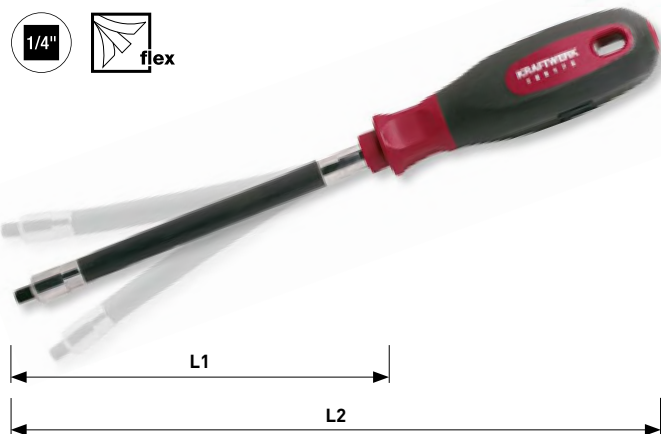

T-Gleitgriff-Adapter
Adaptateur pour poignée coulissante
Quadro scorrevole

Art.	○	□	L mm
108000	1/4"	1/4"	22



Gleitgriff
Poignée coulissante
Quadro maschio con spina scorrevole

Art.	○	□	L mm
108100	1/4"	1/4"	105



Kardangelenk
Cardan
Snodo cardanico

Art.	○	□	L mm
110000	1/4"	1/4"	35



Schnellverriegelungs-Kardangelnk
Cardan de verrouillage à changement rapide
Adattatore universale snodato con blocco ed attacco rapido



Satz / Set / Set Art.123102
205

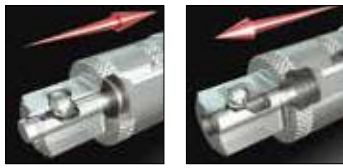

Art.			L mm
123102-14	1/4"	1/4"	55



Stecknuss-Adapter

zu Durchgangs-Umschaltknarre 590000

Adaptateur de douilles

pour cliquet réversible traversant 590000

Adattatore per chiavi a bussola

per chiave a cricchetto reversibile passante 590000



Art.	mm		L mm
591140	13	1/4"	25

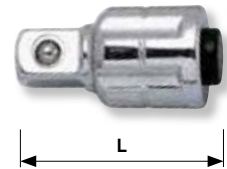

Bit-Adapter

zu Durchgangs-Umschaltknarre 590000

Adaptateur d'embouts

pour cliquet réversible traversant 590000

Adattatore per inserti

per chiave a cricchetto reversibile passante 590000

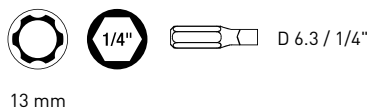

Art.	mm		L mm
592760	13	1/4"	22



Adapter für Bits

Douille porte-embouts

Adattatore per inserti

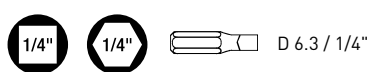

Art.			L mm
2760	1/4"	1/4"	25



Steckschlüssel-Einsatz

Douille

Chiave a bussola

Art.	⊘	⊘ mm	D1 mm	D2 mm	L mm
200060	3/8"	6	17.0	9.3	25
200070	3/8"	7	17.0	10.8	25
200080	3/8"	8	17.0	12.0	25
200090	3/8"	9	17.0	12.9	25
200100	3/8"	10	17.0	14.5	25
200110	3/8"	11	17.0	15.8	25
200120	3/8"	12	17.0	17.0	25
200130	3/8"	13	18.9	18.9	25
200140	3/8"	14	19.5	19.5	25
200150	3/8"	15	20.8	20.8	25
200160	3/8"	16	22.0	22.0	25
200170	3/8"	17	23.3	23.3	25
200180	3/8"	18	24.0	24.0	25
200190	3/8"	19	24.0	25.8	26
200200	3/8"	20	24.0	27.7	29
200210	3/8"	21	25.0	27.9	29
200220	3/8"	22	26.0	29.5	32
200240	3/8"	24	26.0	31.9	32



DIN 3124 / ISO 2725-1

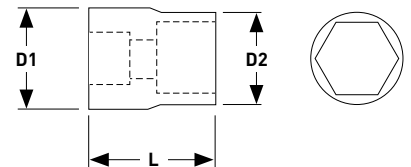

schont Schrauben und Werkzeug
ménage l'écrou et l'outil
 protegge le viti e l'utensile



Steckschlüssel-Einsatz Zollmass

Douille en pouce

Chiave a bussola in pollici

Art.	⊘	⊘ inch	D1 mm	D2 mm	L mm
200505	3/8"	1/4"	17.2	10.0	25
200507	3/8"	5/16"	17.2	11.7	25
200509	3/8"	3/8"	17.2	13.8	25
200510	3/8"	7/16"	17.2	16.0	25
200511	3/8"	1/2"	17.9	17.9	25
200512	3/8"	9/16"	19.7	19.7	25
200513	3/8"	5/8"	22.2	22.2	25
200514	3/8"	11/16"	23.9	23.9	25
200515	3/8"	3/4"	25.9	25.9	25
200516	3/8"	13/16"	27.9	27.9	29
200517	3/8"	7/8"	29.7	29.7	29
200518	3/8"	15/16"	31.9	31.9	29
200519	3/8"	1"	33.9	33.9	29

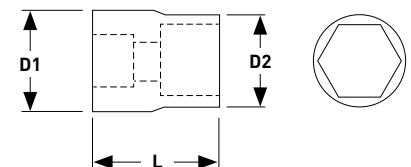

Steckschlüssel-Einsatz, lang
Douille longue
Chiave a bussola tipo lungo

Art.	⊘	⊘ mm	D1 mm	D2 mm	L mm
201080	3/8"	8	16.8	12.0	64
201100	3/8"	10	16.8	14.4	64
201110	3/8"	11	16.8	15.9	64
201120	3/8"	12	16.8	16.8	64
201130	3/8"	13	18.8	18.8	64
201140	3/8"	14	19.8	19.8	64
201150	3/8"	15	20.4	20.4	64
201170	3/8"	17	23.8	23.8	64
201180	3/8"	18	23.8	23.8	64
201190	3/8"	19	26.0	26.0	64
201220	3/8"	22	29.5	29.5	64



DIN 3124 / ISO 2725-1

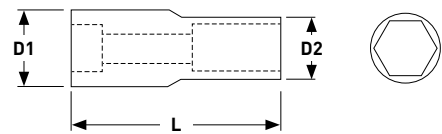

Zündkerzen-Steckschlüssel-Einsatz
Douille pour bougie
Chiave a bussola per candele

Art.	⊘	⊘ mm	D mm	L mm
201114	3/8"	14	18	64
201160	3/8"	16	22	64
201118	3/8"	18	23.8	64
201210	3/8"	21	27.3	64

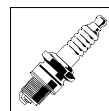

AUTOMOTIVE



Steckschlüssel-Einsatz, lang, Zollmass
Douille longue en pouce
Chiave a bussola tipo lungo in pollici

Art.	⊘	⊘ inch	D1 mm	D2 mm	L mm
201509	3/8"	3/8"	16.8	14.4	64
201510	3/8"	7/16"	16.8	16.0	64
201511	3/8"	1/2"	17.8	17.8	64
201512	3/8"	9/16"	19.8	19.8	64
201514	3/8"	11/16"	23.8	23.8	64
201515	3/8"	3/4"	25.8	25.8	64
201517	3/8"	7/8"	29.8	29.8	64

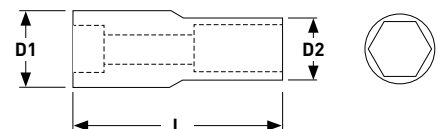

Zündkerzen-Steckschlüssel-Einsatz Zollmass
Douille pour bougie en pouce
Chiave a bussola per candele in pollici

Art.	⊘	⊘ inch	D mm	L mm
201513	3/8"	5/8"	22.0	64
201516	3/8"	13/16"	27.2	70

Durchgangs-Steckschlüssel-Einsatz
 ermöglicht das Schrauben auf langen Bolzen und Gewindestangen
Douille traversante
 permet le vissage et dévissage des boulons longs et des tiges filetées

Chiave a bussola passanti
 permette il serraggio di viti lunghe e prigionieri

Art.	⊘ mm	⊘ mm	D1 mm	D2 mm	L mm
600100	20	10	20	14.6	32
600110	20	11	20	15.3	32
600120	20	12	20	16.6	32
600130	20	13	20	17.7	32
600140	20	14	20	18.8	32
600150	20	15	20	20.0	32
600160	20	16	20	21.2	32
600170	20	17	20	22.5	32
600180	20	18	20	23.6	32
600190	20	19	20	24.4	32

Steckschlüssel-Einsatz Aussen-TX
Douille TX femelle
Chiave a bussola TX esterno

Art.	⊘	⊘	D1 mm	D2 mm	L mm
220004	3/8"	E4	16.8	7.1	26
220005	3/8"	E5	16.8	8.0	26
220006	3/8"	E6	16.8	8.0	26
220007	3/8"	E7	16.8	9.0	26
220008	3/8"	E8	16.8	10.5	26
220010	3/8"	E10	16.8	13.0	26
220011	3/8"	E11	16.8	14.0	26
220012	3/8"	E12	16.8	15.5	26
220014	3/8"	E14	18.9	18.9	28
220016	3/8"	E16	18.9	18.9	28
220018	3/8"	E18	19.8	19.8	28
220020	3/8"	E20	21.8	21.8	30



AUTOMOTIVE

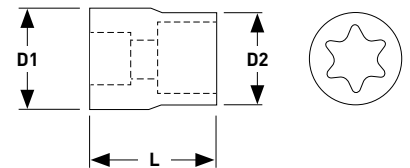
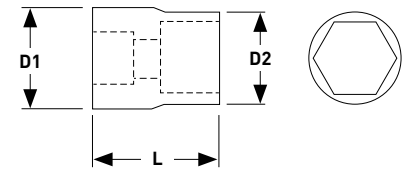
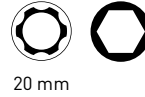
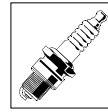

Bit-Steckschlüssel-Einsatz Schlitz
Douille-embout vis à fente
Chiave a bussola con inserto ad intaglio

Art.	Ø	mm	L mm
202055	3/8"	0.8 x 5.5	48
202065	3/8"	1.0 x 6.5	48
202080	3/8"	1.6 x 8.0	48



Bit-Steckschlüssel-Einsatz Phillips
Douille-embout Phillips
Chiave a bussola con inserto Phillips

Art.	Ø	+	L mm
203001	3/8"	PH 1	48
203002	3/8"	PH 2	48
203003	3/8"	PH 3	48



Bit-Steckschlüssel-Einsatz Pozidriv
Douille-embout Pozidriv
Chiave a bussola con inserto Pozidriv

Art.	Ø	+	L mm
204001	3/8"	PZ 1	48
204002	3/8"	PZ 2	48
204003	3/8"	PZ 3	48



Bit-Steckschlüssel-Einsatz TX
Douille-embout TX
Chiave a bussola con inserto TX

Art.	Ø	★	L mm
205010	3/8"	T10	48
205015	3/8"	T15	48
205020	3/8"	T20	48
205025	3/8"	T25	48
205027	3/8"	T27	48
205030	3/8"	T30	48
205040	3/8"	T40	48
205045	3/8"	T45	48
205050	3/8"	T50	48
205055	3/8"	T55	48
205060	3/8"	T60	48

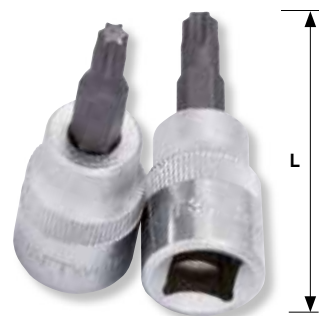

Bit-Steckschlüssel-Einsatz Loch-TX

Douille-embout TX creuse

Chiave a bussola con inserto TX con foro

Art.	Ø	☆	L mm
205310	3/8"	T10	48
205315	3/8"	T15	48
205320	3/8"	T20	48
205325	3/8"	T25	48
205327	3/8"	T27	48
205330	3/8"	T30	48
205340	3/8"	T40	48
205345	3/8"	T45	48
205350	3/8"	T50	48
205355	3/8"	T55	48
205360	3/8"	T60	48



Bit-Steckschlüssel-Einsatz Innensechskant

Douille-embout hexagonale

Chiave a bussola con inserto esagonale

Art.	Ø	● mm	L mm
206003	3/8"	3	48
206004	3/8"	4	48
206005	3/8"	5	48
206006	3/8"	6	48
206007	3/8"	7	48
206008	3/8"	8	48
206010	3/8"	10	48



Bit-Steckschlüssel-Einsatz Innensechskant Zollmass

Douille-embout hexagonale en pouce

Chiave a bussola con inserto esagonale in pollici

Art.	Ø	● inch	L mm
206501	3/8"	1/8"	48
206502	3/8"	5/32"	48
206503	3/8"	3/16"	48
206504	3/8"	7/32"	48
206505	3/8"	1/4"	48
206507	3/8"	5/16"	48
206509	3/8"	3/8"	48



Verlängerung
Rallonge
Prolunga

Art.	○	■	L mm
207075	3/8"	3/8"	75
207150	3/8"	3/8"	150
207250	3/8"	3/8"	250



Duplex Winkel-Verlängerung
Rallonge tête angulaire duplex
Prolunga punto angolare duplex

Art.	○	■	L mm
207076	3/8"	3/8"	75
207151	3/8"	3/8"	150
207251	3/8"	3/8"	250

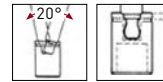

Verriegelungs-Verlängerung
Rallonge à verrouillage
Prolunga con blocco

Art.	○	■	L mm
207152	3/8"	3/8"	150
207252	3/8"	3/8"	250



Satz / Set / Set Art.123002
204



Durchgangs-Verlängerung

ermöglicht das Schrauben auf langen Bolzen und Gewindestangen.

Rallonge traversante

permet le vissage et dévissage des boulons longs et des tiges filetées.

Prolunga passanti

permette il serraggio di viti lunghe e prigionieri.



Art.	○ mm	○ mm	L mm
607075	20	20	75

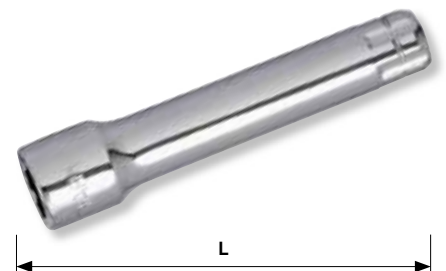

20 mm 20 mm



T-Gleitgriff-Adapter
Adaptateur pour poignée coulissante
Adattatore quadro scorrevole

Art.			L mm
208000	1/2"	3/8"	22

1/2"

3/8"





T-Griff mit Verriegelung
Clé à béquille avec verrouillage
Quadro maschio a T con blocco

Art.		L mm
212650	3/8"	650

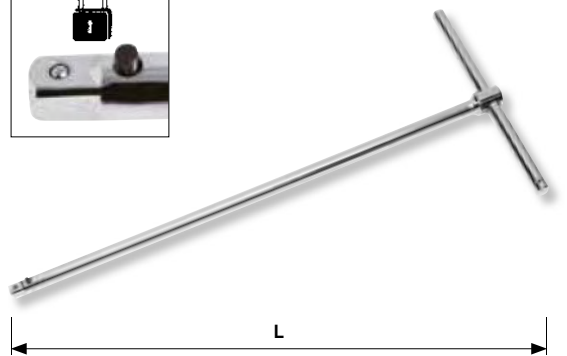
3/8"



Kardangelenk
Cardan
Snodo cardanico

Art.			L mm
210000	3/8"	3/8"	50

3/8"

3/8"



Schnellverriegelungs-Kardangelenk
Cardan avec verrouillage rapide
Adattatore universale snodato con blocco ed attacco rapido

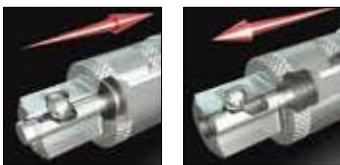

Art.			L mm
123102-38	3/8"	3/8"	79

3/8"

3/8"

Satz / Set / Set Art.123102
205



Steckschlüssel-Übergangsteil
Réducteur de douilles
Adattatore riduttore per bussola

Art.	○	■	L mm
213814	3/8"	1/4"	26



DIN 3123 / ISO 3316



Stecknuss-Adapter
zu Durchgangs-Umschaltknarre 600000

Adaptateur de douilles
pour cliquet réversible traversant 600000

Adattatore per chiavi a bussola
per chiave a cricchetto reversibile passante 600000

Art.	○	■	L mm
611140	20 mm	1/4"	28
611380	20 mm	3/8"	28



20 mm

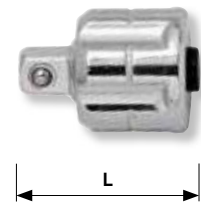

Adapter für Bits
Douille porte-embouts
Adattatore per inserti

Art.	○	○	L mm
2761	3/8"	1/4"	25

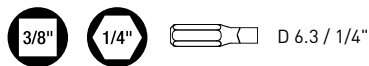

D 6.3 / 1/4"



Adapter für Bits
Douille porte-embouts
Adattatore per inserti

Art.	○	○	L mm
211516	3/8"	5/16"	29



5/16"



Steckschlüssel-Einsatz

Douille

Chiave a bussola

Art.	⊘	⊘ mm	D1 mm	D2 mm	L mm
300080	1/2"	8	22.2	13.3	38
300100	1/2"	10	22.2	15.3	38
300110	1/2"	11	22.2	16.5	38
300120	1/2"	12	22.2	17.8	38
300130	1/2"	13	22.2	19.0	38
300140	1/2"	14	22.2	20.3	38
300150	1/2"	15	22.2	21.8	38
300160	1/2"	16	22.2	22.2	38
300170	1/2"	17	23.9	23.9	38
300180	1/2"	18	24.9	24.9	38
300190	1/2"	19	24.1	25.9	38
300200	1/2"	20	24.1	27.8	38
300210	1/2"	21	24.3	27.9	38
300220	1/2"	22	26.5	29.9	38
300240	1/2"	24	26.5	31.9	38
300270	1/2"	27	29.3	35.9	40
300300	1/2"	30	33.4	39.9	43
300320	1/2"	32	34.4	41.9	43
300340	1/2"	34	35.2	43.8	43



DIN 3124 / ISO 2725-1

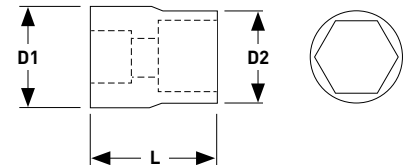

schont Schrauben und Werkzeug
ménage l'écrou et l'outil
 protegge le viti e l'utensile



Steckschlüssel-Einsatz, lang

Douille longue

Chiave a bussola tipo lungo

Art.	⊘	⊘ mm	D1 mm	D2 mm	L mm
301100	1/2"	10	22.0	15.3	77
301110	1/2"	11	22.0	16.5	77
301116	1/2"	16	22.0	22.0	77
301120	1/2"	12	22.0	17.8	77
301130	1/2"	13	22.0	19.0	77
301140	1/2"	14	22.0	20.3	77
301150	1/2"	15	22.0	22.0	77
301170	1/2"	17	23.8	23.8	77
301180	1/2"	18	25.8	25.8	77
301190	1/2"	19	25.8	25.8	77
301220	1/2"	22	29.8	29.8	77



DIN 3124 / ISO 2725-1

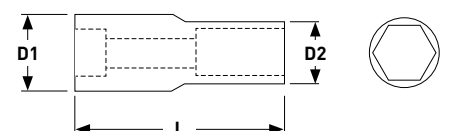

Zündkerzen-Steckschlüssel-Einsatz
Douille pour bougie
Chiave a bussola per candele



AUTOMOTIVE

Art.	⊘	⊘ mm	D mm	L mm
301160	1/2"	16	22.8	64.0
301210	1/2"	21	27.8	70.0

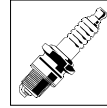

COMBI-Steckschlüssel-Einsatz
Douille COMBI multi-empreinte
Chiave a bussola COMBI



Art.	⊘	⊘ mm	⊘ inch	⊕	⊙ XZN	D1 mm	D2 mm	L mm
330100	1/2"	10	3/8"	E12	M12	21.7	15.5	38
330110	1/2"	11	7/16"	E14	M14	21.7	16.5	38
330120	1/2"	12	15/32"	E16		21.7	17.7	38
330130	1/2"	13	1/2"		M16	21.7	19.0	38
330140	1/2"	14	9/16"	E18	M18	21.9	19.9	38
330150	1/2"	15	19/32"			20.9	21.8	38
330160	1/2"	16	5/8"	E20		21.8	23.8	38
330170	1/2"	17				21.8	23.8	38
330180	1/2"	18		E22		23.9	25.6	38
330190	1/2"	19	3/4"	E24		23.9	25.8	38
330200	1/2"	20	25/32"			26.0	27.8	38
330210	1/2"	21				26.0	29.0	38
330220	1/2"	22	7/8"			26.0	30.0	38
330240	1/2"	24	15/16"			28.0	32.0	38
330270	1/2"	27	1 1/16"			30.8	35.6	42
330300	1/2"	30	1 1/8"			33.8	39.7	44
330320	1/2"	32	1 1/4"			36.0	41.8	44

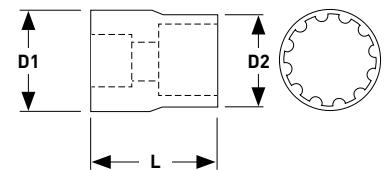
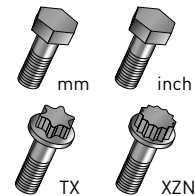

Schlag-Steckschlüssel-Einsatz
Douille impact
Chiave a bussola a macchina



Art.	Ø	Ø mm	L mm
380080	1/2"	8	38
380090	1/2"	9	38
380100	1/2"	10	38
380110	1/2"	11	38
380120	1/2"	12	38
380130	1/2"	13	38
380140	1/2"	14	38
380150	1/2"	15	38
380160	1/2"	16	38
380170	1/2"	17	38
380180	1/2"	18	38
380190	1/2"	19	38
380200	1/2"	20	38
380210	1/2"	21	38
380220	1/2"	22	38
380230	1/2"	23	38
380240	1/2"	24	38
380270	1/2"	27	38
380300	1/2"	30	38
380320	1/2"	32	38

DIN 3129 / ISO 2725-2



Schlag-Steckschlüssel-Einsatz, lang
Douille longue impact
Chiave a bussola tipo lungo a macchina

Art.	⊘	⊘ mm	L mm
381080	1/2"	8	78
381090	1/2"	9	78
381100	1/2"	10	78
381110	1/2"	11	78
381120	1/2"	12	78
381130	1/2"	13	78
381140	1/2"	14	78
381150	1/2"	15	78
381160	1/2"	16	78
381170	1/2"	17	78
381180	1/2"	18	78
381190	1/2"	19	78
381200	1/2"	20	78
381210	1/2"	21	78
381220	1/2"	22	78
381230	1/2"	23	78
381240	1/2"	24	78
381270	1/2"	27	78
381300	1/2"	30	78
381320	1/2"	32	78



DIN 3129 / ISO 2725-2

Schlag-Steckschlüssel-Einsatz, lang
mit Kunststoff-Einsatz zum Schutz der Radmutter und Kunststoff-Hülse für Alufelgen.

Douille longue impact
avec insert en matière synthétique pour protection des écrous de roue et manchon plastique pour jantes alliages.

Chiave a bussola tipo lungo a macchina
con inserto in plastica per la protezione dei dadi ruote e rivestite in plastica per cerchi in lega.

Art.	⊘	⊘ mm	colour	L mm
381150-0	1/2"	15		85
381170-0	1/2"	17		85
381190-0	1/2"	19		85
381210-0	1/2"	21		85
381220-0	1/2"	22		85
381240-0	1/2"	24		85



AUTOMOTIVE



DIN 3129 / ISO 2725-2

Durchgangs-Steckschlüssel-Einsatz

ermöglicht das Schrauben auf langen Bolzen und Gewindestangen.

Douille traversante

permet le vissage et dévissage des boulons longs et des tiges filetées.

Chiave a bussola passanti

permette il serraggio di viti lunghe e prigionieri.



30 mm

Art.	mm	mm	D1 mm	D2 mm	L mm
610190	30	19	30	24.8	42
610200	30	20	30	26.0	42
610210	30	21	30	27.0	42
610220	30	22	30	28.0	42
610240	30	24	30	31.8	42
610270	30	27	30	35.8	42
610300	30	30	30	39.8	45
610320	30	32	30	41.8	48
610340	30	34	30	43.8	50

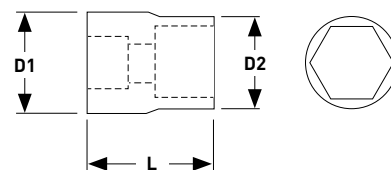

Steckschlüssel-Einsatz Aussen-TX

Douille TX femelle

Chiave a bussola TX esterno



1/2"

Art.	1/2"	E	D1 mm	D2 mm	L mm
320010	1/2"	E10	22	13	38
320012	1/2"	E12	22	15	38
320014	1/2"	E14	22	17	38
320016	1/2"	E16	22	19	38
320018	1/2"	E18	24	21	38
320020	1/2"	E20	26	23.5	38
320022	1/2"	E22	26	26	38
320024	1/2"	E24	28	28	40

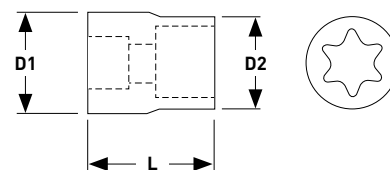

Bit-Steckschlüssel-Einsatz TX
Douille-embout TX
Chiave a bussola con inserto TX

Art.	Ø	★	L mm
325010	1/2"	T10	56
325015	1/2"	T15	56
325020	1/2"	T20	56
325025	1/2"	T25	56
325027	1/2"	T27	56
325030	1/2"	T30	56
325040	1/2"	T40	56
325045	1/2"	T45	56
325050	1/2"	T50	56
325055	1/2"	T55	56
325060	1/2"	T60	56
325070	1/2"	T70	56

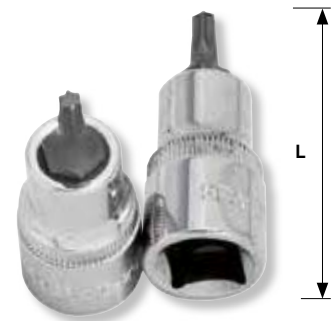

Lang-Bit-Steckschlüssel-Einsatz TX
Douille-embout TX longue
Chiave a bussola con inserto TX lungo

Art.	Ø	★	L mm
335010	1/2"	T10	100
335015	1/2"	T15	100
335020	1/2"	T20	100
335025	1/2"	T25	100
335027	1/2"	T27	100
335030	1/2"	T30	100
335040	1/2"	T40	100
335045	1/2"	T45	100
335050	1/2"	T50	100
335055	1/2"	T55	100
335060	1/2"	T60	100



Lang-Bit-Steckschlüssel-Einsatz Loch-TX
Douille-embout TX longue creuse
Chiave a bussola con inserto TX lungo con foro



Art.	Ø	☆	L mm
345330	1/2"	T30	200
345340	1/2"	T40	200
345345	1/2"	T45	200
335370	1/2"	T70	100
325380	1/2"	T80	200
325381	1/2"	T80	70

Schlag-Steckschlüssel-Einsatz TX
Douille impact TX
Chiave a bussola a macchina TX



Art.	Ø	☆	L mm
385010	1/2"	T10	78
385015	1/2"	T15	78
385020	1/2"	T20	78
385025	1/2"	T25	78
385027	1/2"	T27	78
385030	1/2"	T30	78
385040	1/2"	T40	78
385045	1/2"	T45	78
385050	1/2"	T50	78
385055	1/2"	T55	78
385060	1/2"	T60	78
385070	1/2"	T70	78
385080	1/2"	T80	78
385090	1/2"	T90	78

Bit-Steckschlüssel-Einsatz Innensechskant
Douille-embout hexagonale
Chiave a bussola con inserto esagonale



Art.	Ø	mm	L mm
326005	1/2"	5	55
326006	1/2"	6	55
326007	1/2"	7	55
326008	1/2"	8	55
326010	1/2"	10	55
326012	1/2"	12	55
326014	1/2"	14	55
326017	1/2"	17	55

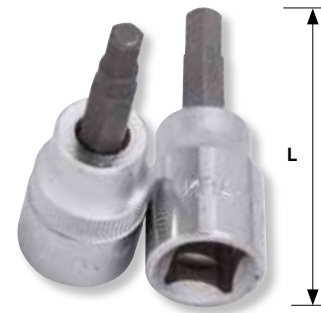

Lang-Bit-Steckschlüssel-Einsatz Innensechskant
Douille-embout longue hexagonale
Chiave a bussola con inserto esagonale lungo



Art.	Ø	mm	L mm
336005	1/2"	5	100
336006	1/2"	6	100
336007	1/2"	7	100
336008	1/2"	8	100
336010	1/2"	10	100
336012	1/2"	12	100



Schlag-Steckschlüssel-Einsatz Innensechskant
Douille impact hexagonale
Chiave a bussola a macchina esagonale



Art.	Ø	mm	L mm
386003	1/2"	3	78
386004	1/2"	4	78
386005	1/2"	5	78
386006	1/2"	6	78
386007	1/2"	7	78
386008	1/2"	8	78
386009	1/2"	9	78
386010	1/2"	10	78
386012	1/2"	12	78
386014	1/2"	14	78
386016	1/2"	16	78
386017	1/2"	17	78



Bit-Steckschlüssel-Einsatz Vielzahn XZN
Douille-embout à denture multiple XZN
Chiave a bussola con inserto XZN



Art.	Ø	XZN	L mm
328005	1/2"	M5	55
328006	1/2"	M6	55
328008	1/2"	M8	55
328010	1/2"	M10	55
328012	1/2"	M12	55
328014	1/2"	M14	55
328016	1/2"	M16	55



Lang-Bit-Steckschlüssel-Einsatz Vielzahn XZN
Douille-embout à denture multiple XZN longue
Chiave a bussola con inserto XZN lungo



Art.	Ø	XZN	L mm
338005	1/2"	M5	100
338006	1/2"	M6	100
338008	1/2"	M8	100
338010	1/2"	M10	100
338012	1/2"	M12	100



Schlag-Steckschlüssel-Einsatz Vielzahn XZN
Douille impact à denture multiple XZN
Chiave a bussola a macchina XZN



Art.	Ø	XZN	L mm
388004	1/2"	M4	78
388005	1/2"	M5	78
388006	1/2"	M6	78
388008	1/2"	M8	78
388009	1/2"	M9	78
388010	1/2"	M10	78
388012	1/2"	M12	78
388014	1/2"	M14	78
388016	1/2"	M16	78
388018	1/2"	M18	78



Bit-Steckschlüssel-Einsatz Loch-RIBE

Douille-embout RIBE creuse

Chiave a bussola con inserto RIBE con foro



Art.	Ø	⚙	L mm
329005	1/2"	RM5	55
329006	1/2"	RM6	55
329007	1/2"	RM7	55
329008	1/2"	RM8	55
329009	1/2"	RM9	55
329010	1/2"	RM10	55
329011	1/2"	RM11	55
329012	1/2"	RM12	55
329013	1/2"	RM13	55
329014	1/2"	RM14	55



Lang-Bit-Steckschlüssel-Einsatz Loch-RIBE

Douille-embout RIBE longue creuse

Chiave a bussola con inserto RIBE lungo con foro



Art.	Ø	⚙	L mm
339005	1/2"	RM5	100
339006	1/2"	RM6	100
339007	1/2"	RM7	100
339008	1/2"	RM8	100
339009	1/2"	RM9	100
339010	1/2"	RM10	100
339011	1/2"	RM11	100
339012	1/2"	RM12	100
339013	1/2"	RM13	100
339014	1/2"	RM14	100



Schlag-Steckschlüssel-Einsatz RIBE
Douille impact RIBE
Chiave a bussola a macchina RIBE



Art.	Ø	Symbol	L mm
389004	1/2"	RM4	78
389005	1/2"	RM5	78
389006	1/2"	RM6	78
389007	1/2"	RM7	78
389008	1/2"	RM8	78
389009	1/2"	RM9	78
389010	1/2"	RM10	78
389012	1/2"	RM12	78
389013	1/2"	RM13	78
389014	1/2"	RM14	78



Verlängerung
Rallonge
Prolunga

Art.	Ø	Ø	L mm
307125	1/2"	1/2"	125
307250	1/2"	1/2"	250



Duplex Winkel-Verlängerung
Rallonge tête angulaire duplex
Prolunga punto angolare duplex

Art.	Ø	Ø	L mm
307126	1/2"	1/2"	125
307251	1/2"	1/2"	250

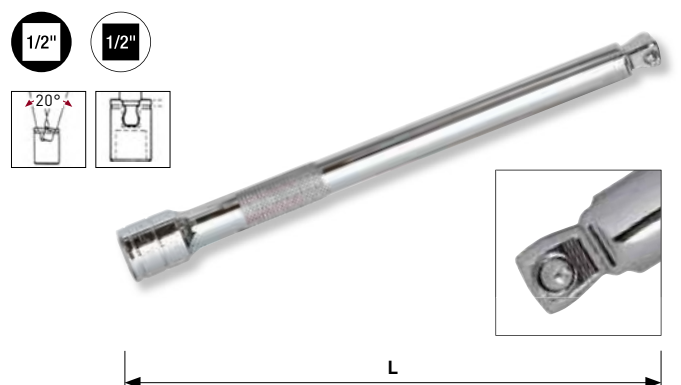

Verriegelungs-Verlängerung
Rallonge à verrouillage
Prolunga con blocco

Art.	○	■	L mm
307127	1/2"	1/2"	125
307252	1/2"	1/2"	250

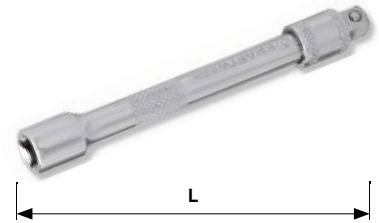
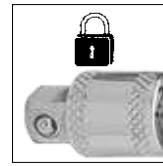

Verlängerungssatz mit Schnellverschluss-Verriegelung
Jeu de rallonges à verrouillage rapide
Set di prolungha con meccanismo di blocco rapido

Art.	○	■	L mm
123002	1/4"	1/4"	100
	3/8"	3/8"	150
	1/2"	1/2"	250



Durchgangs-Verlängerung

ermöglicht das Schrauben auf langen Bolzen und Gewindestangen.

Rallonge traversante

permet le vissage et dévissage des boulons longs et des tiges filetées.

Prolunga passanti

permette il serraggio di viti lunghe e prigionieri.

Art.	○	⊗ mm	L mm
617075	30	30	75
617150	30	30	150



30 mm

30 mm

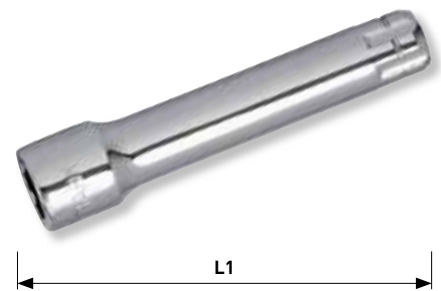

Schlag-Verlängerung

Rallonge impact

Prolunga per bussola a macchina



Art.	○	■	L mm
387125	1/2"	1/2"	125



T-Gleitgriff-Adapter

Adaptateur pour poignée coulissante

Quadro scorrevole

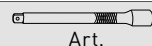
Art.			 Art.	L mm
308000	3/8"	1/2"	307250	43.5
308001	3/8"	1/2"	307251	43.5

3/8"

1/2"



Kardangelenk

Cardan

Snodo cardanico

Art.			L mm
310000	1/2"	1/2"	75

1/2"

1/2"

DIN 3123 / ISO 3316





Schnellverriegelungs-Kardangelenk

Cardan avec verrouillage à changement rapide

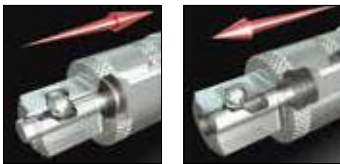
Adattatore universale snodato con blocco ed attacco rapido



Art.			L mm
123102-12	1/2"	1/2"	79

1/2"

1/2"





Satz mit Schnellverschluss-/Verriegelungs-Kardangelenken

Jeu de cardans à verrouillage et changement rapide

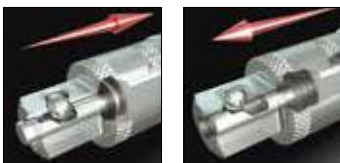
Set di adattatori universali snodati con blocco e attacco rápido



Art.			L mm
123102	1/4"	1/4"	55
	3/8"	3/8"	79
	1/2"	1/2"	110

1/4"

3/8"

1/2"

CrV

3
PCS

1/4"

3/8"

1/2"



Schlag-Kardangelen
Cardan impact
Snodo cardanico a macchina

Art.	○	■	L mm
381000	1/2"	1/2"	65



DIN 3123 / ISO 3316

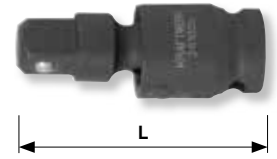

Schlag-Kardangelen-Satz
Jeu de cardans impact
Set snodi caradanico a macchina

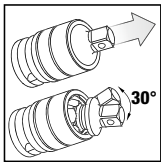

Art.	○	■	L mm
387998	1/4"	1/4"	37
	3/8"	3/8"	46
	1/2"	1/2"	62

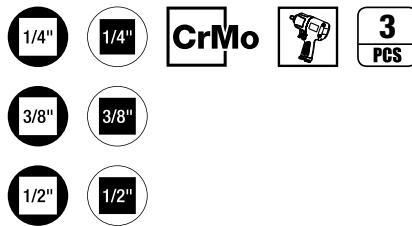

**Satz Schlag-Stecknuss-Übergangs-/
Reduktions-Adapter**
Jeu d'adaptateurs/réducteurs impact à cardan
Set di adattatori e riduttori snodati a macchina

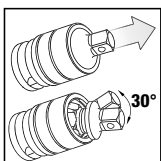

Art.	○	■	L mm
387999	1/4"	3/8"	36
	3/8"	1/4"	44
	3/8"	1/2"	48
	1/2"	3/8"	57
	1/2"	3/4"	70

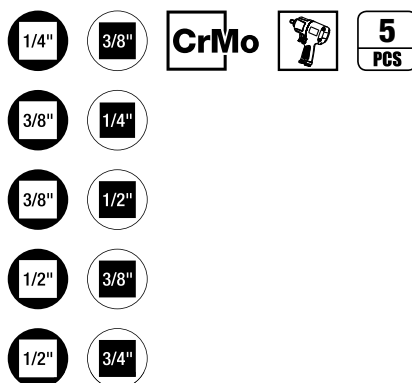

Übergangsstück
Augmentateur
Raccordo aumentatore

Art.	○	■	L mm
311340	1/2"	3/4"	46



DIN 3123 / ISO 3316



Reduktionsstück
Réducteur
Raccordo riduttore

Art.	○	■	L mm
311380	1/2"	3/8"	37

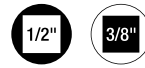

DIN 3123 / ISO 3316



Schlag-Übergangsstück
Augmentateur impact
Raccordo aumentatore a macchina

Art.	○	■	L mm
381340	1/2"	3/4"	48



DIN 3121 / ISO 1174



Adapter für Bits
Douille porte-embouts
Adattatore per inserti

Art.	○	○	L mm
311516	1/2"	5/16"	38



Schlag-Adapter für Bits
Douille porte-embouts impact
Adattatore per inserti a macchina

Art.	○	○	L mm
381516	1/2"	5/16"	39



DIN 7427-A



Stecknuss-Adapter



zu Durchgangs-Umschaltknarre 610000

Adaptateur de douilles

pour cliquet réversible traversant 610000

Adattatore per chiavi a bussola

per chiave a cricchetto reversibile passante 610000

Art.			L mm
611120	1/2"	30 mm	40

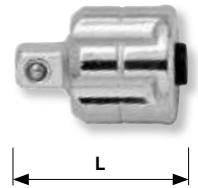

Schlag-Stecknuss-Adapter

mit Verriegelung



Adaptateur de douilles impact

à verrouillage

Adattatore per bussole a macchina

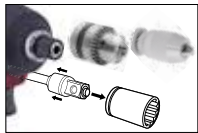
con blocco



Art.			L mm
381014	1/4"	1/4"	75
381038	1/4"	3/8"	75
381012	1/4"	1/2"	75
381003	1/4"	Satz / Jeu / Assortimento 1/4" + 3/8" + 1/2"	75

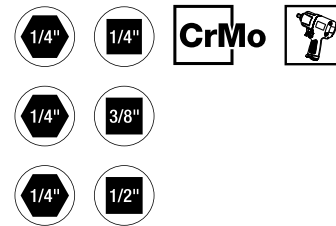

Schlag-Stecknuss-Adapter

mit Verriegelung



Adaptateur de douilles impact

à verrouillage

Adattatore per bussole a macchina

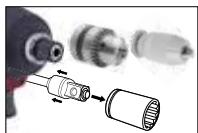
con blocco



Art.			L mm
381114	1/4"	1/4"	150
381138	1/4"	3/8"	150
381112	1/4"	1/2"	150
381103	1/4"	Satz / Jeu / Assortimento 1/4" + 3/8" + 1/2"	150

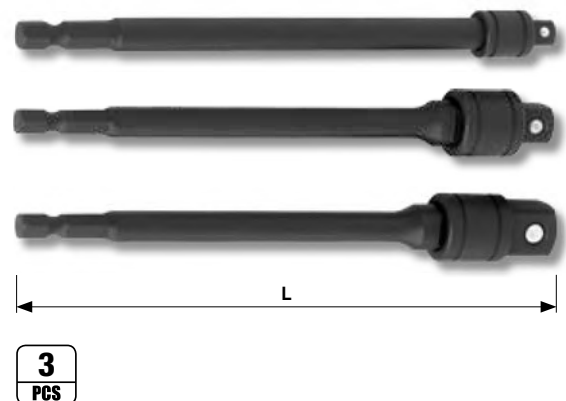
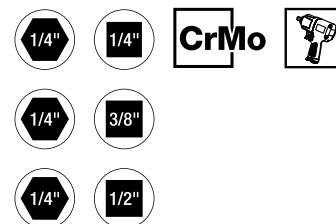

Schmalprofil-Übergangstück-Satz

mit speziell flachem Profil

Jeu d'augmentateurs

extra-plats

Serie di raccordi aumentatore

con profilo extra sottile



Art.	○	■	L1 mm	L2 mm
123003	1/4"	3/8"	18	6.5
	3/8"	1/2"	23	7.5
	1/2"	3/4"	34.5	11.5

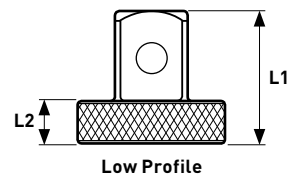

Steckschlüssel-Einsatz

Douille

Chiave a bussola



Art.	○	○ mm	D1 mm	D2 mm	L mm
400190	3/4"	19	33.0	29.0	50
400210	3/4"	21	33.0	31.0	50
400220	3/4"	22	36.0	32.0	50
400230	3/4"	23	36.0	33.0	50
400240	3/4"	24	36.0	34.0	51
400260	3/4"	26	38.0	36.0	52
400270	3/4"	27	36.0	38.0	52
400290	3/4"	29	38.0	40.0	52
400300	3/4"	30	38.0	42.0	54
400320	3/4"	32	38.0	44.0	56
400350	3/4"	35	42.0	48.0	58
400360	3/4"	36	42.0	50.0	58
400380	3/4"	38	45.0	52.0	60
400410	3/4"	41	45.0	56.0	64
400460	3/4"	46	47.0	62.0	68
400500	3/4"	50	48.0	68.0	72



DIN 3124 / ISO 2725-1

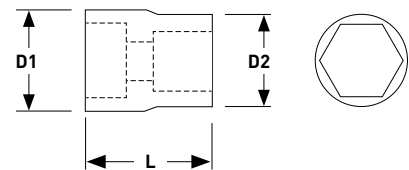

Schlag-Steckschlüssel-Einsatz
Douille impact
Chiave a bussola a macchina



Art.	⊙	⊙ mm	L mm
480170	3/4"	17	50
480190	3/4"	19	52
480200	3/4"	20	52
480210	3/4"	21	52
480220	3/4"	22	52
480230	3/4"	23	52
480240	3/4"	24	52
480250	3/4"	25	52
480260	3/4"	26	52
480270	3/4"	27	52
480280	3/4"	28	52
480290	3/4"	29	52
480300	3/4"	30	52
480320	3/4"	32	52
480330	3/4"	33	56
480340	3/4"	34	56
480350	3/4"	35	56
480360	3/4"	36	56
480380	3/4"	38	56
480410	3/4"	41	58
480460	3/4"	46	63
480500	3/4"	50	72



Schlag-Steckschlüssel-Einsatz, lang
Douille longue impact
Chiave a bussola tipo lungo a macchina



Art.	Ø	Ø mm	L mm
481170	3/4"	17	90
481180	3/4"	18	90
481190	3/4"	19	90
481210	3/4"	21	90
481220	3/4"	22	90
481240	3/4"	24	90
481260	3/4"	26	90
481270	3/4"	27	90
481290	3/4"	29	90
481300	3/4"	30	90
481320	3/4"	32	90
481350	3/4"	35	90
481360	3/4"	36	90
481380	3/4"	38	92
481410	3/4"	41	92
481460	3/4"	46	92
481500	3/4"	50	95



Verlängerung
Rallonge
Prolunga

Art.	○	■	L mm
407100	3/4"	3/4"	100
407200	3/4"	3/4"	200
407400	3/4"	3/4"	400



Verriegelungs-Verlängerung
Rallonge à verrouillage
Prolunga con blocco

Art.	○	■	L mm
407102	3/4"	3/4"	100
407202	3/4"	3/4"	200
407402	3/4"	3/4"	400



Schlag-Verlängerung
Rallonge impact
Prolunga per bussola a macchina

Art.	○	■	L mm
487100	3/4"	3/4"	100
487200	3/4"	3/4"	200



CrMo



Gleitgriff
Poignée coulissante
Quadro maschio con spina scorrevole

Art.	■	L mm
408000	3/4"	460



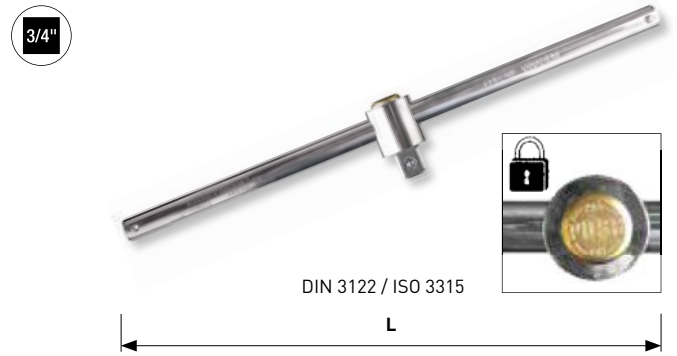

Verriegelungs-Gleitgriff
Poignée coulissante à verrouillage
Quadro maschio con spina scorrevole con blocco

Art.		L mm
408002	3/4"	460





Schlag-Kardangelenk
Cardan impact
Snodo cardanico a macchina

Art.			L mm
481000	3/4"	3/4"	90



Übergangsstück
Augmentateur
Raccordo aumentatore

Art.			L mm
411120	3/4"	1"	56





Reduktionsstück
Réducteur
Raccordo riduttore

Art.			L mm
411100	3/4"	1/2"	56



Schlag-Übergangsstück
Augmentateur impact
Raccordo aumentatore a macchina

Art.			L mm
483410	3/4"	1"	64



Schlag-Reduktionsstück

Réducteur impact

Raccordo riduttore a macchina

Art.	○	■	L mm
483412	3/4"	1/2"	56



Steckschlüssel-Einsatz

Douille

Chiave a bussola

Art.	○	○ mm	D1 mm	D2 mm	L mm
500360	1"	36	45	51	65
500380	1"	38	45	54	65
500410	1"	41	45	57	70
500460	1"	46	50	65	75
500500	1"	50	55	70	75
500540	1"	54	57	74	80
500550	1"	55	57	76	80
500580	1"	58	57	79	80
500600	1"	60	57	82	84
500630	1"	63	57	86	87
500650	1"	65	57	88	87
500670	1"	67	57	90	90
500700	1"	70	68	94	93
500710	1"	71	68	95	93
500750	1"	75	68	100	97
500770	1"	77	68	102	103
500800	1"	80	68	105	103

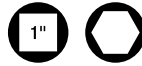

DIN 3124 / ISO 2725-1

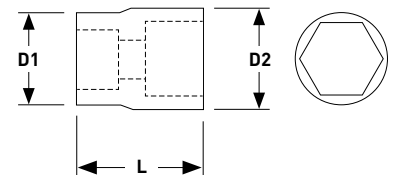

Schlag-Steckschlüssel-Einsatz, lang
Douille longue impact
Chiave a bussola tipo lungo a macchina



Art.	⊙	⊙ mm	L mm
581220	1"	22	90
581240	1"	24	90
581270	1"	27	90
581300	1"	30	90
581320	1"	32	90
581330	1"	33	90
581340	1"	34	90
581360	1"	36	90
581380	1"	38	92
581410	1"	41	92
581460	1"	46	92
581500	1"	50	95
581550	1"	55	100
581600	1"	60	105
581650	1"	65	120
581700	1"	70	124
581750	1"	75	135
581800	1"	80	135
581850	1"	85	140
581900	1"	90	140



Verlängerung
Rallonge
Prolunga

Art.	○	■	L mm
507200	1"	1"	200
507400	1"	1"	400



Schlag-Verlängerung
Rallonge impact
Prolunga per bussola a macchina

Art.	○	■	L mm
587200	1"	1"	200



T-Gleitgriff-Adapter
Adaptateur pour poignée coulissante
Quadro scorrevole

Art.	○	■	L mm
508000	1"	1"	74

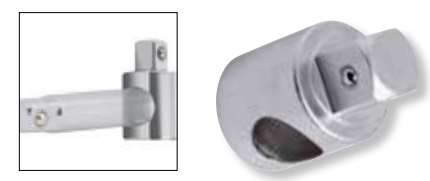

Schlag-Kardangelen
Cardan impact
Snodo cardanico a macchina

Art.	○	■	L mm
581000	1"	1"	110



Reduktionsstück
Réducteur
Raccordo riduttore

Art.	○	■	L mm
511340	1"	3/4"	70



DIN 3123 / ISO 3316

Schlag-Reduktionsstück
Réducteur impact
Raccordo riduttore a macchina

Art.	○	■	L mm
581034	1"	3/4"	75





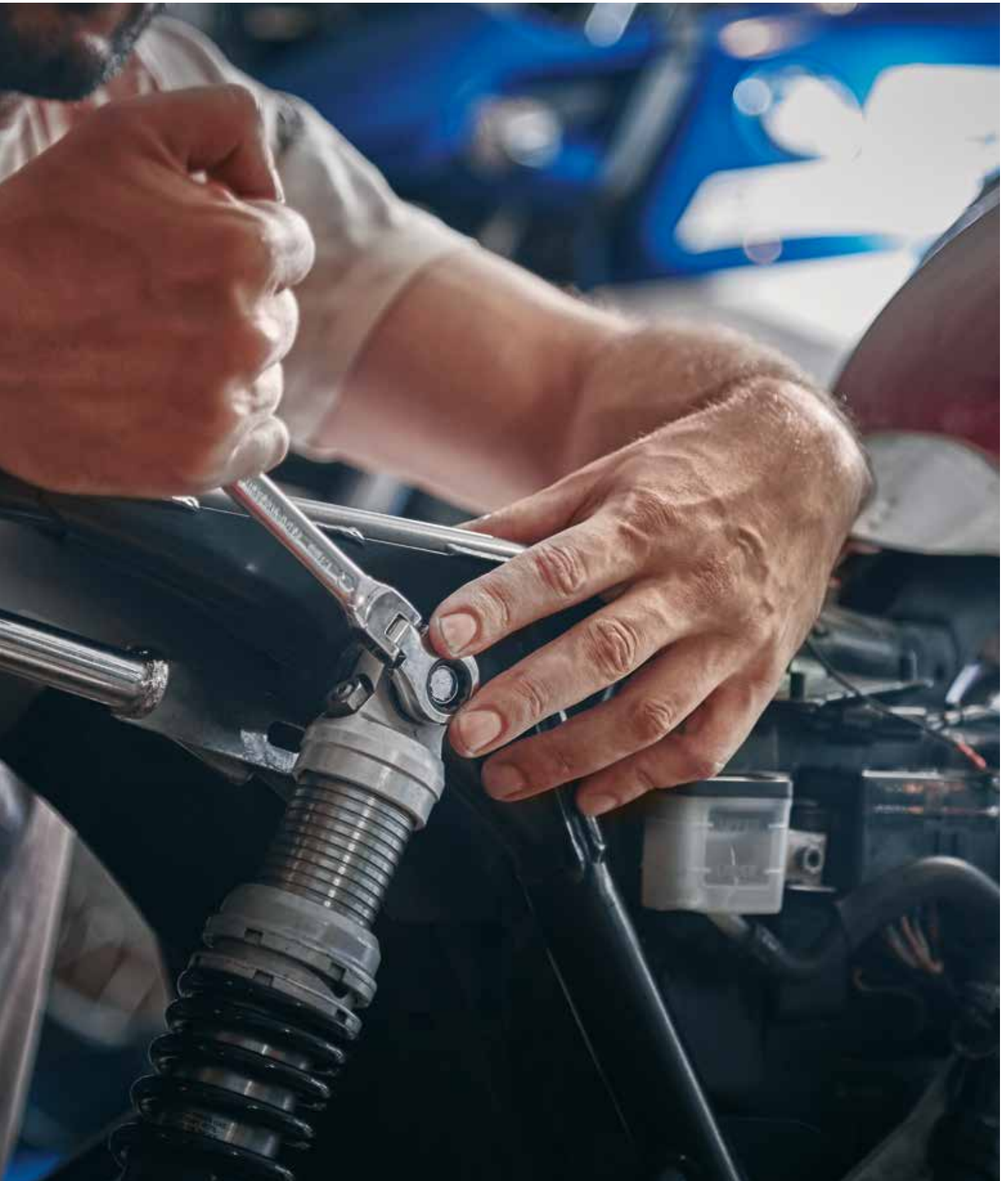



75
19 mm
3/4"

72

60
8-9 mm
3/16-5/16"

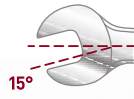
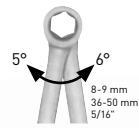

CLICKRAFT

DOUBLE RATCHET

COMBINATION

XXL LARGO

XXL LARGO 90

DOUBLE RING

REVERSIBLE

QUAD REVERSIBLE

FLEX

STUBBY FLEX

DOUBLE FLEX

ANGLE



DOUBLE RATCHET CLICKRAFT

Doppel-Ratschen-Ringgabelschlüssel

gerade, mit zusätzlicher Ratschenfunktion in der Gabel

Clé combinée à cliquet double

plate, avec mécanisme de cliquet supplémentaire intégré dans la fourche

Chiave combinata a doppio cricchetto

con funzione di cricchetto anche nella parte della forchetta

Art.	Ø mm	D mm	L mm	Ø
3401-08	8	17.7	140	60
3401-09	9	19.0	149	60
3401-10	10	21.1	159	72
3401-11	11	23.1	165	72
3401-12	12	24.5	172	72
3401-13	13	26.5	178	72
3401-14	14	27.9	190	72
3401-15	15	30.5	199	72
3401-16	16	32.4	208	72
3401-17	17	34.2	225	72
3401-18	18	35.3	236	72
3401-19	19	36.1	248	75
3401-20	20	42.3	270	72
3401-21	21	42.3	270	72
3401-22	22	42.3	291	72
3401-24	24	49.3	312	72

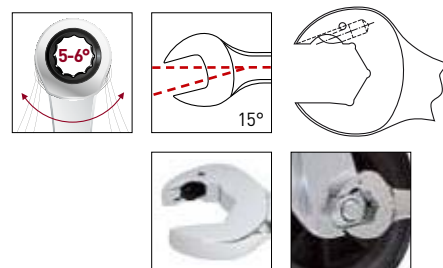
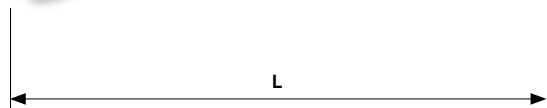

Doppel-Ratschen-Ringgabelschlüssel-Satz

gerade, mit zusätzlicher Ratschenfunktion in der Gabel

Jeu de clés combinées à cliquet double

plates, avec mécanisme de cliquet supplémentaire intégré dans la fourche

Assortimento di chiavi combinate a doppio cricchetto

con funzione di cricchetto anche nella parte della forchetta

Art.	Ø mm
3401-50	10-13-17-19

4
PCS



Doppel-Ratschen-Ringgabelschlüssel-Satz

gerade, mit zusätzlicher Ratschenfunktion in der Gabel

Jeu de clés combinées à cliquet double

plates, avec mécanisme de cliquet supplémentaire intégré dans la fourche

Assortimento di chiavi combinate a doppio cricchetto

con funzione di cricchetto anche nella parte della forchetta

Art.	mm
3401-54	8-9-10-11-12-13-14-15-16-17-18-19

12
PCS



↕ 325 x 185 x 56 mm

Doppel-Ratschen-Ringgabelschlüssel-Koffer

gerade, mit zusätzlicher Ratschenfunktion in der Gabel (ausser 5.5-6-7 mm)

Coffret de clés combinées à cliquet double

plates, avec mécanisme de cliquet supplémentaire intégré dans la fourche (sauf 5.5-6-7 mm)

Valigetta di chiavi combinate a doppio cricchetto

diritte, con funzione di cricchetto anche nella parte della forchetta (ecchetto 5.5-6-7 mm)

*Optional / Optionnel / Opzionali



Art. 3691 ■ 1/4" x ● 10 mm

Art. 3692 ■ 3/8" x ● 13 mm

Art. 3693 ■ 1/2" x ● 19 mm



Art. 2694 ○ 1/4" x ● 10 mm



Art.	mm
4900-40K	5.5-6-7-8-9-10-11-12-13-14-15-16-17-18-19

15
PCS

COMPLETO



↕ 421 x 200 x 68 mm

Ratschen-Ringgabelschlüssel

gerade

Clé combinée à cliquet

plate

Chiave combinata a cricchetto

diritta

Art.	○ mm	D mm	L mm	○
3405	5.5	16.5	125	60
3406	6	17.0	125	60
3407	7	17.0	140	60
3408	8	17.0	140	60
3409	9	18.5	149	60
3410	10	20.5	160	72
3411	11	21.5	165	72
3412	12	23.0	170	72
3413	13	25.0	180	72
3414	14	28.0	190	72
3415	15	29.0	200	72
3416	16	30.0	210	72
3417	17	31.5	225	72
3418	18	33.0	235	72
3419	19	34.0	250	75
3420	20	41.0	290	72
3421	21	41.0	290	72
3422	22	41.5	290	72
3424	24	48.0	333	72
3427M	27	52.5	360	72
3430M	30	59.0	400	72
3432M	32	62.5	425	72
3434M	34	63.0	460	72
3436M	36	64.0	500	60
3441M	41	68.0	575	60
3446M	46	76.0	645	60
3450M	50	80.0	655	60

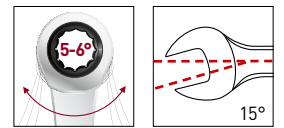
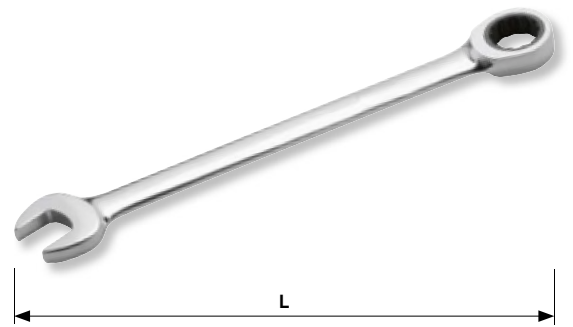

Ratschen-Ringgabelschlüssel-Satz

gerade

Jeu de clés combinées à cliquet

plates

Assortimento di chiavi combinate a cricchetto

diritte

Art.	○ mm
3400-50	10-13-17-19

4
PCS



Ratschen-Ringgabelschlüssel-Satz

gerade

Jeu de clés combinées à cliquet

plates

Assortimento di chiavi combinate a cricchetto

diritte

Art.	○ mm
3427	8-10-12-13-17-19

6
PCS



Ratschen-Ringgabelschlüssel-Satz

gerade

Coffret de clés combinées à cliquet

plates

Assortimento di chiavi combinate a cricchetto

diritte

Art.	○ mm
3400-54	8-9-10-11-12-13-14-15-16-17-18-19

12
PCS



↕ 325 x 185 x 56 mm

COMBINATION CLICKRAFT

COMPLETO

19
PCS



421 x 200 x 68 mm

Ratschen-Ringgabelschlüssel-Koffer

gerade, mit Steckschlüssel- und Bit-Adaptorn

Coffret de clés combinées à cliquet

plates, avec adaptateurs de douilles et embouts

Valigetta di chiavi combinate a cricchetto

diritte, con adattatori per bussole ed inserti

* inklusiv / inclus / incluso



Art. 3691 1/4" x 10 mm

Art. 3692 3/8" x 13 mm

Art. 3693 1/2" x 19 mm



Art. 2694 1/4" x 10 mm



Art.	mm
4900-17K	5.5-6-7-8-9-10-11-12-13-14-15-16-17-18-19

Ratschen-Ringgabelschlüssel Zollmasse

gerade

Clé combinée à cliquet en pouce

plate

Chiave combinata a cricchetto in pollici

diritta

Art.	inch	D mm	L mm	mm
3431	5/16"	17.0	140	60
3432	3/8"	20.5	160	72
3433	7/16"	21.2	165	72
3434	1/2"	25.5	180	72
3435	9/16"	28.0	190	72
3436	5/8"	30.0	210	72
3437	11/16"	31.5	225	72
3438	3/4"	34.0	250	75

inch

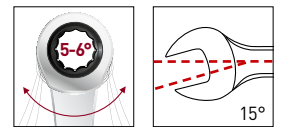
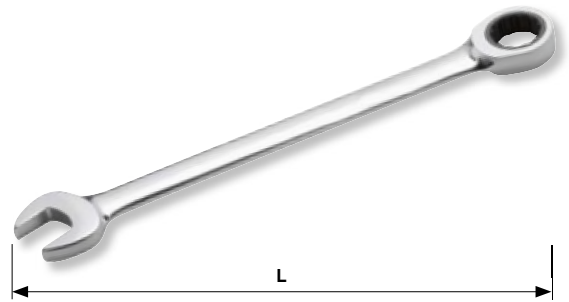

Ratschen-Ringgabelschlüssel-Satz Zollmasse

gerade

Jeu de clés combinées à cliquet en pouce

plates

Assortimento di chiavi combinate a cricchetto in pollici

diritte

Art.	inch
3430	5/16"-3/8"-7/16"-1/2"-9/16"-5/8"-11/16"-3/4"

8
PCS

inch



Ratschen-Ringgabelschlüssel

gerade, extra lang

Clé combinée à cliquet

plate, extra longue

Chiave combinata a cricchetto

diritta, extra lunga

XXL

Art.	Ø mm	D mm	L mm	○
4402-08	8	17.5	150	60
4402-09	9	18.3	165	60
4402-11	11	22.3	195	72
4402-12	12	24.0	207	72
4402-14	14	28.2	235	72
4402-15	15	30.2	250	72
4402-16	16	32.0	260	72
4402-17	17	32.8	275	72
4402-18	18	33.6	290	72
4402-19	19	36.4	305	75
4402-20	20	41.2	318	72
4402-21	21	41.2	318	72
4402-22	22	41.2	330	72
4402-24	24	46.7	356	72

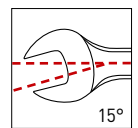
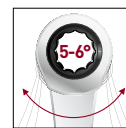

LARGO



STANDARD

LARGO

+22%

STANDARD



XXL

Ratschen-Ringgabelschlüssel-Satz

gerade, extra lang

Jeu de clés combinées à cliquet

plates, extra longues

Assortimento di chiavi combinate a cricchetto

diritte, extra lunghe

*Optional / Optionnel / Opzionali



Art. 3691 1/4" x 10 mm

Art. 3692 3/8" x 13 mm

Art. 3693 1/2" x 19 mm



Art. 2694 1/4" x 10 mm



Art.	mm
4402-51	8-10-13-17-19

5
PCS



380 x 212 x 55 mm

Ratschen-Ringgabelschlüssel-Satz

gerade, extra lang

Jeu de clés combinées à cliquet

plates, extra longues

Assortimento di chiavi combinate a cricchetto

diritte, extra lunghe

*Optional / Optionnel / Opzionali



Art. 3691 1/4" x 10 mm

Art. 3692 3/8" x 13 mm

Art. 3693 1/2" x 19 mm



Art. 2694 1/4" x 10 mm



Art.	mm
4402-52	8-10-11-12-13-16-17-18-19

9
PCS



380 x 212 x 55 mm

Ratschen-Ringgabelschlüssel-Satz

gerade, extra lang

Jeu de clés combinées à cliquet

plates, extra longues

Assortimento di chiavi combinate a cricchetto

diritte, extra lunghe

*Optional / Optionnel / Opzionali



Art. 3691 1/4" x 10 mm

Art. 3692 3/8" x 13 mm

Art. 3693 1/2" x 19 mm



Art. 2694 1/4" x 10 mm



Art.	mm
4402-53	8-9-10-11-12-13-14-15-16-17-18-19

12
PCS



380 x 212 x 55 mm

LARGO 90 Ratschen-Ringgabelschlüssel

500 % mehr Auflage-/Druckfläche dank der 90° Querschmiedung des LARGO 90-Schlüssels. Gabel- und Ringseitiges Arbeiten ohne Druckstellen in den Händen, da mit der Fläche und nicht wie bei herkömmlichen Schlüsseln mit der schmalen Kante gearbeitet wird.

Clé combinée à cliquet LARGO 90

500 % de surface de contact supplémentaire grâce à la partie plane de la nouvelle clé LARGO 90. La pression s'exerce sur la surface plate et non plus sur la tranche étroite de la clé ce qui permet de travailler en respectant totalement et parfaitement l'ergonomie de la main.

Chiave combinata a cricchetto LARGO 90

500% di superficie di contatto in più grazie alla forma delle due imboccature ruotate di 90° della nuova chiave LARGO 90. Sia sul lato della forchetta aperta che su quello dell'occhio chiuso, la forza viene esercitata sulla superficie piana della chiave e non più sul taglio della chiave stessa.

Art.	Ø mm	D mm	L mm	Ø
4405-08	8	17.5	148	60
4405-09	9	18.3	163	60
4405-10	10	21.3	179	72
4405-11	11	22.3	193	72
4405-12	12	24.0	204	72
4405-13	13	26.3	219	72
4405-14	14	28.2	234	72
4405-15	15	30.2	248	72
4405-16	16	32.0	259	72
4405-17	17	32.8	274	72
4405-18	18	33.6	291	72
4405-19	19	36.4	305	75

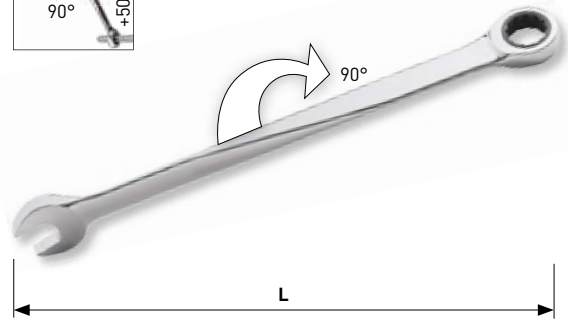
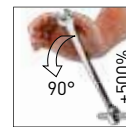

LARGO 90 Ratschen-Ringgabelschlüssel-Koffer

500 % mehr Auflage-/Druckfläche dank der 90° Querschmiedung des Schlüssels

Coffret de clés combinées à cliquet LARGO 90

500 % de surface de contact supplémentaire grâce au forgeage transversal de la clé

Valigetta di chiavi combinate a cricchetto LARGO 90

500% di superficie di contatto in più grazie alla forma delle due imboccature ruotate di 90° della chiave

Art.	Ø mm
4900-28K	8-9-10-11-12-13-14-15-16-17-18-19

12
PCS

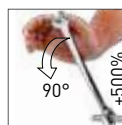

COMPLETO



421 x 200 x 68 mm

DOUBLE RING CLICKRAFT

Ratschen-Doppelringschlüssel

gerade

Clé polygonale à cliquet

plate

Chiave poligonale doppia a cricchetto

diritta

Art.	○ mm	L mm	○
3441	8 x 9	130	60
3440	8 x 10	128	60 x 72
3442	10 x 11	150	72
3447	10 x 13	160	72
3443	12 x 13	170	72
3444	14 x 15	187	72
3445	16 x 18	210	72
3446	17 x 19	230	72 x 75

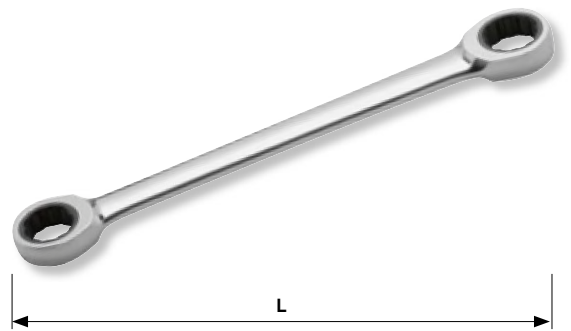

Ratschen-Doppelringschlüssel Aussen-TX

gerade

Clé à cliquet double TX extérieur

plate

Chiave doppia a cricchetto TX esterno

diritta

Art.	⊕	L mm	○
3471	E6 x E8	130	60
3472	E10 x E12	150	60
3473	E14 x E18	190	60
3474	E20 x E24	230	60

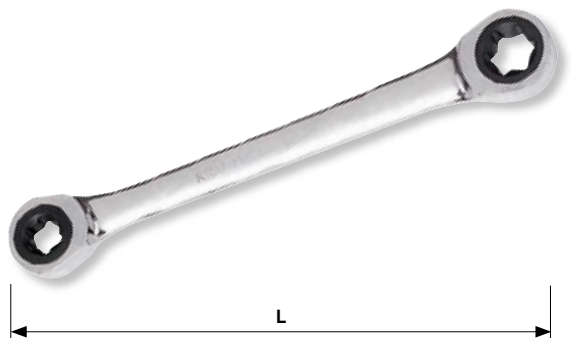

Ratschen-Ringgabelschlüssel

umschaltbar

Clé combinée à cliquet

réversible

Chiave combinata a cricchetto

reversibile

Art.	Ø mm	D mm	L mm	Ø
3404-08	8	16.8	140	60
3404-09	9	18.2	149	60
3404-10	10	20.1	159	72
3404-11	11	21.5	165	72
3404-12	12	23.0	170	72
3404-13	13	25.1	180	72
3404-14	14	27.1	190	72
3404-15	15	29.0	200	72
3404-16	16	30.6	208	72
3404-17	17	31.8	225	72
3404-18	18	32.3	236	72
3404-19	19	34.1	248	75
3404-20	20	41.7	290	72
3404-21	21	41.7	290	72
3404-22	22	41.7	290	72
3404-24	24	48.0	330	72

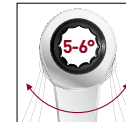
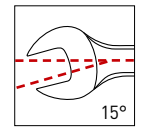
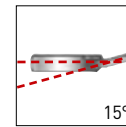
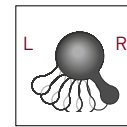
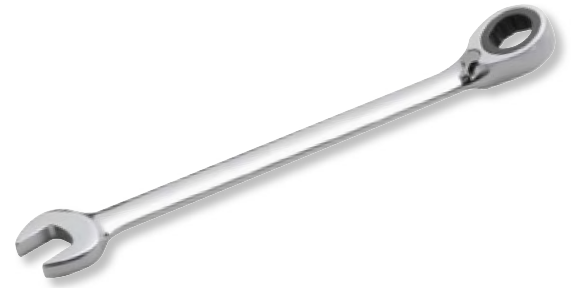

REVERSIBLE CLICKRAFT

Ratschen-Ringgabelschlüssel-Satz

umschaltbar

Jeu de clés combinées à cliquet

réversible

Assortimento di chiavi combinate a cricchetto

reversibili

Art.	mm
3404-50	10-13-17-19

4
PCS



Ratschen-Ringgabelschlüssel-Satz

umschaltbar

Jeu de clés combinées à cliquet

réversible

Assortimento di chiavi combinate a cricchetto

reversibili

Art.	mm
3404-51	8-10-12-13-17-19

6
PCS



Ratschen-Ringgabelschlüssel-Satz

umschaltbar

Jeu de clés combinées à cliquet

réversible

Assortimento di chiavi combinate a cricchetto

reversibili

Art.	mm
3404-54	8-9-10-11-12-13-14-15-16-17-18-19

12
PCS



↕ 325 x 185 x 56 mm

Ratschen-Ringgabelschlüssel-Koffer

umschaltbar

Coffret de clés combinées à cliquet

réversible

Valigetta di chiavi combinate a cricchetto

reversibili

14
PCS



COMPLETO



421 x 200 x 68 mm

Art.	mm
4900-47K	8-9-10-11-12-13-14-15-16-17-18-19-22-24

4-in-1 Ratschen-Doppelringschlüssel

umschaltbar

Clé polygonale à cliquet 4-en-1

réversible

Chiave poligonale doppia a cricchetto 4-in-1

reversibile

Art.	mm	L mm	mm
3404-0813	8 x 10 mm 12 x 13 mm	160	72 x 72
3404-1019	10 x 13 mm 17 x 19 mm	200	72 x 75
3404-1619	16 x 17 mm 18 x 19 mm	230	72 x 75
3404-51612	5/16" x 3/8" 7/16" x 1/2"	160	72 x 72
3404-91634	9/16" x 5/8" 11/16" x 3/4"	210	72 x 75

QUAD REVERSIBLE CLICKRAFT



4in1

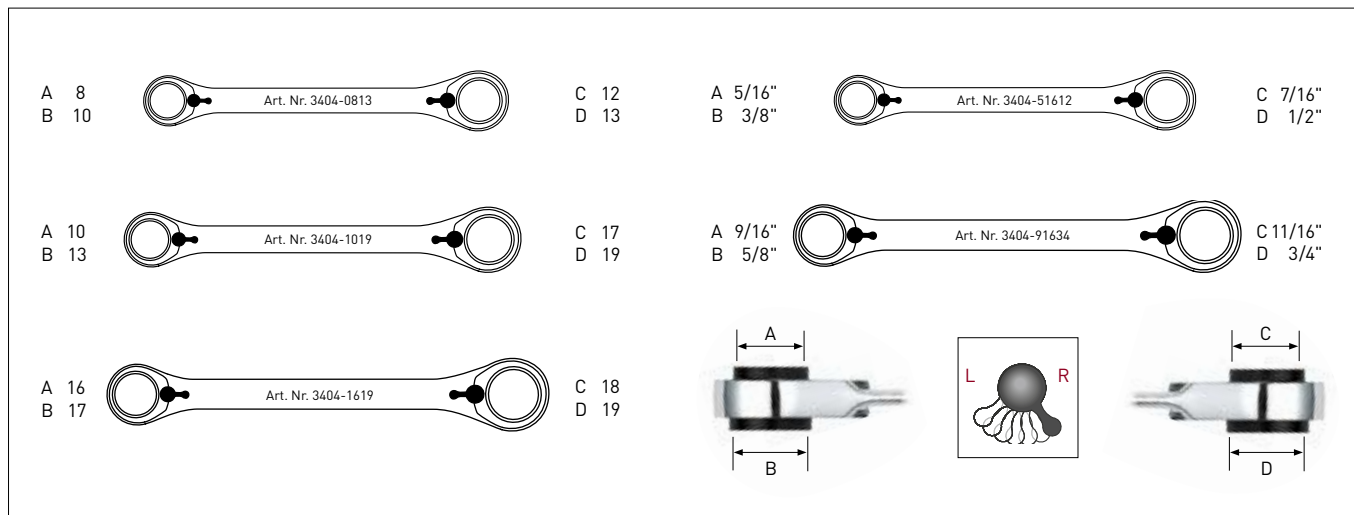

QUAD REVERSIBLE CLICKRAFT

4-in-1 Ratschen-Doppelringschlüssel-Satz

umschaltbar

Jeu de clés polygonales à cliquet 4-en-1

réversible

Assortimento di chiavi poligonali doppie a cricchetto 4-in-1

reversibili

2
PCS



↕ 250 x 110 x 35 mm

Art.	○ mm
3404-4x2	8 x 10 / 12 x 13 16 x 17 / 18 x 19

Ratschen-Ringgabelschlüssel

flexibel

Clé combinée à cliquet

articulée

Chiave combinata a cricchetto

snodata

Art.	○ mm	D mm	L mm	○
3403-08	8	17.0	140	60
3403-09	9	19.0	149	60
3403-10	10	20.0	158	72
3403-11	11	22.0	165	72
3403-12	12	23.0	171	72
3403-13	13	25.0	176	72
3403-14	14	27.5	190	72
3403-15	15	29.0	199	72
3403-16	16	30.0	208	72
3403-17	17	32.0	225	72
3403-18	18	34.0	236	72
3403-19	19	34.3	248	75
3403-20	20	42.0	290	72
3403-21	21	42.0	290	72
3403-22	22	42.0	290	72
3403-24	24	49.0	333	72

FLEX CLICKRAFT

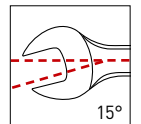
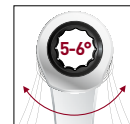
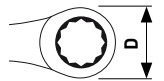
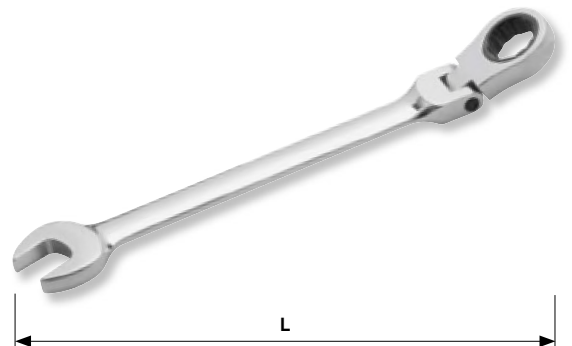

Ratschen-Ringgabelschlüssel-Satz

flexibel

Jeu de clés combinées à cliquet

articulées

Assortimento di chiavi combinate a cricchetto

snodate

Art.	○ mm
3403-51	8-10-12-13-17-19

6
PCS



Ratschen-Ringgabelschlüssel-Satz

flexibel

Jeu de clés combinées à cliquet

articulées

Assortimento di chiavi combinate a cricchetto

snodate

Art.	○ mm
3403-54	8-9-10-11-12-13-14-15-16-17-18-19

12
PCS



↕ 325 x 185 x 56 mm

Ratschen-Ringgabelschlüssel-Koffer

flexibel

Coffret de clés combinées à cliquet

articulées

Valigetta di chiavi combinate a cricchetto

snodate

Art.	○ mm
4900-46K	8-9-10-11-12-13-14-15-16-17-18-19-22-24

14
PCS



COMPLETO



↕ 421 x 200 x 68 mm

Ratschen-Ringgabelschlüssel

flexibel, extra kurz

Clé combinée à cliquet

articulée, courte

Chiave combinata a cricchetto

snodata, corta

Art.	Ø mm	D mm	L mm	Ø
3403-08S	8	17.0	88	60
3403-10S	10	20.0	94	72
3403-11S	11	22.0	102	72
3403-12S	12	23.0	105	72
3403-13S	13	25.0	107	72
3403-14S	14	27.5	114	72

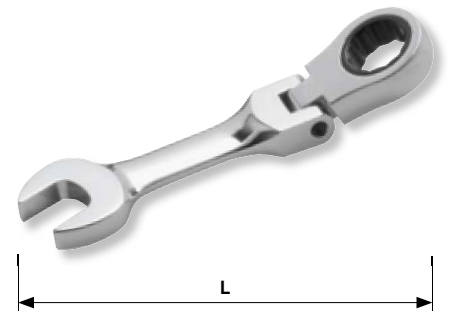

Ratschen-Ringgabelschlüssel

seitlich abwinkelbar, stufenlos bis zu 180° zum Ratschen auch an schwer zugänglichen Stellen. Arretierungsknopf zur Fixierung des Winkels

Clé combinée à cliquet

avec renvoi d'angle par degrés jusqu'à 180° pour intervenir dans les endroits les plus inaccessibles. Bouton d'arrêt pour fixer l'angle désiré

Chiave combinata a cricchetto

orientabile a regolazione continua fino a 180° per l'utilizzo del cricchetto anche in spazi normalmente inaccessibili. Pulsante di blocco per il bloccaggio con angolazione predefinita

Art.	Ø mm	D mm	L mm	Ø
3402-08	8	17.0	151	60
3402-09	9	17.9	164	60
3402-10	10	19.8	179	72
3402-11	11	21.6	194	72
3402-12	12	23.0	205	72
3402-13	13	24.7	219	72
3402-14	14	26.3	233	72
3402-15	15	28.4	247	72
3402-16	16	30.5	257	72
3402-17	17	31.8	272	72
3402-18	18	33.2	287	72
3402-19	19	34.0	303	75

ANGLE CLICKKRAFT



Ratschen-Ringgabelschlüssel-Koffer

seitlich abwinkelbar, stufenlos bis zu 180° zum Ratschen auch an schwer zugänglichen Stellen. Arretierungsknopf zur Fixierung des Winkels.

Coffret de clés combinées à cliquet

avec renvoi d'angle par degrés jusqu'à 180° pour intervenir dans les endroits les plus inaccessibles. Bouton d'arrêt pour fixer l'angle désiré.

Valigetta di chiavi combinate a cricchetto

orientabili a regolazione continua fino a 180° per l'utilizzo del cricchetto anche in spazi normalmente inaccessibili. Pulsante di blocco per il bloccaggio con angolazione predefinita.

*Optional / Optionnel / Opzionali



Art.	mm
4900-41K	8-9-10-11-12-13-14-15-16-17-18-19

12
PCS



COMPLETO



421 x 200 x 68 mm

Stecknuss- und Bit-Adapter-Satz

Jeu d'adaptateurs de douilles et d'embouts

Set di adattatori per chiavi a bussola e portainseriti

Art.	mm	□ + ○	D mm
3691	10	1/4" + 1/4"	20

1/4"

1/4"

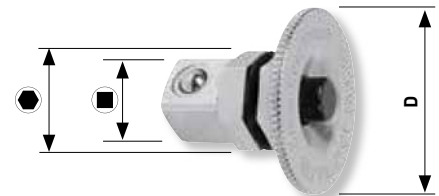

Stecknuss-Adapter

Adaptateur de douilles

Adattatore per chiavi a bussola

Art.	mm	□	D mm
3692	13	3/8"	25

3/8"

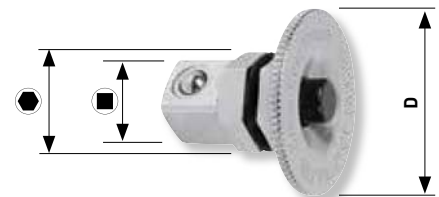

Stecknuss-Adapter

Adaptateur de douilles

Adattatore per chiavi a bussola

Art.	mm	□	D mm
3693	19	1/2"	35

1/2"

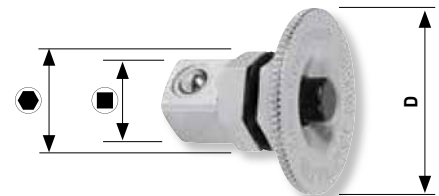

Gabelringschlüssel

voll poliert

Clé combinée

polie miroir

Chiave combinata

lucida

Art.	Ø mm	L mm
3505	5.5	127
3506	6	127
3507	7	134
3508	8	140
3509	9	150
3510	10	159
3511	11	165
3512	12	172
3513	13	179
3514	14	191
3515	15	199
3516	16	206
3517	17	225
3518	18	235
3519	19	248
3520	20	272
3521	21	272
3522	22	291
3523	23	315
3524	24	315
3525	25	335
3526	26	335
3527	27	358
3528	28	402
3530	30	425
3532	32	425
3534	34	375
3536	36	395
3538	38	400
3541	41	435
3546M	46	485
3550M	50	525

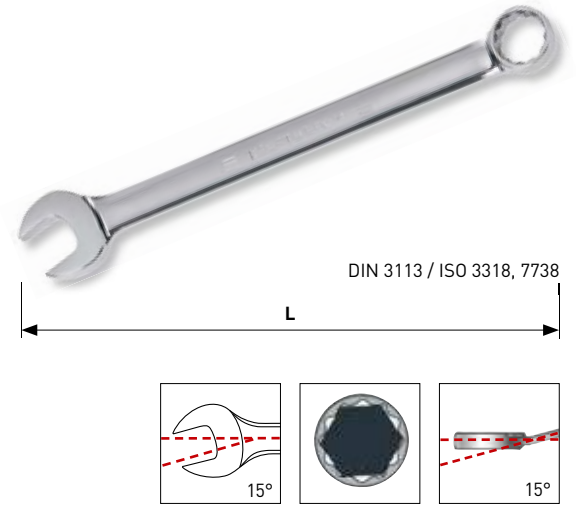

Gabelringschlüssel-Satz

voll poliert, in Kunststoff-Traghalter

Jeu de clés combinées

polies miroir, avec support de transport en plastique

Assortimento di chiavi combinate

lucide, con supporto in plastica facilmente trasportabile

Art.	○ mm
3556	8-9-10-11-12-13 14-15-17-19

10
PCS



Gabelringschlüssel-Satz

voll poliert

Jeu de clés combinées

polies miroir

Assortimento di chiavi combinate

lucide

Art.	○ mm
3550	8-9-10-11-12-13-14 15-16-17-18-19-22

13
PCS



Gabelringschlüssel-Satz

voll poliert

Jeu de clés combinées

polies miroir

Assortimento di chiavi combinate

lucide

Art.	○ mm
3557	5.5-6-7-8-9-10-11-12-13-14 15-16-17-18-19-20-21-22
3557R	5.5-6-7-8-9-10-11-12-13-14 15-16-17-18-19-20-21-22

18
PCS



Canvas

↕ 540 x 420 mm

Doppelgabelschlüssel-Satz

voll poliert

Jeu de clés à fourche

polies miroir

Assortimento di chiavi a forchetta doppia

lucide

Art.	Ø mm
3553	6x7-8x9-10x11-12x13-14x15-16x17 18x19-21x22-24x27-30x32
3553R	6x7-8x9-10x11-12x13-14x15-16x17 18x19-21x22-24x27-30x32

CrV **10**
PCS



Art. 3553



Art. 3553R

Canvas

Gabelringschlüssel-Satz

voll poliert

Jeu de clés combinées

polies miroir

Assortimento di chiavi combinate

lucide

Art.	Ø mm
3558	24-27-30-32
3558R	24-27-30-32

4
PCS



Art. 3558



Art. 3558R

Canvas

↕ 485 x 295 mm

Gabelringschlüssel-Satz

voll poliert

Jeu de clés combinées

polies miroir

Assortimento di chiavi combinate

lucide

Art.	Ø mm
3554	5.5-6-7-8-9-10-11-12-13-14-15-16-17-18-19 20-21-22-23-24-25-26-27-28-30-32
3554R	5.5-6-7-8-9-10-11-12-13-14-15-16-17-18-19 20-21-22-23-24-25-26-27-28-30-32

CrV

26
PCS



Art. 3554



Art. 3554R

Canvas

Gabelringschlüssel-Satz

aus rostfreiem Stahl

Jeu de clés combinées

en acier inoxydable

Assortimento chiavi combinate

in acciaio inossidabile

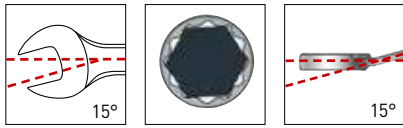

Art.	Ø mm
3503-56	8-10-11-12-13-14-15-17-19

inox

9
PCS



Gabelringschlüssel Zollmasse

voll poliert

Clé combinée en pouce

polie miroir

Chiave combinata in pollici

lucida

Art.	Ø inch	L mm
3587	1/4"	126
3588	5/16"	139
3589	3/8"	160
3590	7/16"	166
3591	1/2"	178
3592	9/16"	190
3593	5/8"	208
3594	11/16"	226
3595	3/4"	250
3596	13/16"	271
3597	7/8"	294
3598	15/16"	314
3599	1"	335

inch

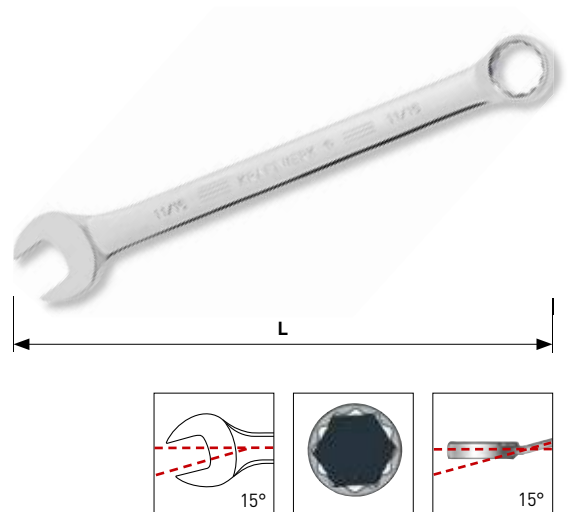

Gabelringschlüssel-Satz Zollmasse

voll poliert

Jeu de clés combinées en pouce

polies miroir

Assortimento di chiavi combinate in pollici

lucide

inch

11
PCS



Art. 3585

Art.	inch
3585	3/8"-7/16"-1/2"-9/16"-5/8"-11/16" 3/4"-13/16"-7/8"-15/16"-1"
3585R	3/8"-7/16"-1/2"-9/16"-5/8"-11/16" 3/4"-13/16"-7/8"-15/16"-1"



Art. 3585R

Canvas

485 x 400 mm

Gabelringschlüssel-Koffer Zollmasse

voll poliert, inkl. 2 Ratschen-Doppelringschlüssel 4-in-1, umschaltbar

Coffret de clés combinées en pouce

polies miroir, inclus 2 clés polygonales à cliquet réversible 4-en-1

Valigetta di chiavi combinate in pollici

lucide, con 2 chiavi poligonali doppie a cricchetto reversibile 4-in-1

inch

15
PCS



COMPLETO

402 x 173 x 48 mm

4in1

REVERSIBLE CLICKRAFT

A 5/16" B 3/8" Art. Nr. 3404-51612 A 7/16" B 1/2"

A 9/16" B 5/8" Art. Nr. 3404-91634 A 11/16" B 3/4"

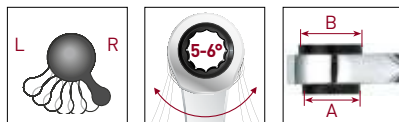

Art.	inch
4900-30K	1/4"-5/16"-3/8"-7/16"-1/2"-9/16"-5/8" 11/16"-3/4"-13/16"-7/8"-15/16"-1"

Doppelgabelschlüssel

voll poliert

Clé à fourche

polie miroir

Chiave a forchetta doppia

lucida

Art.	○ mm	L mm
3560	6 x 7	125
3561	8 x 9	137
3562	10 x 11	149
3551	10 x 13	162
3563	12 x 13	162
3564	14 x 15	188
3565	16 x 17	203
3552	17 x 19	227
3566	18 x 19	227
3567	21 x 22	252
3568	24 x 27	280
3569	30 x 32	310
3579	36 x 41	350
3583	46 x 50	440
3586	55 x 60	505

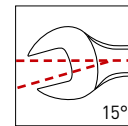

Doppelgabelschlüssel-Satz

voll poliert

Jeu de clés à fourche

polies miroir

Assortimento di chiave a forchetta doppia

lucide

Art.	○ mm
3570	6x7-8x9-10x11-12x13-14x15 16x-17-18x19-21x22
3570R	6x7-8x9-10x11-12x13-14x15 16x-17-18x19-21x22

8
PCS



Art. 3570



Art. 3570R

Canvas

↕ 330 x 310 mm

Rollgabelschlüssel

mit Skala

Clé à molette

graduée

Chiave regolabile a rullino

con scala graduata

Art.	Ø mm	L mm / inch
2404	0 - 14	100 / 4"
2406	0 - 20	150 / 6"
2408	0 - 25	200 / 8"
2410	0 - 30	250 / 10"
2412	0 - 35	300 / 12"
2415	0 - 45	375 / 15"
2418	0 - 55	450 / 18"



Rollgabelschlüssel

mit extra weiter Backenöffnung, schlankem Kopf mit geschliffenen Backen und Millimeter-/Zoll-Skala. Präzise und leichtgängige Backenführung. Brünierte Ausführung.

Clé à molette

avec ouverture extra large, tête fine avec machoire graduée en millimètres et en pouces. Précision et souplesse dans l'écartement des machoires. Finition parkerisée ou brossée.

Chiave regolabile a rullino

con apertura ganasce extra grandi, testa sottile con ganasce rettificata e graduata in millimetri e pollici. Precisa e ganasce facili da azionare. Esecuzione brunita.

Art.	Ø mm	L mm / inch
47122	0 - 27	150 / 6"
47123	0 - 34	200 / 8"
47124	0 - 36	250 / 10"
47125	0 - 45	300 / 12"
47120	47122 + 47123 + 47124	

CrV

HIGHTECH



3
PCS



Art. 47120

Canvas

Einer für Viele – der Duo Quick

Universal-Schraubenschlüssel mit Schnellverstellung. Öffnen des Schlüsselmauls mit einem einzigen Tastendruck. Mit dem Daumen die untere Backe zum Schraubenkopf schieben – die Backe ist millimeter-/zollgenau fixiert und zeigt die Schraubengröße auf der metrischen und der Zoll-Skala an. Der Duo Quick ersetzt jeden herkömmlichen metrischen und Zollschlüssel bis 24 mm / 1 Zoll.

Un pour tous – La clé à molette Duo Quick

avec système de réglage rapide. Ouverture des mâchoires de serrage d'une simple pression du doigt. Positionnez la mâchoire inférieure avec le pouce jusqu'à la tête de la vis – la mâchoire se positionnera au millimètre tout en indiquant les dimensions sur le témoin d'échelle en mm et en pouce. La Duo Quick remplace toutes les clés conventionnelles jusqu'à 24 mm / 1 pouce

Una per tutti - la chiave a rullino Duo Quick

Chiave a rullino universale con regolazione rapida. Ha le ganasce regolabili micrometricamente sulla testa del dado semplicemente azionando il pulsante che libera le ganasce stesse. La chiave Duo Quick sostituisce ogni altra chiave tradizionale, metrica o in pollici fino a 24 mm / 1 pollice.



Art.	Ø mm / inch	L mm / inch
3582	0 - 26 / 0 - 1"	200 / 8"

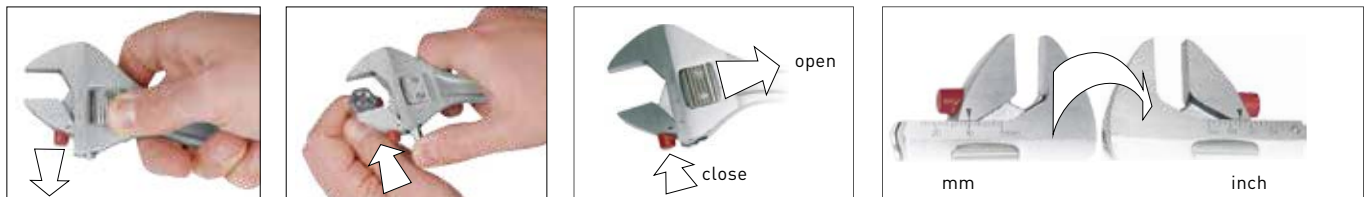

Ratschen-Rollgabelschlüssel

zum schnellen und kraftvollen Anziehen und Lösen von 4-kant- und 6-kant-Schrauben ohne den Schlüssel abzusetzen. Ratschen-Funktions-Ein-/Ausschalter zur Wahl für beweglichen oder festen Schlüsselkopf. Griff aus ergonomischem 2-Komponenten-Material.

Clé à molette à cliquet

pour le serrage et le desserrage rapides de visseries de 4 à 6 pans, sans dégager la clé. Pourvue d'un système révolutionnaire permettant de débrayer la mâchoire. Poignée ergonomique bi-matière.

Chiave a rullino con meccanismo a cricchetto

per un'azione continua. Possibilità di lavorare in modalità standard o cricchetto. Impugnatura ergonomica bimatereale.

Art.	Ø mm / inch	L mm / inch
3577	0 - 25 / 0 - 1"	210 / 8.27"

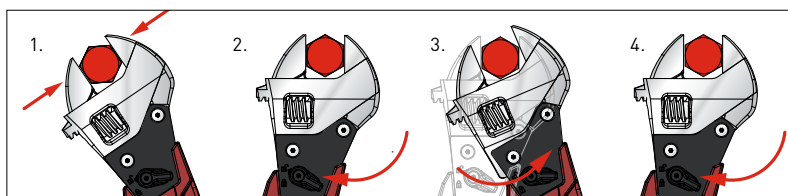

CrMo **ERGOKRAFT**

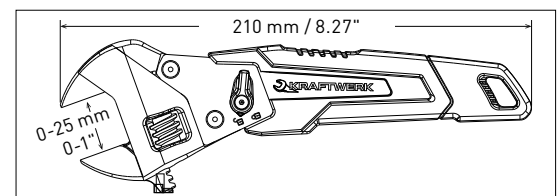

Doppelringschlüssel

voll poliert

Clé polygonale contre-coudée

polie miroir

Chiave poligonale doppia curva

lucida

Art.	○ mm	L mm
3480	6 x 7	165
3481	8 x 9	180
3482	10 x 11	199
3483	12 x 13	218
3484	14 x 15	238
3485	16 x 17	262
3486	18 x 19	287
3487	20 x 22	317
3488	21 x 23	329
3489	24 x 27	346
3491	30 x 32	369
3492	36 x 41	460
3493	46 x 50	520
3494	55 x 60	620



DIN 838 / ISO 1085, 3318, 10104

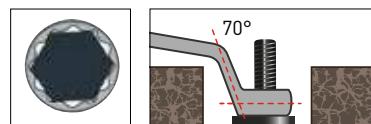

Doppelringschlüssel-Satz

voll poliert

Jeu de clés polygonales contre-coudées

polies miroir

Assortimento di chiavi poligonali doppie curve

lucide

Art.	○ mm
3497	6x7-8x9-10x11-12x13-14x15 16x17-18x19-20x22
3497R	6x7-8x9-10x11-12x13-14x15 16x17-18x19-20x22

8
PCS



Art. 3497R

Canvas

↕ 450 x 390 mm

Doppelringschlüssel-Satz

voll poliert

Jeu de clés polygonales contre-coudées

polies miroir

Assortimento di chiavi poligonali doppie curve

lucide

Art.	⊙ mm
3498	21x23 - 24x27 - 25x28 - 30x32
3498R	21x23 - 24x27 - 25x28 - 30x32

4
PCS



Art. 3498



Art. 3498R

Canvas

↕ 460 x 325 mm

Doppelringschlüssel-Koffer

voll poliert

Coffret de clés polygonales contre-coudées

polies miroir

Valigetta di chiavi poligonali doppie curve

lucide

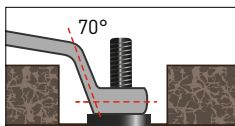

Art.	⊙ mm
4900-15K	6x7-8x9-10x11-12x13-14x15-16x17 18x19-20x22-21x23-24x27-30x32

11
PCS



COMPLETO

↕ 421 x 200 x 68 mm

Doppelringschlüssel Aussen-TX

gerade, voll poliert

Clé polygonale double TX extérieur

plate, polie miroir

Chiave doppia TX esterno

diritta, lucida

Art.	⊙ E	L mm
3546	E6 x E8	112
3547	E10 x E12	140
3548	E14 x E18	180
3549	E20 x E24	223

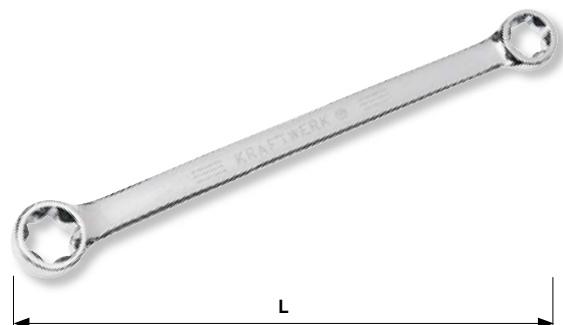

Doppelringschlüssel-Satz Aussen-TX

gerade, voll poliert

Jeu de clés polygonales double TX extérieur

plates, polies miroir

Assortimento di chiavi doppie TX esterno

diritte, lucide

4

PCS



Art.	⊙ E
3545	E6xE8 - E10xE12 - E14xE18 - E20xE24

Offener Doppelring-/Bremsleitungsschlüssel

voll poliert

Clé à tuyauter

polie miroir

Chiave per raccordi tubi

lucida

Art.	⊙ mm	⊙ inch	L mm
3580-00	9 x 11		173
3580-01	10 x 12		175
3580-02	13 x 14		208
3580-03	15 x 17		245
3580-04		3/8" x 7/16"	173
3580-05		1/2" x 9/16"	208
3580-06		5/8" x 11/16"	250



Offener Doppelring-/Bremsleitungsschlüssel-Satz

voll poliert

Jeu de clés à tuyauter

polies miroir

Assortimento di chiavi per raccordi tubi

lucide

7

PCS

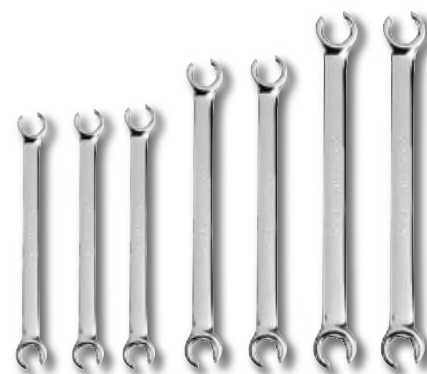

Art.	⊙ mm / inch
3580	9x11 - 10x12 - 13x14 - 15x17 3/8"x7/16" - 1/2"x9/16" - 5/8"x11/16"

Pfeifenkopfschlüssel 6 x 6 kant

voll poliert

Clé à pipe débouchée 6 x 6 pans

polie miroir

Chiave a pipa doppia esagonale

lucida

Art.	Ø mm	L ± mm
2597-06	6	102 ± 3
2597-07	7	106 ± 3
2597-08	8	114 ± 3
2597-09	9	122 ± 3
2597-10	10	129 ± 3
2597-11	11	136 ± 3
2597-12	12	144 ± 4
2597-13	13	152 ± 4
2597-14	14	160 ± 4
2597-15	15	169 ± 4
2597-16	16	178 ± 4
2597-17	17	187 ± 4
2597-18	18	195 ± 4
2597-19	19	204 ± 4
2597-20	20	212 ± 4
2597-21	21	221 ± 5
2597-22	22	230 ± 5
2597-23	23	240 ± 5
2597-24	24	250 ± 5
2597-25	25	260 ± 5
2597-26	26	270 ± 5
2597-27	27	280 ± 5
2597-28	28	290 ± 5
2597-29	29	300 ± 5
2597-30	30	310 ± 5
2597-32	32	330 ± 5

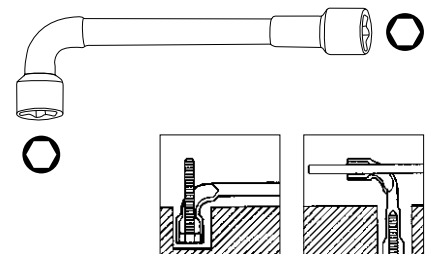
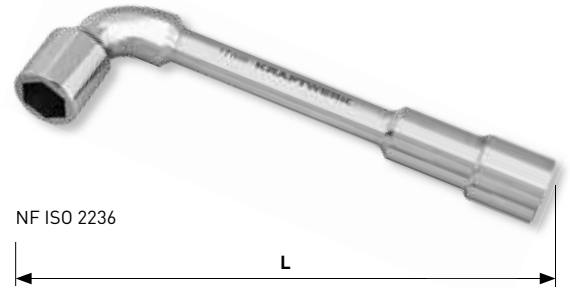

Pfeifenkopfschlüssel 12 x 6 kant

voll poliert

Clé à pipe débouchée 12 x 6 pans

polie miroir

Chiave a pipa doppia esagonale-poligonale

lucida



NF ISO 2236

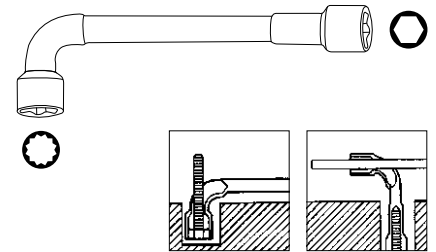
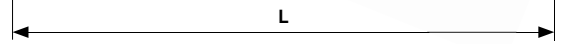

Art.	Ø mm	L ± mm
2598-06	6	102 ± 3
2598-07	7	106 ± 3
2598-08	8	114 ± 3
2598-09	9	122 ± 3
2598-10	10	129 ± 3
2598-11	11	136 ± 3
2598-12	12	144 ± 4
2598-13	13	152 ± 4
2598-14	14	160 ± 4
2598-15	15	169 ± 4
2598-16	16	178 ± 4
2598-17	17	187 ± 4
2598-18	18	195 ± 4
2598-19	19	204 ± 4
2598-20	20	212 ± 4
2598-21	21	221 ± 5
2598-22	22	230 ± 5
2598-23	23	240 ± 5
2598-24	24	250 ± 5
2598-25	25	260 ± 5
2598-26	26	270 ± 5
2598-27	27	280 ± 5
2598-28	28	290 ± 5
2598-29	29	300 ± 5
2598-30	30	310 ± 5
2598-32	32	330 ± 5
2598-34	34	350 ± 5

Pfeifenkopfschlüssel-Satz

voll poliert

Jeu de clés à pipe débouchées

polies miroir

Assortimento di chiavi a pipa

lucide

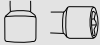
Art.		mm
2597-99	○ ○	8-10-11-12-13-14-16-17-18-19
2598-99	○ ○	8-10-11-12-13-14-16-17-18-19

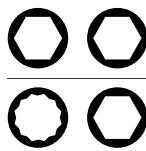

10
PCS



Pfeifenkopfschlüssel-Koffer

voll poliert

Coffret de clés à pipe débouchées

polies miroir

Valigetta di chiavi a pipa

lucide

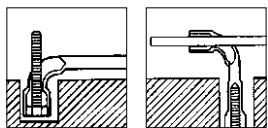

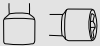
Art.		mm
4900-48K	○ ○	8-9-10-11-12-13-14-15 16-17-18-19-22
4900-18K	○ ○	8-9-10-11-12-13-14-15 16-17-18-19-22

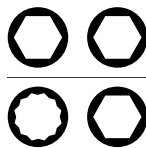

13
PCS



COMPLETO

↕ 421 x 200 x 68 mm

Doppelgelenkschlüssel

voll poliert

Clé à douille articulée

polie miroir

Chiave a bussola poligonale snodata doppia

lucida

Art.	mm	L mm
2590-0809	8 x 9	176
2590-1011	10 x 11	200
2590-1213	12 x 13	216
2590-1415	14 x 15	240
2590-1617	16 x 17	255
2590-1819	18 x 19	270

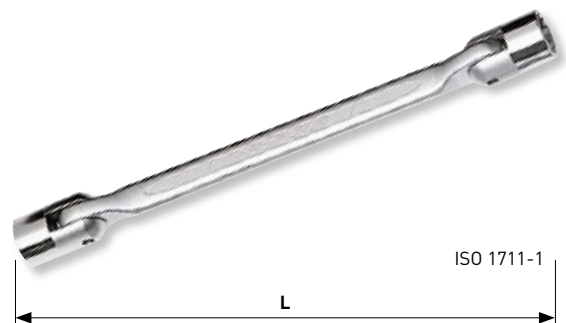

ISO 1711-1



Doppelgelenkschlüssel für Stecknüsse

voll poliert

Clé articulée pour douilles

polie miroir

Chiave doppia a bussola snodata

lucida

Art.	■	L mm
2590-3814	1/4" x 3/8"	255

1/4"

3/8"

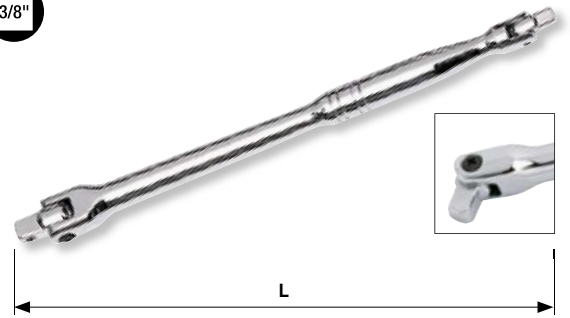

Zündkerzen-Gelenkschlüssel

Clé à bougie articulée

Chiave snodata a T per candele bussola

Art.	○ mm	L mm
2591-16	16	240
2591-21	21	245

AUTOMOTIVE

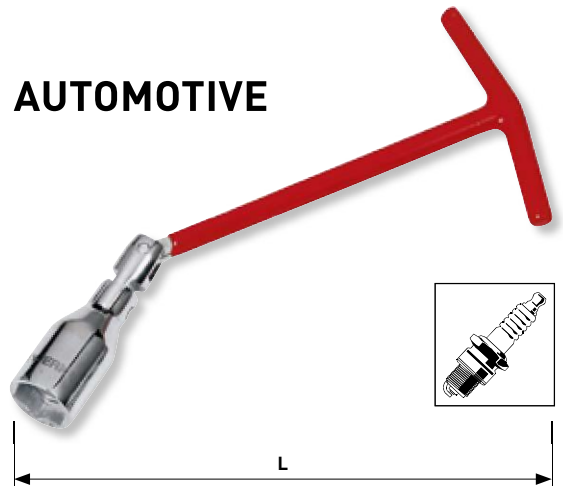

Radhebel mit Doppel-Stecknuss

ausziehbar

Clé démonte-roue avec douille double

téléscopique

Chiave a L per dadi ruote

estensibile

Art.	○ mm	L 1 mm	L 2 mm
2585-1719	17 x 19	365	525
2585-1721	21 x 22	365	525

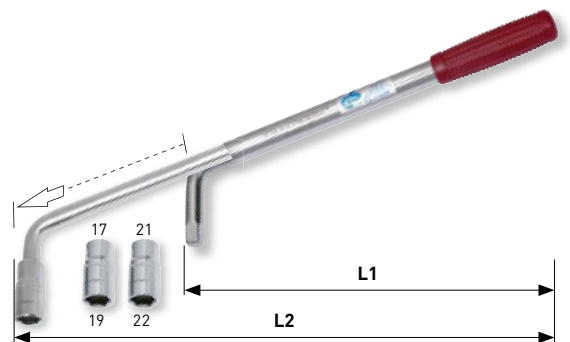

Radkreuz

Clé en croix

Chiave a croce per dadi ruote

Art.	○ mm	■	L mm
2585-12	17-19-22	1/2"	375
2585-34	24-27-32	3/4"	625



T-Griff-Gelenkschlüssel

extra lang

Clé articulée en T

extra longue

Chiave esagonale a T con snodo

extra lungha

Art.	⊙ mm	L mm
2592-08	8	390
2592-09	9	390
2592-10	10	495
2592-11	11	495
2592-12	12	495
2592-13	13	495
2592-14	14	495
2592-15	15	495
2592-16	16	495
2592-17	17	495
2592-18	18	495
2592-19	19	495

XXL

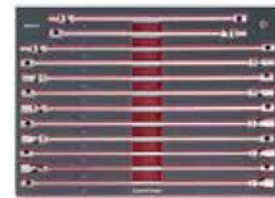
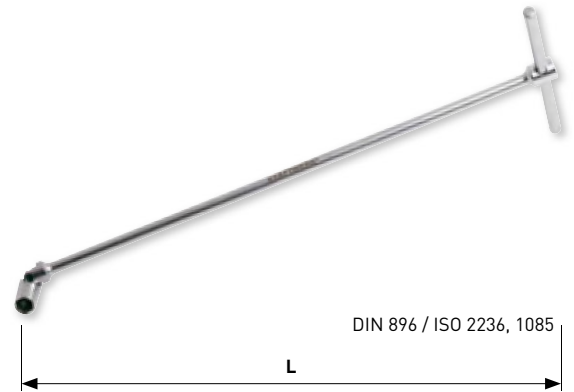

Art. 4902-07
95

Gerader Doppel-/Rohrsteckschlüssel

leichte Ausführung

Clé en tube droite

série légère

Chiave a tubo doppia

serie leggera

Art.	⊙ mm	∅ mm	L mm
2589-0607	6 x 7	5	108
2589-0809	8 x 9	5	110
2589-1011	10 x 11	5	122
2589-1213	12 x 13	5	142
2589-1415	14 x 15	8	143
2589-1617	16 x 17	10	146
2589-1819	18 x 19	10	158
2589-2022	20 x 22	10	175
2589-2123	21 x 23	12	175
2589-2427	24 x 27	12	185
2589-2528	25 x 28	12	190
2589-3032	30 x 32	12	205



Gerader Doppel-/Rohrsteckschlüssel-Satz

leichte Ausführung

Jeu de clés en tube droites

série légère

Assortimento di chiavi a tubo doppie

serie leggera

Art.	Ø mm	Ø mm
2589-01	6x7-8x9-10x11-12x13 14x15-16x17-18x19-20x22	5-8-10

9
PCS



Canvas

↕ 325 x 240 mm

Gerader Doppel-/Rohrsteckschlüssel-Satz

leichte Ausführung

Jeu de clés en tube droites

série légère

Assortimento di chiavi a tubo doppie

serie leggera

Art.	Ø mm	Ø mm
2589-02	21x23 - 24x27 - 25x28 - 30x32	12+14

6
PCS



Canvas

↕ 370 x 345 mm

Stufendrehstift

für gerade Doppel-/Rohrsteckschlüssel

Broche étagée

pour clés en tube droites

Spina di manovra

per chiave a tubo doppie

Art.	Ø mm	L mm
2599-3457	3.5 - 4.5 - 5.5 - 7.5	165
2589-5810	5 - 8 - 10	190
2599-1012	10 - 12	210



Gerader Doppelsteckschlüssel

massive Ausführung, CNC-präzisions-gefertigt

Clé en tube droite

série massive, usinage CNC haute précision

Chiave a tubo doppia

serie pesante, lavorazione precisa a CNC

Art.	○ mm	∅ mm	L mm
2599-0607	6 x 7	3.5	105
2599-0809	8 x 9	3.5	110
2599-1011	10 x 11	4.5	120
2599-1213	12 x 13	5.5	138
2599-1415	14 x 15	5.5	145
2599-1617	16 x 17	8	152
2599-1819	18 x 19	8	162
2599-2022	20 x 22	10	175
2599-2123	21 x 23	10	185
2599-2427	24 x 27	12	195
2599-2528	25 x 28	12	205
2599-3032	30 x 32	12	210

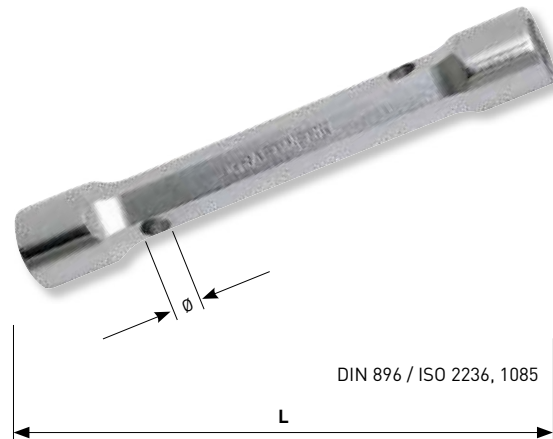

Gerader Doppel-/Rohrsteckschlüssel-Satz

massive Ausführung, CNC-präzisions-gefertigt

Jeu de clés en tube droites

série massive, usinage CNC haute précision

Assortimento di chiavi a tubo doppie

serie pesante, lavorazione precisa a CNC

Art.	○ mm	∅ mm
2599-01	6x7-8x9-10x11-12x13 14x15-16x17-18x19-20x22	5-8-10

9
PCS



Canvas

↕ 325 x 240 mm

Gerader Doppel-/Rohrsteckschlüssel-Satz

massive Ausführung, CNC-präzisions-gefertigt

Jeu de clés en tube droites

série massive, usinage CNC haute précision

Assortimento di chiavi a tubo doppie

serie pesante, lavorazione precisa a CNC

Art.	○ mm	∅ mm
2599-02	21x23 - 24x27 - 25x28 - 30x32	10+12

6
PCS



Canvas

↕ 370 x 345 mm

Ring-Ratschenschlüssel-Satz für Rohrleitungen

Jeu de clés à tuyauter à cliquet

Assortimento di chiavi poligonali a cricchetto per raccordi

Art.
2586

CrMo **8**
PCS



Canvas

Umschaltknarren-Einsatz

Embout cliquet réversible

Testa a cricchetto reversibile

Art.	■
3584-U14	1/4"
3584-U38	3/8"

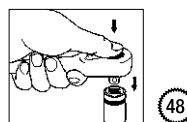

48





ergonomisch kraftvoll *ergonomique puissant* ergonomico robusto



Runder, glatter Griffkopf für reibungsloses Mitgleiten in den Handballen.

Extrémité du manche rond et poli évitant les frictions dans la paume de la main.

Estremità del manico arrotondate e levigate per evitare lo sfregamento con il palmo della mano.



Grosse Durchgangsöffnung zum bequemen Aufhängen an einer Werkzeugwand.

Manche percé permettant d'accrocher le tournevis sur un présentoir.

Il foro ovale permette di appendere il giravite ad una parete portautensili.



Ergonomischer 2-Komponenten Griff.

Manche ergonomique composé de 2 matières antidérapantes.

Manico ergonomico in bimateriale per un maggiore grip.



Fingermulden und Gleitschutz.

Empreinte des doigts pour une meilleure prise en main et protection antiglisse.

Impugnatura antiscivolo con impronta ergonomica per il pollice.



S2-Stahl für professionellen Dauereinsatz.

Acier S2 pour une longévité maximale.

Acciaio S2 di alta qualità per un utilizzo professionale e duraturo.



Passgenaue Antriebs-Spitze nach DIN/ISO-Normen.

Embout précis selon normes DIN/ISO.

Forma dell'impronta precisa, secondo le specifiche DIN/ISO.

Schraubendreher für Schlitzschrauben

Tournevis pour vis à fente

Giravite per viti a testa con intaglio

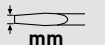
Art.	 mm	 mm	L1 mm	L2 mm
4110-1	0.6	3	75	150
4110-2	0.8	4	100	180
4110-3	1.0	5	100	205
4110-4	1.1	6	150	255
4110-5	1.2	8	150	265
4110-6	1.6	10	200	315



Vergaser-Schraubendreher für Schlitzschrauben

Tournevis carburateur pour vis à fente

Giravite corto per viti a testa con intaglio

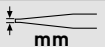
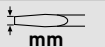
Art.	 mm	 mm	L1 mm	L2 mm
4112-2	1.1	6	38	93

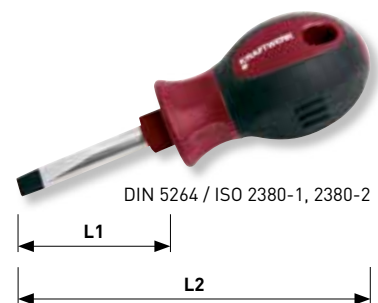

Schlag-Schraubendreher

für Schlitzschrauben, mit durchgehender Klinge und Schlagkappe am Griff. Extra zähe, schlagfeste Black-Point-Spitze, Sechskantklinge und Mehrkomponenten-Kraftformgriff für höchste Drehmomente und optimale Griffigkeit.

Tournevis à frapper

pour vis à fente. Lame traversante munie d'un disque de frappe. Pointe Black-Point extra-dure, résistante aux chocs, lame 6 pans et manche ergonomique avec un revêtement multi-matière pour une prise en main optimale.

Giravite con cappuccio di battuta

per viti a testa con intaglio. Lama passante in corpo unico con il battente. Impronta "black-tip" ultraresistente, lama esagonale e impugnatura ergonomica multi-componente per una presa ottimale.

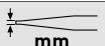
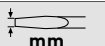
Art.	 mm	 mm	L1 mm	L2 mm
4140-3	1.0	5.5	100	209
4140-4	1.2	6.5	125	233
4140-5	1.4	8.0	150	268
4140-6	1.5	10.0	175	295

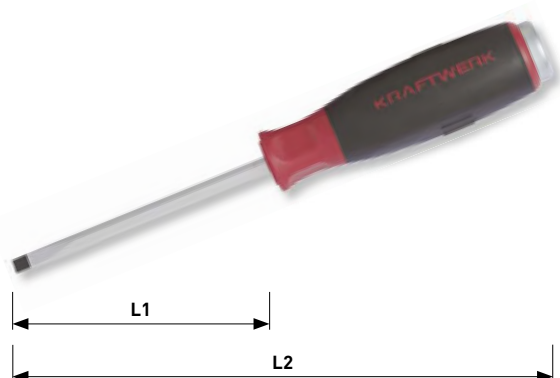

Kreuzschlitz-Schraubendreher für Phillips-Schrauben

Tournevis pour vis Phillips

Giravite per viti con impronta a croce Phillips

Art.	+	L1 mm	L2 mm
4115-0	PH 0	75	150
4115-1	PH 1	75	178
4115-2	PH 2	100	205
4115-3	PH 3	150	265



Vergaser-Schraubendreher für Phillips-Schrauben

Tournevis carburateur pour vis Phillips

Giravite corto per viti con impronta a croce Phillips

Art.	+	L1 mm	L2 mm
4117-2	PH 2	38	93



Schlag-Schraubendreher

für Phillips-Schrauben, mit durchgehender Klinge und Schlagkappe am Griff. Extra zähe, schlagfeste Black-Point-Spitze, Sechskantklinge und Mehrkomponenten-Kraftformgriff für höchste Drehmomente und optimale Griffigkeit.

Tournevis à frapper

pour vis en croix Phillips. Lame traversante munie d'un disque de frappe. Pointe Black-Point extra-dure, résistante aux chocs, lame 6 pans et manche ergonomique avec un revêtement multi-matière pour une prise en main optimale.

Giravite con cappuccio di battuta

per viti a con impronta a croce Phillips. Lama passante in corpo unico con il battente. Impronta "black-tip" ultraresistente, lama esagonale e impugnatura ergonomica multi-componente per una presa ottimale

Art.	+	L1 mm	L2 mm
4145-1	PH 1	75	185
4145-2	PH 2	100	209



Kreuzschlitz-Schraubendreher für Pozidriv-Schrauben

Tournevis pour vis Pozidriv

Giravite per viti con impronta a croce Pozidriv

Art.	✚	L1 mm	L2 mm
4120-0	PZ 0	75	150
4120-1	PZ 1	75	178
4120-2	PZ 2	100	205
4120-3	PZ 3	150	265



Schlag-Schraubendreher

für Pozidriv-Schrauben, mit durchgehender Klinge und Schlagkappe am Griff. Extra zähe, schlagfeste Black-Point-Spitze, Sechskantklinge und Mehrkomponenten-Kraftformgriff für höchste Drehmomente und optimale Griffigkeit.

Tournevis à frapper

pour vis en croix Pozidriv. Lame traversante munie d'un disque de frappe. Pointe Black-Point extra-dure, résistante aux chocs, lame 6 pans et manche ergonomique avec un revêtement multi-matière pour une prise en main optimale.

Giravite con cappuccio di battuta

per viti a con impronta a croce Pozidriv. Lama passante in corpo unico con il battente. Impronta "black-tip" ultraresistente, lama esagonale e impugnatura ergonomica multi-componente per una presa ottimale.



Art.	✚	L1 mm	L2 mm
4150-1	PZ 1	75	185
4150-2	PZ 2	100	209

Schraubendreher für TX-Schrauben

Tournevis pour vis TX

Giravite per viti con impronta TX

Art.	✚	mm	L1 mm	L2 mm
4125-08	T8	2.3	75	153
4125-10	T10	2.7	100	205
4125-15	T15	3.3	100	205
4125-20	T20	3.8	100	205
4125-25	T25	4.4	100	205
4125-27	T27	5.0	100	205
4125-30	T30	5.5	100	205
4125-40	T40	6.6	100	205



Schraubendreher für TX-Schrauben

mit Bohrung an der Spitze, für TX-Schrauben mit und ohne Sicherungsstift

Tournevis pour vis TX

avec pointe percée, pour vis TX normales et TX de sécurité

Giravite per viti con impronta TX

con perforazione sulla punta, per viti TX normali e viti TX Tamper



Art.		 mm	L1 mm	L2 mm
4126-08	T8	2.3	75	153
4126-10	T10	2.7	100	205
4126-15	T15	3.3	100	205
4126-20	T20	3.8	100	205
4126-25	T25	4.4	100	205
4126-27	T27	5.0	100	205
4126-30	T30	5.5	100	205
4126-40	T40	6.6	100	205



Schraubendrehersatz

für Schlitz- und Phillips-Schrauben

Jeu de tournevis

pour vis à fente et Phillips

Serie di giraviti

per viti a testa con intaglio e viti con impronta Phillips

		Art. 4110-1	0.6 x 3 mm
		Art. 4110-2	0.8 x 4 mm
		Art. 4110-3	1.0 x 5 mm
		Art. 4115-1	PH 1
		Art. 4115-2	PH 2

Art.
4162



Schraubendrehersatz



für Schlitz- und Pozidriv-Schrauben

Jeu de tournevis

pour vis à fente et Pozidriv

Serie di giraviti

per viti a testa con intaglio e viti con impronta Pozidriv

	—	Art. 4110-1	0.6 x 3 mm
		Art. 4110-2	0.8 x 4 mm
		Art. 4110-3	1.0 x 5 mm
	+	Art. 4120-1	PZ 1
		Art. 4120-2	PZ 2

Art.

4163

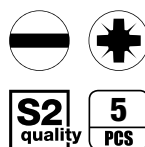

Schraubendrehersatz



für Schlitz- und Phillips-Schrauben

Jeu de tournevis

pour vis à fente et Phillips

Serie di giraviti

per viti a testa con intaglio e viti con impronta Phillips

	—	Art. 4110-1	0.6 x 3 mm
		Art. 4110-2	0.8 x 4 mm
		Art. 4110-3	1.0 x 5 mm
		Art. 4110-4	1.1 x 6 mm
		Art. 4110-5	1.2 x 8 mm
	+	Art. 4115-1	PH 1
		Art. 4115-2	PH 2

Art.

4160

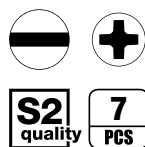

Schraubendrehersatz



für Schlitz- und Pozidriv-Schrauben

Jeu de tournevis

pour vis à fente et Pozidriv

Serie di giraviti

per viti a testa con intaglio e viti con impronta Pozidriv

	—	Art. 4110-1	0.6 x 3 mm
		Art. 4110-2	0.8 x 4 mm
		Art. 4110-3	1.0 x 5 mm
		Art. 4110-4	1.1 x 6 mm
		Art. 4110-5	1.2 x 8 mm
	+	Art. 4120-1	PZ 1
		Art. 4120-2	PZ 2

Art.

4161

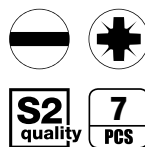

Schraubendrehersatz

für TX-Schrauben

Jeu de tournevis

pour vis TX

Serie di giraviti

per viti con impronta TX

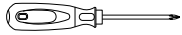

Art. 4125-08	T8
Art. 4125-10	T10
Art. 4125-15	T15
Art. 4125-20	T20
Art. 4125-25	T25
Art. 4125-27	T27
Art. 4125-30	T30
Art. 4125-40	T40

Art.

4165



S2
quality

8
PCS



Schraubendrehersatz

mit Bohrung an der Spitze, für TX-Schrauben mit und ohne Sicherungsstift

Jeu de tournevis

avec pointe percée, pour vis TX normales et TX de sécurité

Serie di giraviti

con perforazione sulla punta, per viti TX normali e viti TX Tamper

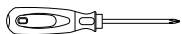

Art. 4126-08	T8
Art. 4126-10	T10
Art. 4126-15	T15
Art. 4126-20	T20
Art. 4126-25	T25
Art. 4126-27	T27
Art. 4126-30	T30
Art. 4126-40	T40

Art.

4166



S2
quality

8
PCS



Universal-Schraubendreher- / Bitkoffer

für Schlitz-, Phillips-, Pozidriv- und TX-Schrauben

Coffret universel de tournevis et embouts

pour vis à fente, Phillips, Pozidriv et TX

Valigetta di giraviti ed inserti

per viti a testa con intaglio e viti con impronte Phillips, Pozidriv e TX

	●	Art. 4110-1	0.6 x 3 mm
		Art. 4110-2	0.8 x 4 mm
		Art. 4110-3	1.0 x 5 mm
		Art. 4110-4	1.1 x 6 mm
		Art. 4110-5	1.2 x 8 mm
		Art. 4110-6	1.6 x 10 mm

	●	Art. 4112-2	1.1 x 6 mm
---	---	-------------	------------

	+	Art. 4115-0	PH 0
		Art. 4115-1	PH 1
		Art. 4115-2	PH 2
		Art. 4115-3	PH 3

	+	Art. 4117-2	PH 2
---	---	-------------	------

	+	Art. 4120-0	PZ 0
		Art. 4120-1	PZ 1
		Art. 4120-2	PZ 2
		Art. 4120-3	PZ 3

	○	Art. 4128	1/4"
---	---	-----------	------

	★	T10-T15-T20-T25-T27-T30-T40	
---	---	-----------------------------	--

Art.

4168

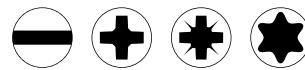

S2 quality 24 PCS



380 x 250 x 72 mm

Schraubendreher-Koffer

für Schlitz- und Phillips-Schrauben

Coffret de tournevis

pour vis à fente et Phillips

Valigetta di giraviti

per viti a testa con intaglio e viti con impronte Phillips

	●	Art. 4110-1	0.6 x 3 mm
		Art. 4110-2	0.8 x 4 mm
		Art. 4110-3	1.0 x 5 mm
		Art. 4110-4	1.1 x 6 mm
		Art. 4110-5	1.2 x 8 mm

	●	Art. 4112-2	1.1 x 6 mm
---	---	-------------	------------

	+	Art. 4115-1	PH 1
		Art. 4115-2	PH 2

	+	Art. 4117-2	PH 2
---	---	-------------	------

		Art. 2138	100-250V	
---	--	-----------	----------	---

		Art. 2139	12V
---	--	-----------	-----

Art.

4900-04K



S2 quality 11 PCS



421 x 200 x 68 mm

COMPLETO

Schraubendreher-Koffer

für TX-Schrauben und Schlitz-/Phillips-Kleinschrauben

Coffret de tournevis

pour vis TX et petites vis à fente et Phillips

Valigetta di giraviti

per viti con impronta TX, per viti piccole con testa ad intaglio e con impronte Phillips

	•	Art. 4125-08	T8
		Art. 4125-10	T10
		Art. 4125-15	T15
		Art. 4125-20	T20
		Art. 4125-25	T25
		Art. 4125-27	T27
		Art. 4125-30	T30
		Art. 4125-40	T40

	—	Art. 3177-20	0.45 x 2.0 mm
		Art. 3177-24	0.5 x 2.4 mm
		Art. 3177-30	0.6 x 3.0 mm
		Art. 3177-35	0.65 x 3.5 mm

	+	Art. 3177-0	PH 0
		Art. 3177-1	PH 1

Art.

4900-05K

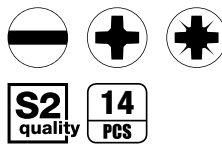

COMPLETO



421 x 200 x 68 mm

Schlag-Schraubendreher-Koffer

für Schlitz- und Kreuzschlitz-Phillips und -Poizdriv-Schrauben, mit durchgehender Klinge und Schlagkappe am Griff. Extra zähe, schlagfeste Black-Point-Spitze, Sechskantklinge und Mehrkomponenten-Kraftformgriff für höchste Drehmomente und optimale Griffigkeit.

Coffret de tournevis à frapper

pour vis à fente, Phillips et Pozidriv. Lame traversante munie d'un disque de frappe. Pointe Black-Point extra-dure, résistante aux chocs, lame 6 pans et manche ergonomique avec revêtement multi-matière pour une prise en main optimale.

Valigetta di giraviti con cappuccio di battuta

per viti a testa con intaglio, viti con impronta Phillips e Pozidriv. Lama passante in corpo unico con il battente. Impronta "black-tip" ultrarestistente, lama esagonale e impugnatura ergonomica multi-componente per una presa ottimale.

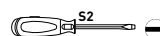
	—	Art. 4140-3	5.5 x 100 mm	5.5 mm
		Art. 4140-4	6.5 x 125 mm	6.5 mm
		Art. 4140-5	8.0 x 150 mm	8.0 mm
		Art. 4140-6	10.0 x 175 mm	10.0 mm

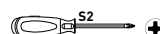
	+	Art. 4145-1	PH1 x 75 mm	5.0 mm
		Art. 4145-2	PH2 x 100 mm	6.0 mm

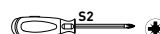
	+	Art. 4150-1	PZ1 x 75 mm	5.0 mm
		Art. 4150-2	PZ2 x 100 mm	6.0 mm

Art.

4900-54K

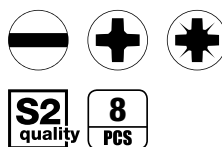

COMPLETO



402 x 173 x 48 mm



Schraubendreher-Satz

aus rostfreiem Stahl, für Schlitz-, Phillips- und Pozidriv-Schrauben

Jeu de tournevis

en acier inoxydable, pour vis à fente, Phillips et Pozidriv

Serie di giraviti

in acciaio inossidabile, per viti a testa con intaglio e viti con impronte Phillips e Pozidriv

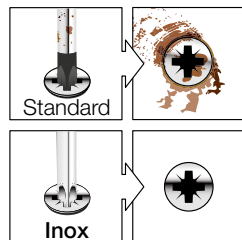
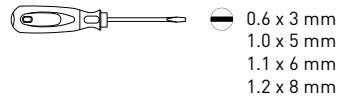

Art.

4170



inox 8 PCS



Ratschen-Kombiklingen-Schraubendreher-Satz

mit 8 Doppelend-Klingen (= 16 Schraubendreher) und Klinge mit Bit-Adapter. Stufenlos verstellbare Klingenlänge 50 - 150 mm.

Jeu de tournevis réversibles à cliquet

avec 8 lames réversibles (= 16 tournevis) et lame avec adaptateur pour embouts. Longueur de la lame variable de 50 à 150 mm.

Serie di giravite a cricchetto reversibile

dotato di 8 lame doppie per un totale di 16 impronte azionabili e lama portainseriti. La lunghezza della lama può essere regolata da 50 a 150 mm di estensione.

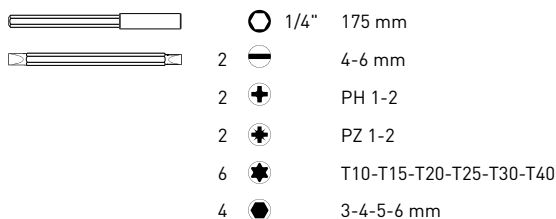

1/4" 175 mm

2 4-6 mm

2 PH 1-2

2 PZ 1-2

6 T10-T15-T20-T25-T30-T40

4 3-4-5-6 mm

Art.

L
mm

4135

175

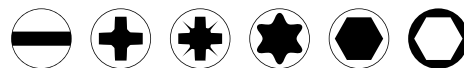

S2 quality 10 PCS



205 x 115 x 50 mm

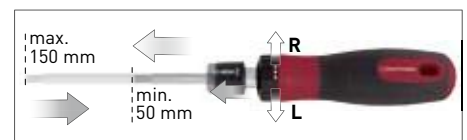

Schraubendreher-/Bit-Satz

für Schlitz-/Phillips-Schrauben und viele Kleinschrauben

Jeu de tournevis et embouts

pour vis à fente et Phillips et de nombreuses petites vis

Serie di giraviti ed inserti

per viti a testa con intaglio, per viti con impronte Phillips e molte viti piccole



4 0.6 x 3 - 0.8 x 4 - 1.0 x 5 - 1.1 x 6 mm

2 PH 1-2

4 mm

Art.
4164

Sechskant-Steckschlüssel-Schraubendreher

Clé à douille six pans emmanchée

Chiave a bussola esagonale con impugnatura



ERGOKRAFT

Art.	mm	L1 mm	L2 mm
4127-055	5.5	150	255
4127-06	6	150	255
4127-07	7	150	255
4127-08	8	150	265
4127-10	10	150	265
4127-11	11	150	265
4127-12	12	150	265
4127-13	13	150	265



**Sechskant-Steckschlüssel-
Schraubendreherkoffer**

Coffret de clés à douille six pans emmanchées

**Valigetta di chiavi a bussola esagonale
con impugnatura**

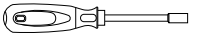

COMPLETO

	Art. 4127-055	5.5 mm
	Art. 4127-06	6 mm
	Art. 4127-07	7 mm
	Art. 4127-08	8 mm
	Art. 4127-10	10 mm
	Art. 4127-11	11 mm
	Art. 4127-12	12 mm
	Art. 4127-13	13 mm

Art.

4900-31K



↕ 421 x 200 x 68 mm

Einsteck-Schraubendreher-Bithalter

magnetisch

Tournevis porte-embouts

magnétique

Giravite portainseriti

magnetico

Art.	⊙	L1 mm	L2 mm
4128	1/4"	100	205
4130	5/16"	100	205

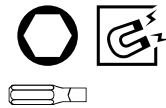

ERGOKRAFT

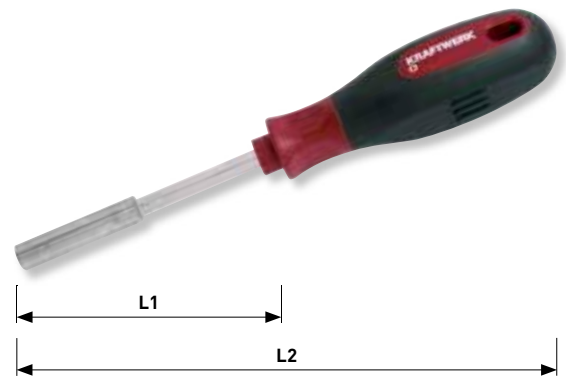

Flexibler Sechskant-Steckschlüssel-Steckgriff

Clé à douille six pans emmanchée, flexible

**Chiave a bussola esagonale flessibile
con impugnatura**

Art.	⊙ mm	L1 mm	L2 mm
109060	6	158	270
109070	7	158	270
109080	8	158	270
109090	9	176	292
109100	10	176	292
109110	11	176	292



ERGOKRAFT

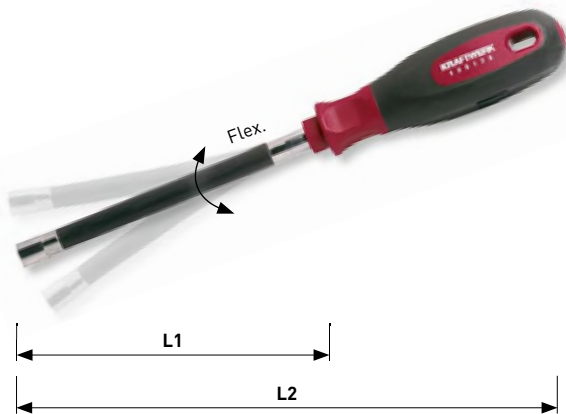

Steckgriff

mit 1/4" Innenvierkant im Griffende

Rallonge

avec manche carré

Porta bussola

con attacco quadro da 1/4" all'interno dell'impugnatura

Art.	■	L1 mm	L2 mm
109150	1/4"	70	150

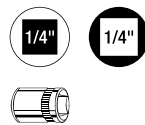

DIN 3122 / ISO 3315

2-Komponenten-Steckgriff

mit 1/4" Innenvierkant im Griffende

Rallonge à manche bi-matière

avec manche carré

Porta bussole con impugnatura bimeriale

con attacco quadro da 1/4" all'interno dell'impugnatura

Art.		L1 mm	L2 mm
109151	1/4"	51	153

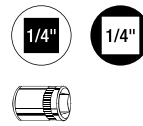

ERGOKRAFT



Flexibler 2-Komponenten-Steckgriff

Rallonge flexible avec manche bi-matière

Porta bussole flessibile con impugnatura bimeriale

Art.		L1 mm	L2 mm
109175	1/4"	158	270

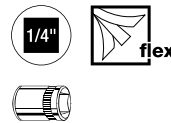

ERGOKRAFT

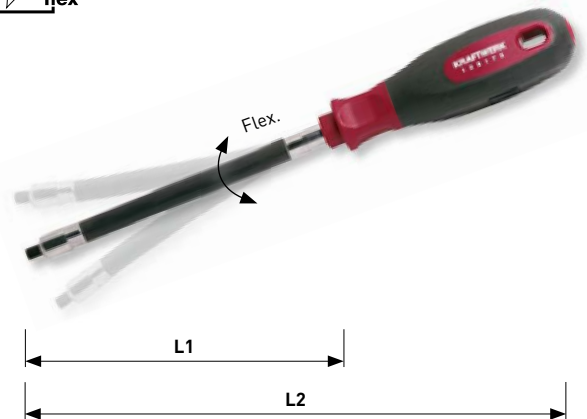



10 in 1 Universal-Kreuzschlitz-Schraubendreher
für PH + PZ Nr. 0-1-2-3-4 mit zweiseitiger Klinge für Phillips- auf der einen Seite und Pozidriv-Schrauben auf der anderen Seite.

Tournevis cruciforme universel 10 en 1

pour PH + PZ Nos 0-1-2-3-4 avec lame réversible, un côté pour vis Phillips et l'autre côté pour vis Pozidriv.

Giravite a croce universale 10 in 1

a lama doppia per impronte Phillips e Pozidriv coprendo tutte le misure 0-1-2-3-4 di entrambe le impronte.

Art.	 	L1 mm	L2 mm
4132	PH 0-1-2-3-4 PZ 0-1-2-3-4	103	215

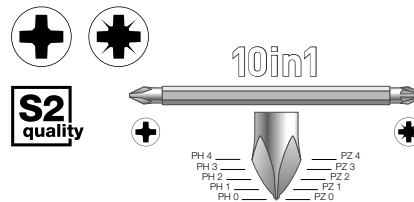

ERGOKRAFT



Schraubendreher-Magnetisierer/-Entmagnetisierer

Adaptateur/convertisseur magnétique pour tournevis

Magnetizzatore per giraviti

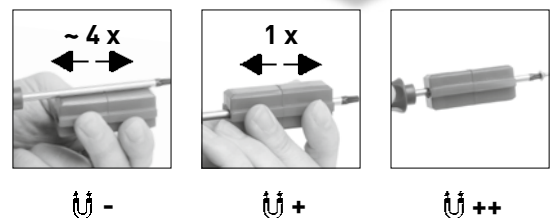

Art.
2187



Elektriker-Schraubendreher für Schlitzschrauben

Tournevis électricien pour vis à fente

Giravite isolato per viti a testa con intaglio

Art.	 mm	 mm	L1 mm	L2 mm
3132-1	0.4	2.5	75	155
3132-2	0.8	3.0	100	180
3132-3	1.0	3.5	100	180
3132-4	1.2	4.0	100	180



1000 V

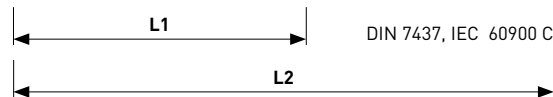

Elektriker-Kreuzschlitz-Schraubendreher für Phillips-Schrauben

Tournevis électricien pour vis Phillips

Giravite isolato

per viti con impronta a croce Phillips

Art.		L1 mm	L2 mm
3135-0	PH 0	60	140
3135-1	PH 1	80	160
3135-2	PH 2	100	205



1000 V

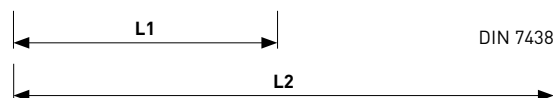

Elektriker-Kreuzschlitz-Schraubendreher für Pozidriv-Schrauben

Tournevis électricien pour vis Pozidriv

Giravite isolato

per viti con impronta a croce Pozidriv

Art.		L1 mm	L2 mm
3137-0	PZ 0	60	140
3137-1	PZ 1	80	160
3137-2	PZ 2	100	205



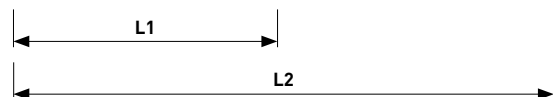

1000 V



Elektriker-Schraubendreher für TX-Schrauben

Tournevis électricien pour vis TX

Giravite isolato per viti con impronta TX

Art.		 mm	L1 mm	L2 mm
3133-15	T15	3.3	100	180
3133-20	T20	3.8	100	180



1000 V

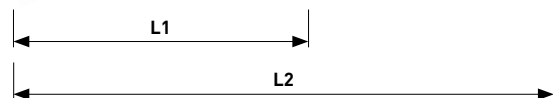

Elektriker-Schraubendreher-Satz



für Schlitz- und Phillips-Schrauben

Jeu de tournevis électrique

pour vis à fente et Phillips

Serie di giraviti isolati per elettricisti

per viti a testa con intaglio e viti con impronta Phillips

	●	Art. 3132-1	2.5 x 75 mm
		Art. 3132-4	4.0 x 100 mm
		Art. 3132-5	5.5 x 125 mm
		Art. 3132-6	6.5 x 150 mm
	⊕	Art. 3135-0	PH 0 x 60 mm
		Art. 3135-1	PH 1 x 80 mm
		Art. 3135-2	PH 2 x 100 mm
	●	Art. 2138	100-250 V

Art.

3157



Spannungsprüfer 100-250 V

Tournevis testeur de tension 100-250 V

Giravite cercafase 100-250 V

Art.	 mm	L1 mm	L2 mm
2138	3	60	140

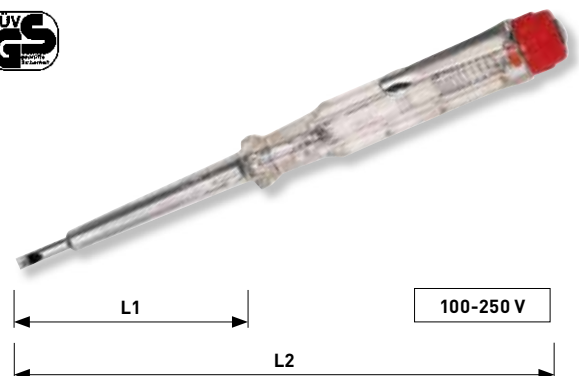

Spannungsprüfer 12 V

Tournevis testeur de tension 12 V

Giravite cercafase 12 V

Art.

2139



T-Griff-Schraubendreher-Bithalter

magnetisch

Tournevis porte-embouts emmanché en T magnétique

Giravite portainseriti con impugnatura a T magnetico

Art.	L1 mm	L2 mm
3634	150	210

Kugelpfopf-T-Griff-Schraubendreher für Innensechskantschrauben

Clé mâle emmanchée en T avec tête sphérique

Chiave esagonale a testa sferica con impugnatura a T

Art.	mm	L1 mm	L2 mm
3636-2	2	100	145
3636-2.5	2.5	100	145
3636-3	3	100	140
3636-4	4	150	195
3636-5	5	150	210
3636-6	6	150	210
3636-7	7	150	210
3636-8	8	200	260
3636-10	10	200	280
3636-12	12	200	280

Kugelpfopf-T-Griff-Schraubendreherkoffer für Innensechskantschrauben

Coffret de clés mâles emmanchées en T avec tête sphérique

Valigetta di chiavi esagonali a testa sferica con impugnatura a T

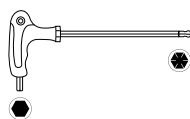

- Art. 3636-3 3 mm
- Art. 3636-4 4 mm
- Art. 3636-5 5 mm
- Art. 3636-6 6 mm
- Art. 3636-7 7 mm
- Art. 3636-8 8 mm
- Art. 3636-10 10 mm



Art.
4900-25K



T-Griff-Schraubendreher für TX-Schrauben

mit Bohrung an der kurzen Spitze, für TX-Schrauben mit und ohne Sicherungsstift



Clé TX emmanchée à poignée en T

avec pointe percée, pour vis TX normales et TX de sécurité

Chiave TX con impugnatura a T

con perforazione sulla punta corta, per viti TX normali e viti TX Tamper



Art.	 	 mm	L1 mm	L2 mm
3637-10	T10	2.7	100	145
3637-15	T15	3.3	100	145
3637-20	T20	3.8	100	145
3637-25	T25	4.4	150	210
3637-27	T27	5.0	150	210
3637-30	T30	5.5	150	210
3637-40	T40	6.6	200	260
3637-45	T45	7.82	200	260
3637-50	T50	8.83	200	280
3637-55	T55	11.22	200	280



T-Griff-Schraubendreher-Koffer für TX-Schrauben

mit Bohrung an der kurzen Spitze, für TX-Schrauben mit und ohne Sicherungsstift

Coffret de clés TX emmanchées à poignée en T

avec pointe percée, pour vis TX normales et TX de sécurité

Valigetta di chiavi TX con impugnatura a T

con perforazione sulla punta corta, per viti TX normali e viti TX Tamper



COMPLETO

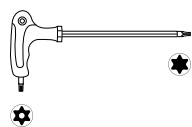

Art. 3637-10	T10
Art. 3637-15	T15
Art. 3637-20	T20
Art. 3637-25	T25
Art. 3637-27	T27
Art. 3637-30	T30
Art. 3637-40	T40

Art.

4900-26K



 421 x 200 x 68 mm

**Präzisions-Schraubendreher
für Schlitzschrauben**

Tournevis de précision pour vis à fente

**Giravite di precisione
per viti a testa con intaglio**

Art.	 mm	 mm	L1 mm	L2 mm
3177-15	0.4	1.5	50	150
3177-20	0.45	2.0	50	150
3177-24	0.5	2.4	50	150
3177-30	0.6	3.0	50	150
3177-35	0.65	3.5	50	150
3177-40	0.8	4.0	50	150

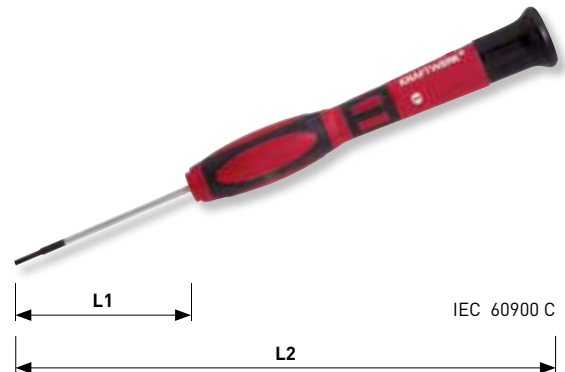

**Präzisions-Kreuzschlitz-Schraubendreher
für Phillips-Schrauben**

Tournevis de précision pour vis Phillips

**Giravite di precisione
per viti con impronta a croce Phillips**

Art.		L1 mm	L2 mm
3177-00	PH 00	50	150
3177-0	PH 0	50	150
3177-1	PH 1	50	150

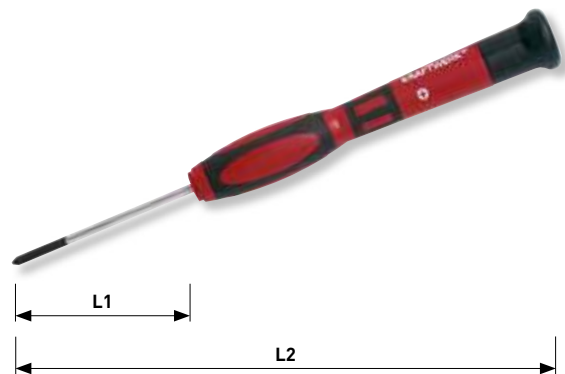

**Präzisions-Kreuzschlitz-Schraubendreher
für Pozidriv-Schrauben**

Tournevis de précision pour vis Pozidriv

**Giravite di precisione
per viti con impronta a croce Pozidriv**

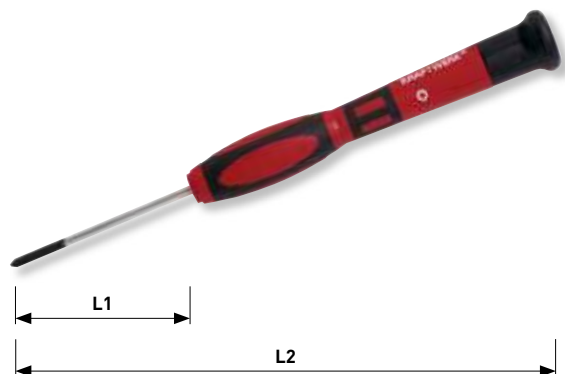

Art.		L1 mm	L2 mm
3178-0	PZ 0	50	150
3178-1	PZ 1	50	150



Präzisions-Schraubendreher für TX-Schrauben

Tournevis de précision pour vis TX

Giravite di precisione per viti con impronta TX

Art.		 mm	L1 mm	L2 mm
3178-05	T5	1.42	50	150
3178-06	T6	1.7	50	150
3178-07	T7	1.99	50	150
3178-08	T8	2.3	50	150



Präzisions-Schraubendreher für TX-Schrauben
mit Bohrung an der Spitze, für TX-Schrauben mit und ohne Sicherungsstift



Tournevis de précision pour vis TX

avec pointe percée, pour vis TX normales et TX de sécurité

Giravite di precisione per viti con impronta TX

con perforazione sulla punta corta, per viti TX normali e viti TX Tamper

Art.		mm	L1 mm	L2 mm
3178-09	T9	2.5	50	150
3178-10	T10	2.7	50	150
3178-15	T15	3.3	50	150
3178-20	T20	3.8	50	150



Präzisions-Schraubendrehersatz

für Schlitz- und Phillips-Schrauben

Jeu de tournevis de précision

pour vis à fente et Phillips

Serie di giraviti di precisione

per viti a testa con intaglio e viti con impronta Phillips



- Art. 3177-20 0.45 x 2.0 mm
- Art. 3177-24 0.50 x 2.4 mm
- Art. 3177-30 0.60 x 3.0 mm
- Art. 3177-35 0.65 x 3.5 mm
- Art. 3177-40 0.80 x 4.0 mm



- Art. 3177-00 PH 00
- Art. 3177-0 PH 0
- Art. 3177-1 PH 1

Art.
3177



8
PCS



Präzisions-Schraubendrehersatz

für TX-Schrauben

Jeu de tournevis de précision

pour vis TX

Serie di giraviti di precisione

per viti con impronta TX



- Art. 3178-05 T5
- Art. 3178-06 T6
- Art. 3178-07 T7
- Art. 3178-08 T8



- Art. 3179-09 T9
- Art. 3179-10 T10
- Art. 3179-15 T15
- Art. 3179-20 T20

Art.
3178



8
PCS



Universal-Präzisions-Bit-Satz

Jeu de tournevis de précision universel

Set universale inserti e portainseriti di precisione

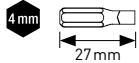

- 5 1.5-2-2.5-3-4 mm
- 3 PH000-PH00-PH0
- 2 PZ00-PZ0
- 4 T4-T5-T6-T7
- 3 T8-T9-T10-T15
- 3 1.5-2-2.5 mm
- 1 4.0 x 95 mm

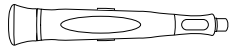

Art.

3180

Universal-Präzisions-Bit-Satz

mit extra langen Bits

Jeu de tournevis de précision universel

avec embouts extra longs

Set universale inserti e portainseriti di precisione

con inserti extra lunghi



- 5 0.8-1.0-1.5-2.0-3.0 mm
- 4 PH 000-00-0-1
- 3 T3-T4-T5
- 5 T6-T8-T9-T10-T15
- 6 0.7-0.9-1.3-1.5-2.0-2.5 mm

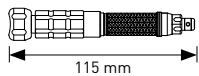

Art.

3181

Elektronik-/Präzisions-Werkzeug-Satz

Praktisches und kompaktes Werkzeug-Sortiment für alle Elektronik-Arbeiten (inkl. Handys, Computer). In Reißverschlussstasche.

Jeu d'outils de précision pour l'électronique

Assortiment d'outils pratique et compact pour tous les travaux électroniques (y compris tél. portables, ordinateurs).

Dans une trousse à fermeture éclair.

Set utensili di precisione per elettronica

Assortimento di utensili pratico e compatto per tutti i lavori di elettronica (incl. Telefonini, Computer). In borsetta con zip.

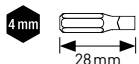

- 5 1.0-1.5-2.0-2.5-3.0 mm
- 4 PH 000-00-0-1
- 3 T3-T4-T5
- 6 T6-T7-T8-T9-T10-T15
- 3 P2-P5-P6
- 6 0.9-1.3-1.5-2.0-2.5-3.0 mm
- 4 1.6-2.0-2.2-2.3 mm
- 2 No. 0-1
- 2 No. 0-1
- 1 0.8 mm
- 6 2.5-3.0-3.5-4.0-4.5-5.0 mm



Art.

3182

4 mm

CrV

22
PCS



105 x 70 x 35 mm

4 mm

CrV

24
PCS



178 x 89 x 35 mm



4 mm

51
PCS



195 x 105 x 35 mm

Winkelstiftschlüssel für Innensechskantschrauben

matt verchromt

Clé mâle coudée pour vis 6 pans creux

chromée satinée

Chiave maschio esagonale

cromata satinata



Art.	mm	L mm
3601-1.5	1.5	46.0
3601-2	2.0	52.0
3601-2.5	2.5	58.5
3601-3	3.0	66.0
3601-4	4.0	74.0
3601-5	5.0	84.0
3601-6	6.0	95.0
3601-8	8.0	108.0
3601-10	10.0	121.0

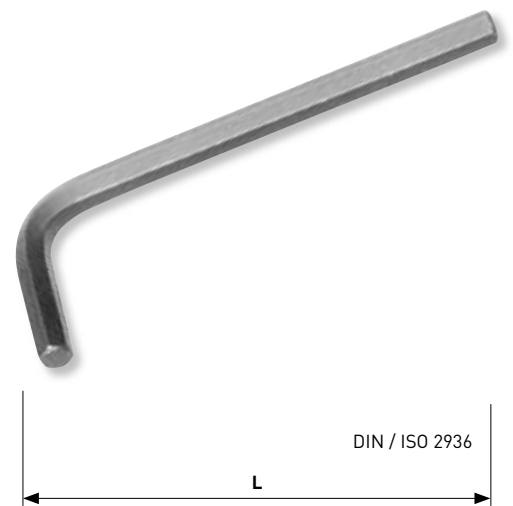

Winkelstiftschlüssel-Satz für Innensechskantschrauben

matt verchromt

Jeu de clés mâles coudées pour vis 6 pans creux

chromées satinées

Serie di chiavi maschio esagonale

cromate satinata



DIN / ISO 2936

Art.	mm
3601	1.5-2-2.5-3-4-5-6-8-10



Winkelstiftschlüssel-Satz für Innensechskantschrauben

aus rostfreiem Stahl

Jeu de clés mâles coudées

pour vis 6 pans creux

en acier inoxydable

Serie di chiavi maschio brugola esagonale

in acciaio inossidabile



DIN / ISO 2936

Art.	mm
3641	1.5-2-2.5-3-4-5-6-8-10



**Kugelpfopf-Winkelstiftschlüssel
für Innensechskantschrauben**

lang, poliert und matt verchromt

*Clé mâle coudée à tête sphérique
pour vis 6 pans creux*

longue, polie et chromée satinée

Chiave maschio esagonale a testa sferica

lunga, lucida e cromata satinata

Art.	 mm	L mm
3602-1.5	1.5	63.5
3602-2	2.0	77.0
3602-2.5	2.5	87.5
3602-3	3.0	93.0
3602-4	4.0	104.0
3602-5	5.0	120.0
3602-6	6.0	141.0
3602-7	7.0	147.0
3602-8	8.0	158.0
3602-10	10.0	180.0

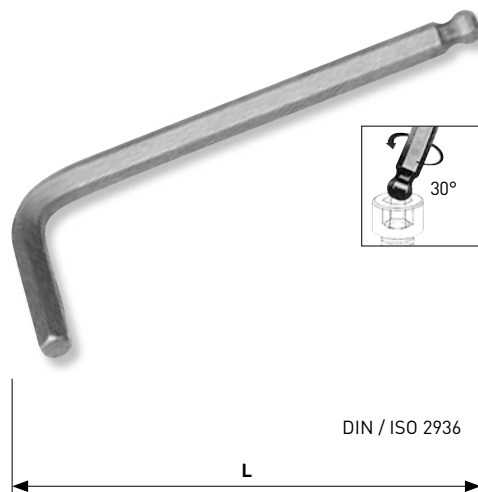
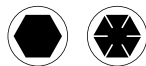

**Kugelpfopf-Winkelstiftschlüssel-Satz
für Innensechskantschrauben**

lang, poliert und matt verchromt

*Jeu de clés mâles coudées à tête sphérique
pour vis 6 pans creux*

longues, polies et chromées satinées

Serie di chiavi maschio esagonali a testa sferica

lunghe, lucide e cromate satinata

Art.	 mm
3602	1.5-2-2.5-3-4-5-6-7-8-10



DIN / ISO 2936



Kugelkopf-Winkelstiftschlüssel-Satz für Innensechskantschrauben

lang, aus rostfreiem Stahl

*Jeu de clés mâles coudées à tête sphérique
pour vis 6 pans creux*

longues, en acier inoxydable

**Serie di chiavi maschio esagonali a testa sferica
lunghe, in acciaio inossidabile**



DIN / ISO 2936



Art.	mm
3642	1.5-2-2.5-3-4-5-6-8-10

Kugelkopf-Winkelstiftschlüssel für Innensechskantschrauben

extra lang, poliert und matt verchromt

*Clé mâle coudée à tête sphérique
pour vis 6 pans creux*

extra longue, polie et chromée satinée

**Chiave maschio esagonale
piegata a testa sferica**

extra lunga, lucida e cromata satinata

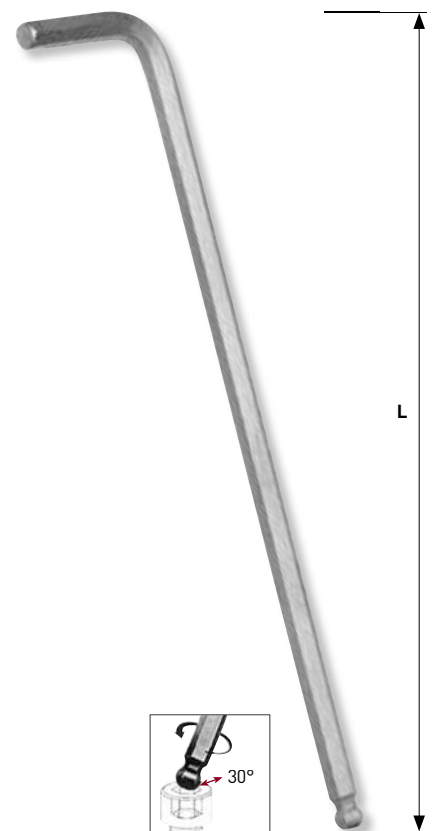

Art.	mm	L mm
3604-1.5	1.5	91.5
3604-2	2.0	102.0
3604-2.5	2.5	114.5
3604-3	3.0	129.0
3604-4	4.0	144.0
3604-5	5.0	165.0
3604-6	6.0	186.0
3604-7	7.0	197.0
3604-8	8.0	208.0
3604-10	10.0	234.0
3606-12	12.0	260.0
3606-14	14.0	294.0
3606-17	17.0	337.0
3606-19	19.0	360.0

DIN / ISO 2936

Kugelpf-Winkelstiftschlüssel-Satz für Innensechskantschrauben
extra lang, poliert und matt verchromt

Jeu de clés mâles coudées à tête sphérique pour vis 6 pans creux

extra longues, polies et chromées satinées

Serie di chiavi maschio esagonali a testa sferica
extra lunghe, lucide e cromate satinatate

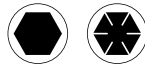

DIN / ISO 2936



Art.	mm
3604	1.5-2-2.5-3-4-5-6-7-8-10

Kugelpf-Winkelstiftschlüssel-Koffer für Innensechskantschrauben
extra lang, poliert und matt verchromt

Coffret de clés mâles coudées à tête sphérique pour vis 6 pans creux

extra longues, polies et chromées satinées

Valigetta di chiavi maschio esagonali a testa sferica

extra lunghe, lucide e cromate satinatate

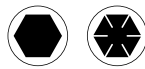
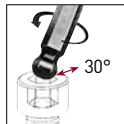

DIN / ISO 2936



360 x 185 x 52 mm

Art.	mm
3606	3-4-5-6-7-8-10-12-14-17

Kugelpf-Winkelstiftschlüssel für Innensechskantschrauben, Zollmasse
extra lang, poliert und matt verchromt

Clé mâle coudée à tête sphérique pour vis 6 pans creux en pouce

extra longue, polie et chromée satinée

Chiave maschio esagonale piegata a testa sferica in pollici
extra lunga, lucida e cromata satinatata

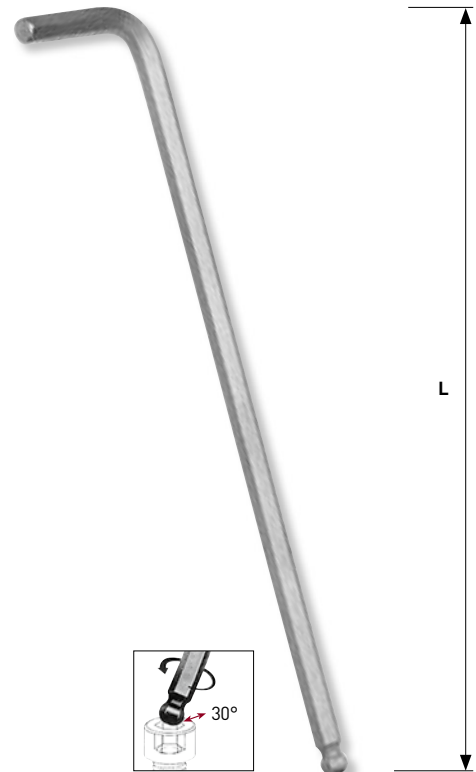
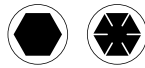

Art.	inch	L mm
3603-1/16	1/16"	92
3603-5/64	5/64"	100
3603-3/32	3/32"	114
3603-1/8	1/8"	130
3603-5/32	5/32"	142
3603-3/16	3/16"	165
3603-1/4	1/4"	185
3603-5/16	5/16"	208
3603-3/8	3/8"	235

Kugelkopf-Winkelstiftschlüssel-Satz für Innensechskantschrauben, Zollmasse
extra lang, poliert und matt verchromt

Jeu de clés mâles coudées à tête sphérique pour vis 6 pans creux en pouce
extra longues, polies et chromées satinées

Serie di chiavi maschio esagonali a testa sferica in pollici

extra lunghe, lucide e cromate satiniate

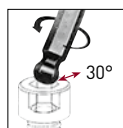

Art.	 inch
3603	1/16"-5/64"-3/32"-1/8"-5/32" 3/16"-1/4"-5/16"-3/8"

Winkelstiftschlüssel für TX-Schrauben

matt verchromt

Clé mâle coudée pour vis TX

chromée satinée

Chiave maschio piegata per viti con impronta TX

cromata satinata



Art.		 mm	L mm
3605-10	T10	2.7	50
3605-15	T15	3.3	55
3605-20	T20	3.8	60
3605-25	T25	4.4	68
3605-27	T27	5.0	75
3605-30	T30	5.5	85
3605-40	T40	6.6	95
3605-45	T45	7.82	110
3605-50	T50	8.83	120



Winkelstiftschlüssel-Satz für TX-Schrauben

matt verchromt

Jeu de clés mâles coudées pour vis TX

chromées satinées

Serie di chiavi maschio piegate per viti con impronta TX

cromate satiniate



Art.	
3605	T10-T15-T20-T25-T27 T30-T40-T45-T50

Winkelstiftschlüssel für TX-Schrauben



extra lang, poliert und matt verchromt

Clé mâle coudée pour vis TX

extra longue, polie et chromée satinée

Chiave maschio piegata per viti con impronta TX

extra lunga, lucida e cromata satinata

Art.		 mm	L mm
3607-10	T10	2.7	93
3607-15	T15	3.3	104
3607-20	T20	3.8	116
3607-25	T25	4.4	131
3607-27	T27	5.0	145
3607-30	T30	5.5	166
3607-40	T40	6.6	187
3607-45	T45	7.82	209
3607-50	T50	8.83	235



Winkelstiftschlüssel-Satz für TX-Schrauben

extra lang, poliert und matt verchromt

Jeu de clés mâles coudées pour vis TX

extra longues, polies et chromées satinées

Serie di chiavi maschio piegate per viti con impronta TX

extra lunghe, lucide e cromate satinata

Art.	
3607	T10-T15-T20-T25-T27 T30-T40-T45-T50





Kugelkopf-Winkelstiftschlüssel für TX-Schrauben

lang, poliert und matt verchromt

*Clé mâle coudée à tête sphérique pour vis TX
longue, polie et chromée satinée*

**Chiave maschio piegata con testa sferica
per viti con impronta TX**

lunga, lucida e cromata satinata

Art.		 mm	L mm
3608-10	T10	2.7	87
3608-15	T15	3.3	92
3608-20	T20	3.8	96
3608-25	T25	4.4	102
3608-27	T27	5.0	110
3608-30	T30	5.5	118
3608-40	T40	6.6	130
3608-45	T45	7.82	137
3608-50	T50	8.83	160



S2
quality

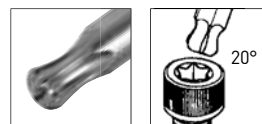
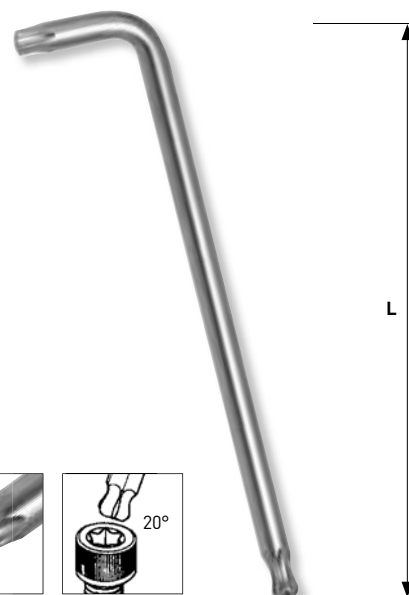

Kugelkopf-Winkelstiftschlüssel-Satz für TX-Schrauben

lang, poliert und matt verchromt

*Jeu de clés mâles coudées à tête sphérique
pour vis TX*

longues, polies et chromées satinées

**Serie di chiavi maschio piegate con testa sferica
per viti con impronta TX**

lunghe, lucide e cromate satinato

Art.	
3608	T10-T15-T20-T25-T27 T30-T40-T45-T50



S2
quality

9
PCS



Winkelstiftschlüssel für TX-Schrauben



mit Bohrung an der Spitze, für TX-Schrauben mit und ohne Sicherungsstift, **extra lang**, poliert und matt verchromt

Clé mâle coudée pour vis TX

avec pointe percée, pour vis TX normales et TX de sécurité, **extra longue**, polie et chromée satinée

Chiave maschio piegata per viti con impronta TX

con perforazione sulla punta, per viti TX normali e viti TX Tamper **extra lunga**, lucida e cromata satinata

Art.		 mm	L mm
3609-10	T10	2.7	93
3609-15	T15	3.3	104
3609-20	T20	3.8	116
3609-25	T25	4.4	131
3609-27	T27	5.0	145
3609-30	T30	5.5	166
3609-40	T40	6.6	187
3609-45	T45	7.82	209
3609-50	T50	8.83	235

Winkelstiftschlüssel-Satz für TX-Schrauben

mit Bohrung an der Spitze, für TX-Schrauben mit und ohne Sicherungsstift, **extra lang**, poliert und matt verchromt

Jeu de clés mâles coudées pour vis TX

avec pointe percée, pour vis TX normales et TX de sécurité, **extra longues**, polies et chromées satinées

Serie di chiavi maschio piegate per viti con impronta TX

con perforazione sulla punta, per viti TX normali e viti TX Tamper **extra lunghe**, lucide e cromate satinata

Art.	
3609	T10-T15-T20-T25-T27 T30-T40-T45-T50

Winkelstiftschlüssel-Satz für TX-Schrauben

mit Bohrung an der Spitze, für TX-Schrauben mit und ohne Sicherungsstift, **extra kurz**, poliert und matt verchromt

Jeu de clés mâles coudées pour vis TX

avec pointe percée, pour vis TX normales et TX de sécurité, **extra courtes**, polies et chromées satinées

Serie di chiavi maschio piegate per viti con impronta TX

con perforazione sulla punta, per viti TX normali e viti TX Tamper **extra corte**, lucide e cromate satinata

Art.	
3609S	T10-T15-T20-T25-T27-T30-T40



Winkelstiftschlüssel-Satz für TX-Schrauben

mit Bohrung an der Spitze, für TX-Schrauben mit und ohne Sicherungsstift

lang, aus rostfreiem Stahl

Jeu de clés mâles coudées pour vis TX

avec pointe percée, pour vis TX normales et TX de sécurité longues, en acier inoxydable

Serie di chiavi maschio piegate per viti con impronta TX

con perforazione sulla punta, per viti TX normali e viti TX Tamper lunghe, in acciaio inossidabile



inox 9 PCS



Art.	
3645	T10-T15-T20-T25-T27-T30-T40-T45-T50

Stiftschlüssel mit T-Griff für Innensechskantschrauben

2 Enden mit Sechskantprofil und 1 Ende mit Kugelkopf-Sechskantprofil

Clé mâle en T pour vis 6 pans creux

2 extrémités à empreinte 6 pans mâle, 1 extrémité à empreinte 6 pans à tête sphérique

Chiave a T maschio esagonale

2 estremità con maschio esagonale e 1 estremità a testa sferica



Art.	mm	L 1 mm	L 2 mm
2593-02	2.0	65	126
2593-025	2.5	65	126
2593-03	3.0	65	126
2593-04	4.0	90	180
2593-05	5.0	90	180
2593-06	6.0	105	210
2593-07	7.0	105	210
2593-08	8.0	125	250
2593-10	10.0	145	300

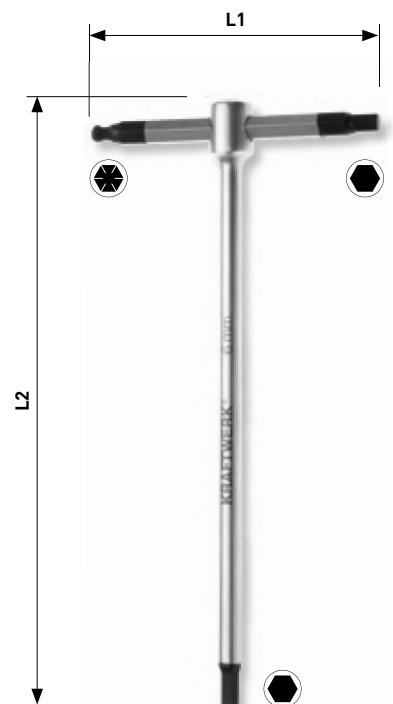

Innensechskant-Doppelgelenk-Schlüssel-Satz
Jeu de clés mâles à double articulation
Set di chiavi maschio esagonale a doppio snodo



CrV

6
PCS



Art.	
3625	3-4-5-6-8-10 mm

TX-Doppelgelenk-Schlüsselsatz
Jeu de clés TX à double articulation
Set di chiavi maschio Torx a doppio snodo



CrV

7
PCS



Art.	
3626	T20-T25-T27-T30-T40-T45-T50

XZN-Vielzahn-Doppelgelenk-Schlüsselsatz
Jeu de clés à denture multiple XZN à double articulation
Set di chiavi maschio XZN a doppio snodo



CrV

5
PCS



Art.	
3627	M4-M5-M6-M8-M10

Stiftschlüssel-Koffer mit T-Griff für Innensechskantschrauben

2 Enden mit Sechskantprofil und 1 Ende mit Kugelkopf-Sechskantprofil

Coffret de clés mâles en T pour vis 6 pans creux

2 extrémités à empreinte 6 pans mâle, 1 extrémité à empreinte 6 pans à tête sphérique

Valigetta di chiavi a T maschio esagonale

2 estremità con maschio esagonale e 1 estremità a testa sferica

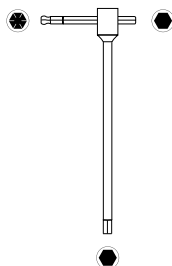
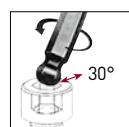

Art. 2593-02	2.0 mm
Art. 2593-025	2.5 mm
Art. 2593-03	3.0 mm
Art. 2593-04	4.0 mm
Art. 2593-05	5.0 mm
Art. 2593-06	6.0 mm
Art. 2593-07	7.0 mm
Art. 2593-08	8.0 mm
Art. 2593-10	10.0 mm

Art.

4900-35K



9
PCS

COMPLETO



421 x 200 x 68 mm

Stiftschlüssel mit T-Griff für TX-Schrauben

2 Enden mit TX-Profil und 1 Ende mit TX-Profil mit Bohrung

Clé mâle en T pour vis TX

2 extrémités à empreinte TX, 1 extrémité à empreinte TX de sécurité

Chiave a T per viti con impronta TX

2 estremità con maschio TX e 1 estremità con TX con foro

Art.	mm	mm	L 1 mm	L 2 mm
2594-10	T10	2.7	65	125
2594-15	T15	3.2	65	125
2594-20	T20	3.8	65	125
2594-25	T25	4.4	90	180
2594-27	T27	4.9	90	180
2594-30	T30	5.5	90	180
2594-40	T40	6.6	105	210
2594-45	T45	7.82	105	210
2594-50	T50	8.83	105	215

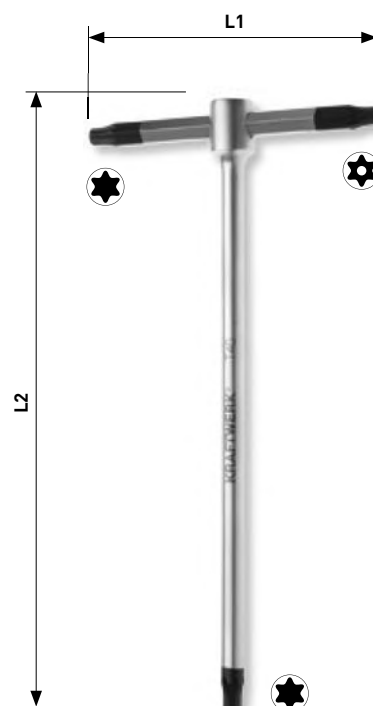

Stiftschlüssel-Koffer mit T-Griff für TX-Schrauben

2 Enden mit TX-Profil und 1 Ende mit TX-Profil mit Bohrung

Coffret de clés mâles en T pour vis TX

2 extrémités à empreinte TX, 1 extrémité à empreinte TX de sécurité

Valigetta di chiavi a T per viti con impronta TX

2 estremità con maschio TX e 1 estremità con TX con foro

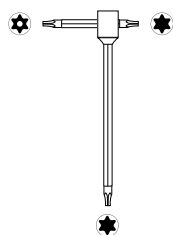

- Art. 2594-10 T10
- Art. 2594-15 T15
- Art. 2594-20 T20
- Art. 2594-25 T25
- Art. 2594-27 T27
- Art. 2594-30 T30
- Art. 2594-40 T40
- Art. 2594-45 T45
- Art. 2594-50 T50

Art.

4900-36K



9
PCS

COMPLETO



421 x 200 x 68 mm

Stiftschlüssel-Satz für Innensechskantschrauben

mit ergonomischem Klapphalter

Jeu de clés mâles pour vis 6 pans creux

sur support ergonomique

Serie di chiavi maschio esagonali

con supporto serramanica



8
PCS



115 x 40 x 40 mm

Art.



mm

3623

1.5-2-2.5-3-4-5-6-8

Stiftschlüssel-Satz für TX-Schrauben

mit ergonomischem Klapphalter

Jeu de clés mâles pour vis TX

sur support ergonomique

Serie di chiavi maschio per viti con impronta TX

con supporto serramanica



8
PCS



115 x 40 x 40 mm

Art.



3624

T9-T10-T15-T20-T25-T27-T30-T40



5
PCS

5 Stk./pzs./pz.

10
PCS

10 Stk./pzs./pz.

25
PCS

25 Stk./pzs./pz.

50
PCS

50 Stk./pzs./pz.

Bit für Schlitzschrauben
Embout pour vis à fente
Inserto per viti a testa con intaglio



C6.3
DIN 3126
ISO 1173



DIN 3127
ISO 2351



5 PCS		
2721-5	0.5	4.0
2722-5	0.6	4.5
2723-5	0.8	5.5
2724-5	1.0	6.0
2725-5	1.2	6.5
2726-5	1.6	8.0

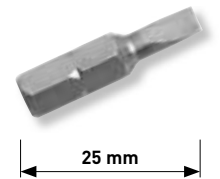

Kreuzschlitz-Bit für Phillips-Schrauben
Embout pour vis Phillips
Inserto per viti con impronta a croce Phillips



C6.3
DIN 3126
ISO 1173



DIN 3128
ISO 8764



5 PCS	10 PCS	50 PCS	
2705-5			PH 0
2701-5	2701-10	2701-50	PH 1
2702-5	2702-10	2702-50	PH 2
2703-5	2703-10		PH 3
2704-5			PH 4

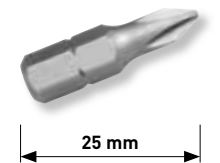

Kreuzschlitz-Bit für Pozidriv-Schrauben
Embout pour vis Pozidriv
Inserto per viti con impronta a croce Pozidriv



C6.3
DIN 3126
ISO 1173



DIN 3128
ISO 8764



5 PCS	10 PCS	50 PCS	
2711-5	2711-10	2711-50	PZ 1
2712-5	2712-10	2712-50	PZ 2
2713-5	2713-10	2713-50	PZ 3
2714-5			PZ 4



Bit für TX-Schrauben

Embouts pour vis TX

Inserto per viti con impronta TX



C6.3
DIN 3126
ISO 1173



5 PES	10 PES	50 PES		 mm
2730-5			T8	2.3
2731-5	2731-10		T10	2.7
2732-5	2732-10	2732-50	T15	3.3
2733-5	2733-10	2733-50	T20	3.8
2734-5	2734-10	2734-50	T25	4.4
2737-5	2737-10		T27	5.0
2735-5	2735-10	2735-50	T30	5.5
2736-5	2736-10	2736-50	T40	6.6
2738-5			T45	7.82
2739-5			T50	8.83

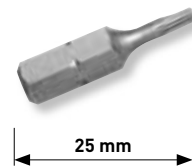

Bit für TX-Schrauben

mit Bohrung an der Spitze, für TX-Schrauben mit und ohne Sicherungsstift

Embout pour vis TX

avec pointe percée, pour vis TX normales et TX de sécurité

Inserto per viti con impronta TX

con perforazione sulla punta, per viti TX normali e viti TX Tamper



C6.3
DIN 3126
ISO 1173



5 PES		 mm
2749-5	T8	2.3
2751-5	T10	2.7
2752-5	T15	3.3
2753-5	T20	3.8
2754-5	T25	4.4
2755-5	T27	5.0
2756-5	T30	5.5
2757-5	T40	6.6

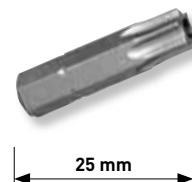

Bit für Innensechskant-Schrauben
Embouts pour vis 6 pans creux
Inserto per viti maschio esagonale



C6.3
DIN 3126
ISO 1173

DIN 7426
ISO 3109

5 PCS	10 PCS	mm
2741-5	2741-10	3.0
2742-5	2742-10	4.0
2743-5	2743-10	5.0
2744-5	2744-10	6.0
2745-5		7.0
2746-5		8.0

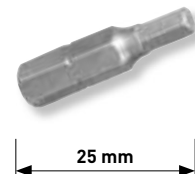

Bit für Innensechskant-Schrauben
mit Bohrung an der Spitze, für Schrauben mit und ohne Sicherungsstift
Embout pour vis 6 pans creux
avec perçage à la pointe, pour vis normales et vis de sécurité
Inserto per viti maschio esagonale
con perforazione sulla punta, per viti normali e viti Tamper



C6.3
DIN 3126
ISO 1173

5 PCS	mm
2676-5	2.0
2677-5	2.5
2678-5	3.0
2679-5	4.0
2680-5	5.0
2681-5	6.0



Bit für Innensechskant-Schrauben Zollmasse
mit Bohrung an der Spitze, für Schrauben mit und ohne Sicherungsstift
Embout pour vis 6 pans creux en pouce
avec pointe percée, pour vis normales et vis de sécurité
Inserto per viti maschio esagonale in pollici
con perforazione sulla punta, per viti normali e viti Tamper



C6.3
DIN 3126
ISO 1173

5 PCS	inch
2683-5	5/32"
2684-5	9/64"
2685-5	1/8"
2686-5	7/64"
2687-5	3/32"
2688-5	5/64"



Bit für Torq-Schrauben

Embout pour vis Torq

Inserto per viti con impronta Torq



C6.3
DIN 3126
ISO 1173



TORQ-
SET



5 PDS	+
2661-5	No. 6
2662-5	No. 8
2663-5	No. 10

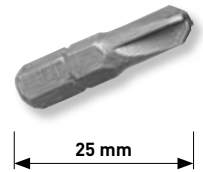

Bit für Tri-Wing-Schrauben

Embout pour vis Tri-Wing

Inserto per viti con impronta Tri-Wing



C6.3
DIN 3126
ISO 1173



TRI-
WING



5 PDS	▲
2671-5	No. 1
2672-5	No. 2
2673-5	No. 3
2674-5	No. 4

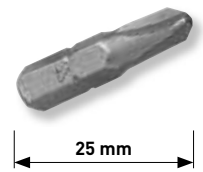

Bit für Spanner-Schrauben

Embout pour vis Spanner

Inserto per viti con impronta Spanner



C6.3
DIN 3126
ISO 1173



SPANNER



5 PDS	⊙
2665-5	No. 4
2667-5	No. 6
2668-5	No. 8
2669-5	No. 10

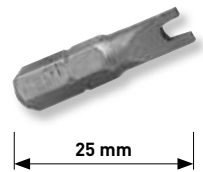

Bit für Robertson Innenvierkant-Schrauben

Embout pour vis 4 pans creux Robertson

Inserto per viti maschio quadro Robertson



C6.3
DIN 3126
ISO 1173



5 PDS	■
2689-5	R1
2696-5	R2

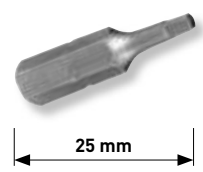

Adapter-Bit für Stecknüsse

Embout adaptateur pour douilles

Inserto adattatore per bussole



C6.3
DIN 3126
ISO 1173



5 PDS	●	■
2770-5	1/4"	1/4"



Bit für Schlitzschrauben

aus rostfreiem Stahl

Embout pour vis à fente

en acier inoxydable

Inserto per viti a testa con intaglio

in acciaio inossidabile



C6.3
DIN 3126
ISO 1173



DIN 3127
ISO 2351

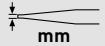
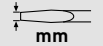

Art.	 mm	 mm
29240	0.8	4.0
29255	0.9	5.5
29265	1.2	6.5
29270	1.6	7.0

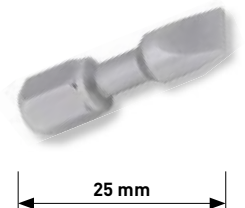

Kreuzschlitz-Bit für Phillips-Schrauben

aus rostfreiem Stahl

Embout pour vis Phillips

en acier inoxydable

Inserto per viti con impronta a croce Phillips

in acciaio inossidabile



C6.3
DIN 3126
ISO 1173



DIN 3128
ISO 8764



Art.	
29000	PH 0
29010	PH 1
29020	PH 2
29030	PH 3



Kreuzschlitz-Bit für Pozidriv-Schrauben

aus rostfreiem Stahl

Embout pour vis Pozidriv

en acier inoxydable

Inserto per viti con impronta a croce Pozidriv

in acciaio inossidabile



C6.3
DIN 3126
ISO 1173



DIN 3128
ISO 8764



Art.	
29100	PZ 0
29110	PZ 1
29120	PZ 2
29130	PZ 3



Bit für TX-Schrauben

aus rostfreiem Stahl

Embout pour vis TX

en acier inoxydable

Inserto per viti con impronta TX

in acciaio inossidabile



C6.3
DIN 3126
ISO 1173

Art.		mm
29310	T10	2.7
29315	T15	3.3
29320	T20	3.8
29325	T25	4.4
29327	T27	5.0
29330	T30	5.5
29340	T40	6.6



Bit für Innensechskant-Schrauben

aus rostfreiem Stahl

Embouts pour vis 6 pans creux

en acier inoxydable

Inserto per viti maschio esagonale

in acciaio inossidabile



C6.3
DIN 3126
ISO 1173

DIN 7426
ISO 3109

Art.	mm
29425	2.5
29430	3.0
29440	4.0
29450	5.0
29460	6.0

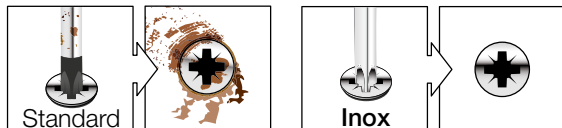
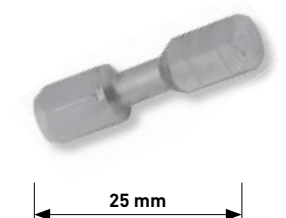

INOX-Werkzeuge – zur Vermeidung von Fremdrost

Outils en Inox pour prévenir la corrosion

Utensili in acciaio inossidabile per prevenire di corrosione

Bit für Schlitzschrauben
Embout pour vis à fente
Inserto per viti a testa con intaglio



E6.3
 DIN 3126
 ISO 1173



DIN 3127
 ISO 2351



5 PCS		
2821-5	0.5	4.0
2822-5	0.6	4.5
2823-5	0.8	5.5
2824-5	1.0	6.0
2825-5	1.2	6.5
2826-5	1.6	8.0

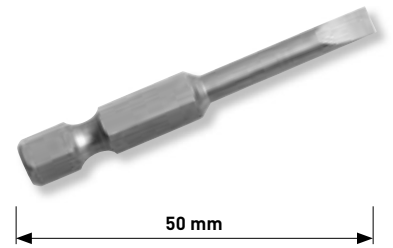

Kreuzschlitz-Bit für Phillips-Schrauben
Embout pour vis Phillips
Inserto per viti con impronta a croce Phillips



E6.3
 DIN 3126
 ISO 1173



DIN 3128
 ISO 8764



5 PCS	10 PCS	25 PCS	
2801-5	2801-10		PH 1
2802-5	2802-10	2802-25	PH 2
2803-5			PH 3
2804-5			PH 4

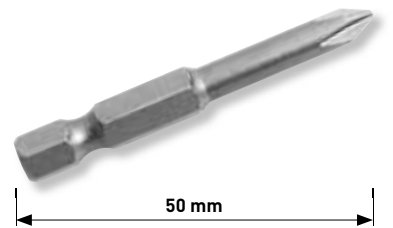

Kreuzschlitz-Bit für Pozidriv-Schrauben
Embout pour vis Pozidriv
Inserto per viti con impronta a croce Pozidriv



E6.3
 DIN 3126
 ISO 1173



DIN 3128
 ISO 8764



5 PCS	10 PCS	25 PCS	
2811-5	2811-10		PZ 1
2812-5	2812-10	2812-25	PZ 2
2813-5			PZ 3
2814-5			PZ 4

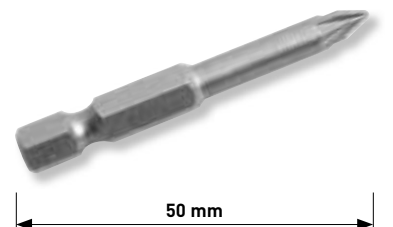

Bit für TX-Schrauben

Embout pour vis TX

Inserto per viti con impronta TX



E6.3
DIN 3126
ISO 1173

5 PCS	10 PCS		
2831-5		T10	2.7
2832-5	2832-10	T15	3.3
2833-5	2833-10	T20	3.8
2834-5	2834-10	T25	4.4
2837-5		T27	5.0
2835-5	2835-10	T30	5.5
2836-5		T40	6.6

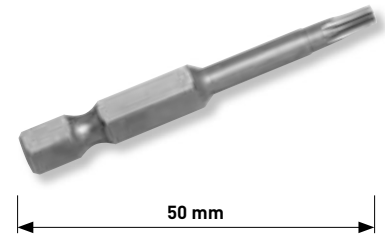

Bit für TX-Schrauben

Embout pour vis TX

Inserto per viti con impronta TX



E6.3
DIN 3126
ISO 1173

10 PCS		
2861	T10	2.7
2862	T15	3.3
2863	T20	3.8
2864	T25	4.4
2865	T27	5.0
2866	T30	5.5
2867	T40	6.6

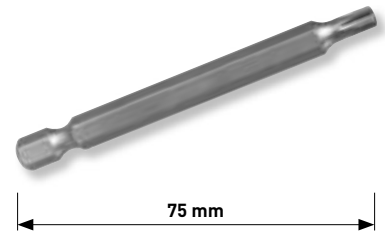

Bit für Innensechskant-Schrauben

Embout pour vis 6 pans creux

Inserto per viti maschio esagonale



E6.3
DIN 3126
ISO 1173

DIN 7426
ISO 3109

5 PCS	
2841-5	3
2842-5	4
2843-5	5
2844-5	6
2845-5	7
2846-5	8

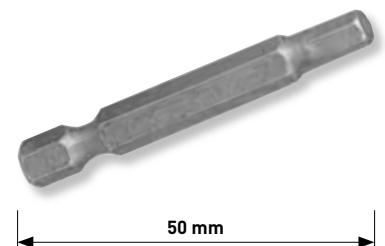

Bit für Robertson Innenvierkant-Schrauben
Embout pour vis 4 pans creux Robertson
 Inserto per viti maschio quadro Robertson

2690-5	R1
2697-5	R2

E6.3
 DIN 3126
 ISO 1173

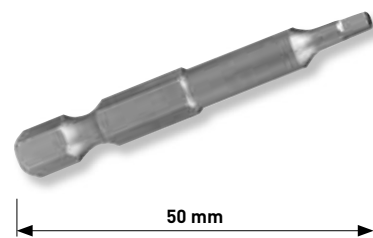

Adapter-Bit für Stecknüsse
Embout adaptateur pour douilles
 Inserto adattatore per bussole

2850-5	1/4"	1/4"

E6.3
 DIN 3126
 ISO 1173

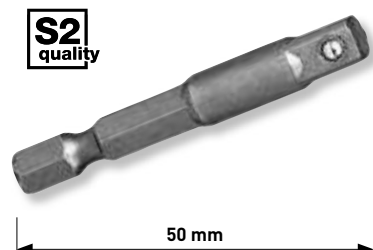

Adapter-Bit für Stecknüsse
Embout adaptateur pour douilles
 Inserto adattatore per bussole

2860-5	1/4"	3/8"

E6.3
 DIN 3126
 ISO 1173

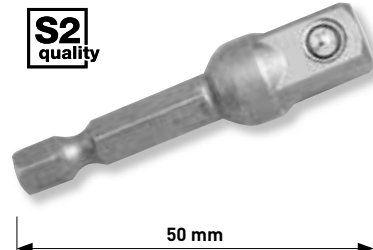

Stecknuss-Bit mit Dauermagnet
Douille magnétique
 Inserto magnetico per teste esagonali

Art.	mm
3784-07	7
3784-08	8
3784-10	10
3784-13	13

E6.3
 DIN 3126
 ISO 1173

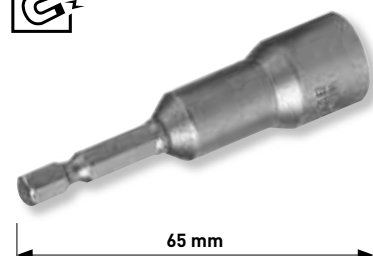

Eindrehwerkzeug für Stockschrauben mit Innengewinde
Embout pour vissage de vis à double filetage
 Inserto filettato per viti senza testa

Art.	
3784-M6	M6
3784-M8	M8
3784-M10	M10
3784-M12	M12



E6.3
 DIN 3126
 ISO 1173



Bit für Schlitzschrauben

Embout pour vis à fente

Inserto per viti a testa con intaglio

Art.	 mm	 mm
302055	0.8	5.5
302065	1.0	6.5
302080	1.2	8.0
302100	1.6	10.0
302120	2.0	12.0



DIN 3126-D8
ISO 1173



DIN 3127
ISO 2351

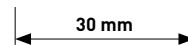

Kreuzschlitz-Bit für Phillips-Schrauben

Embout pour vis Phillips

Inserto per viti con impronta a croce Phillips

Art.	
303001	PH 1
303002	PH 2
303003	PH 3
303004	PH 4



DIN 3126-D8
ISO 1173



DIN 3128
ISO 8764

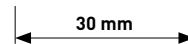
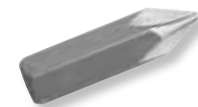

Kreuzschlitz-Bit für Phillips-Schrauben

Embout pour vis Phillips

Inserto per viti con impronta a croce Phillips

Art.	
313001	PH 1
313002	PH 2
313003	PH 3



DIN 3126-D8
ISO 1173



DIN 3128
ISO 8764

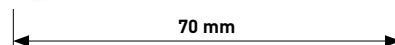
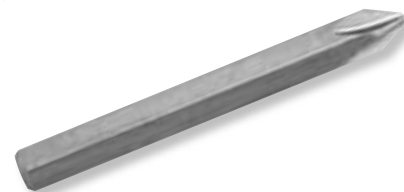

Kreuzschlitz-Bit für Pozidriv-Schrauben

Embout pour vis Pozidriv

Inserto per viti con impronta a croce Pozidriv

Art.	
304001	PZ 1
304002	PZ 2
304003	PZ 3
304004	PZ 4



DIN 3126-D8
ISO 1173



DIN 3128
ISO 8764



Kreuzschlitz-Bit für Pozidriv-Schrauben
Embout pour vis Pozidriv
Inserto per viti con impronta a croce Pozidriv



DIN 3126-D8
ISO 1173



DIN 3128
ISO 8764

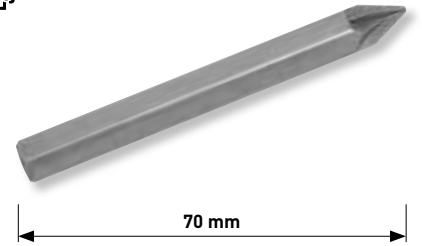

Art.	
314001	PZ 1
314002	PZ 2

Bit für TX-Schrauben
Embout pour vis TX
Inserto per viti con impronta TX



DIN 3126-D8
ISO 1173

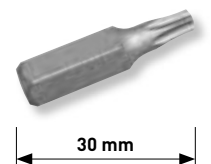

Art.		 mm
305010	T10	2.7
305015	T15	3.3
305020	T20	3.8
305025	T25	4.4
305027	T27	5.0
305030	T30	5.5
305040	T40	6.6
305045	T45	7.82
305047	T47	8.1
305050	T50	8.83
305055	T55	11.22
305060	T60	13.25
305070	T70	15.51
305080	T80	17.54
305090	T90	19.92
305100	T100	22.13

Bit für TX-Schrauben

Embout pour vis TX

Inserto per viti con impronta TX



DIN 3126-D8
ISO 1173



Art.		 mm
315015	T15	3.3
315020	T20	3.8
315025	T25	4.4
315027	T27	5.0
315030	T30	5.5
315040	T40	6.6
315045	T45	7.82
315050	T50	8.83
315055	T55	11.22
315060	T60	13.25
315070	T70	15.51
315080	T80	17.54
315090	T90	19.92
315100	T100	22.13

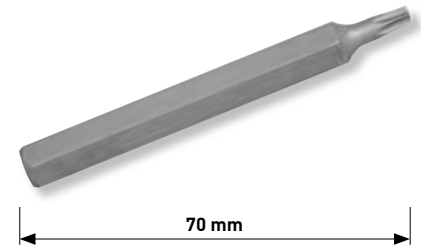

Bit für TX-Schrauben

mit Bohrung an der Spitze, für TX-Schrauben mit und ohne Sicherungsstift

Embout pour vis TX

avec pointe percée, pour vis TX normales et TX vis de sécurité

Inserto per viti con impronta TX

con perforazione sulla punta, per viti TX normali e viti TX Tamper



DIN 3126-D8
ISO 1173



Art.		 mm
305310	T10	2.7
305315	T15	3.3
305320	T20	3.8
305325	T25	4.4
305327	T27	5.0
305330	T30	5.5
305340	T40	6.6
305345	T45	7.82
305350	T50	8.83
305355	T55	11.22
305360	T60	13.25
305370	T70	15.51

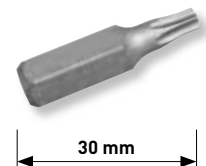

Bit für TX-Schrauben

mit Bohrung an der Spitze, für TX-Schrauben mit und ohne Sicherungsstift

Embout pour vis TX

avec pointe percée, pour vis TX normales et TX de sécurité

Inserto per viti con impronta TX

con perforazione sulla punta, per viti TX normali e viti TX Tamper



DIN 3126-D8
ISO 1173

Art.		 mm
315320	T20	3.8
315325	T25	4.4
315327	T27	5.0
315330	T30	5.5
315340	T40	6.6
315345	T45	7.82
315350	T50	8.83
315355	T55	11.22
315360	T60	13.25

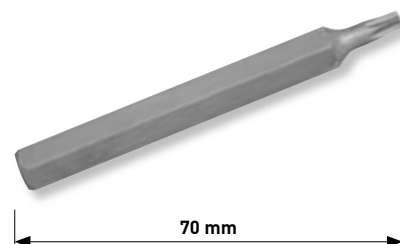

Bit für Innensechskant-Schrauben

Embout pour vis 6 pans creux

Inserto per viti maschio esagonale



DIN 3126-D8
ISO 1173

DIN 7426
ISO 3109

Art.	 mm
306003	3
306004	4
306005	5
306006	6
306007	7
306008	8
306010	10
306012	12
306014	14

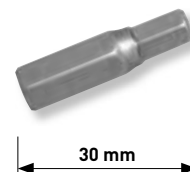

Bit für Innensechskant-Schrauben

Embout pour vis 6 pans creux

Inserto per viti maschio esagonale



DIN 3126-D8
ISO 1173

DIN 7426
ISO 3109

Art.	 mm
316004	4
316005	5
316006	6
316007	7
316008	8
316010	10
316012	12

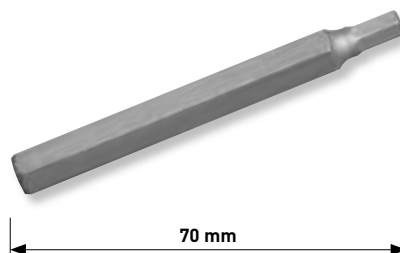

Bit für Innensechskant-Schrauben Zollmasse

Embout pour vis 6 pans creux en pouce

Inserto per viti maschio esagonale in pollici

Art.	inch
306501	1/8"
306502	5/32"
306503	3/16"
306504	7/32"
306505	1/4"
306507	5/16"
306509	3/8"



DIN 3126-D8
ISO 1173

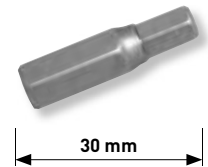

Bit für XZN Vielzahn-Schrauben

Embout pour vis à denture multiple XZN

Inserto maschio per viti con impronta multidentati interni XZN

Art.	XZN
348005	M5
348006	M6
348008	M8
348010	M10
348012	M12



DIN 3126-D8
ISO 1173

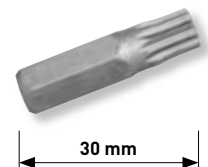

Bit für XZN Vielzahn-Schrauben

Embout pour vis à denture multiple XZN

Inserto maschio per viti con impronta multidentati interni XZN

Art.	XZN
349005	M5
349006	M6
349008	M8
349010	M10
349012	M12



DIN 3126-D8
ISO 1173

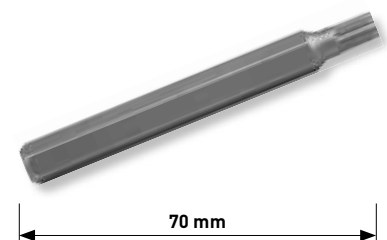

Schlag-Bit für Schlitzschrauben

Embout impact pour vis à fente

Inserto ad impatto per viti a testa con intaglio

Art.	mm	mm
2035F06	1.0	6
2035F08	1.2	8
2035F10	1.6	10
2035F12	2.0	12



DIN 3126-D8
ISO 1173

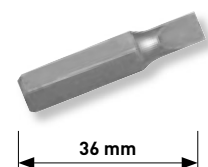

Kreuzschlitz-Schlag-Bit für Phillips-Schrauben
Embout impact pour vis Phillips
Inserto ad impatto per viti con impronta a croce Phillips



Art.	+
2035PH1	PH 1
2035PH2	PH 2
2035PH3	PH 3
2035PH4	PH 4

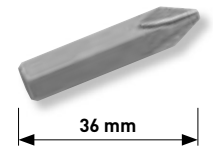

Schlag-Bit für TX-Schrauben
Embout impact pour vis TX
Inserto ad impatto per viti con impronta TX

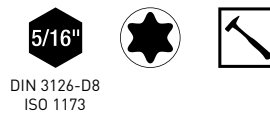

Art.	★
2035T30	T30
2035T40	T40
2035T45	T45
2035T50	T50

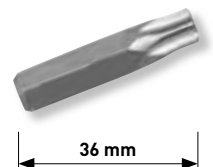

Adapter-Schlag-Bit für Stecknüsse
Embout impact adaptateur pour douilles
Inserto ad impatto adattatore per bussole



Art.	●	■
2035B38	5/16"	3/8"

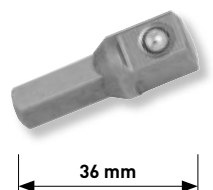

Bit-Adapter
Douille porte-embouts
Bussola portainseriti



Art.	○	○
2760	1/4"	1/4"

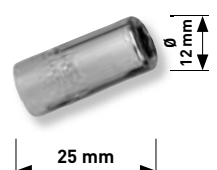



Bit-Adapter

Douille porte-embouts

Bussola portainseriti



Art.			L mm
2761	3/8"	1/4"	27
211516	3/8"	5/16"	29
311516	1/2"	5/16"	38

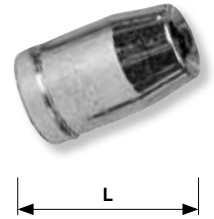



Schlag-Bit-Adapter

Douille porte-embouts impact

Bussola portainseriti ad impatto



Art.		
2035A12	1/2"	5/16"

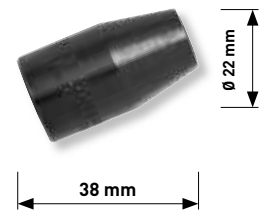



Bit-Adapter

Adaptateur pour embouts

Adattatore portainseriti



Art.		
2694	10mm	1/4"



CLICKRAFT





Universal-Bit-Magnethalter

Porte-embouts magnétique

Portainseriti magnetico



Art.			L mm
2750	1/4"	1/4"	60
2750-1	1/4"	1/4"	60
2764	1/4"	1/4"	142



inox

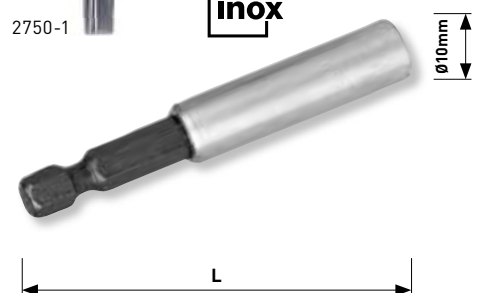

Bit-Justier-Magnethalter
Porte-embouts magnétique à ajustage
Portainseriti magnetico regolabile



Art.			L mm
3750	1/4"	1/4"	58
3760	5/16"	5/16"	75

Bit-Schnellwechsel-Magnethalter
Porte-embouts magnétique à changement rapide
Portainseriti magnetico a sgancio rapido

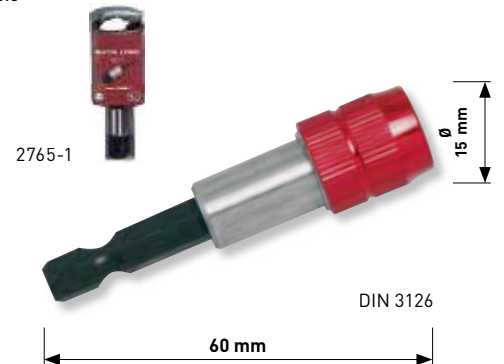

Art.		
2765	1/4"	1/4"
2765-1	1/4"	1/4"

Bit-Schnellwechsel-Magnethalter
 mit Auswurfknopf
Porte-embouts magnétique à changement rapide
 avec bouton d'éjection
Portainseriti magnetico a sgancio rapido
 con pulsante d'espulsione



Art.		
3764	1/4"	1/4"
3764-1	1/4"	1/4"

Bit-Schnellwechsel-Magnethalter
Porte-embouts magnétique à changement rapide
Portainseriti magnetico a sgancio rapido

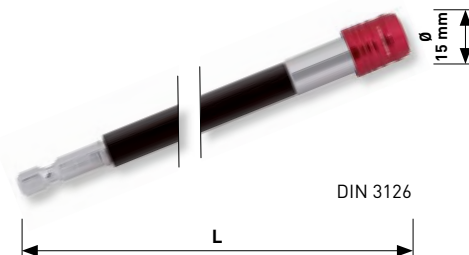

Art.	⬠	○	L mm
3766	1/4"	1/4"	150
3767	1/4"	1/4"	300
3768	1/4"	1/4"	450
3769	1/4"	1/4"	600

Flexible Verlängerung für Bits
Rallonge flexible pour embouts
Prolunga flessibile per inserti

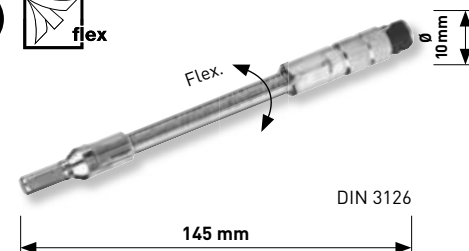

Art.	⬠	○
107140	1/4"	1/4"

Winkelschraub-Vorsatz
Porte-embouts de vissage d'angle
Portainseriti angolare

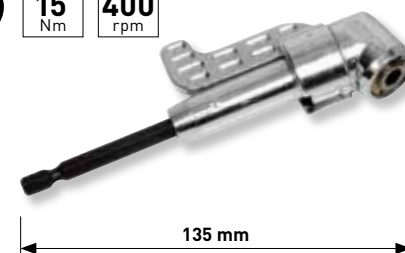
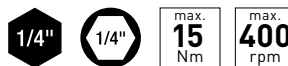

Art.	⬠	○
2768	1/4"	1/4"

Ratschen-Bit-Schraubendreher
kurz

Tournevis à cliquet porte-embouts
court

Impugnatura portainseriti a cricchetto
corta



ERGOKRAFT



Art.	○
4133B	1/4"

Drehmoment-Bit-Schraubendreher
Tournevis porte-embouts dynamométrique
 Giravite dinamometrico per inserti

1-4 Nm A +/- 4 %



Art.	○	Nm ←->
2039	1/4"	1-4



Feinzahn-Bit-Umschaltknarre
Cliquet réversible d'embouts à denture fine
 Chiave a cricchetto reversibile a denti fini per inserti



Art.	○
3799	1/4"



Mini-Bit-Umschaltknarre
Cliquet réversible d'embouts mini
 Mini chiave a cricchetto reversibile per inserti



Art.	○
2700	1/4"



Feinzahn-Bit-Knarre

zweiseitig umschaltbar, 15° abgewinkelt, zur direkten Aufnahme von 1/4" + 5/16" Bits

Cliquet d'embouts à denture fine

réversible de 2 côtés, coudé à 15°, pour l'adaptation directe des embouts 1/4" et 5/16"

Chiave a cricchetto a denti fini per inserti

due teste reversibili, inclinato di 15°, per l'adattazione diretta di inserti 1/4" e 5/16"

Art.	○	○
4070	1/4"	5/16"

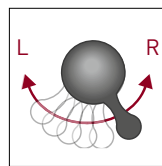
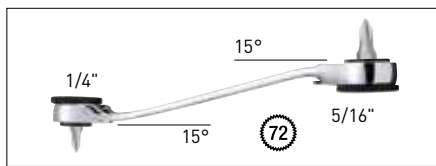

Bit-Satz für TX-Schrauben

mit Bohrung an der Spitze, für TX-Schrauben mit und ohne Sicherungsstift

Jeu d'embouts pour vis TX

avec pointe percée, pour vis TX normales et TX de sécurité

Serie di inserti per viti con impronta TX

con perforazione sulla punta, per viti TX normali e viti TX Tamper

Art.	●	⚙	
2758	1/4"	T10-T15-T20-T25-T27-T30-T40	25 mm

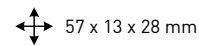
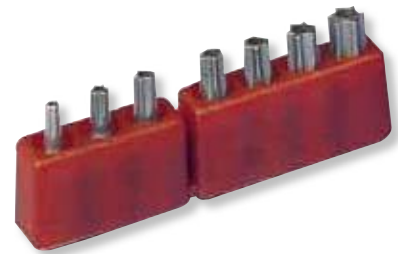

Rund-Bit-Box

Boîte ronde d'embouts

Box rotonda d'inserti

- 2 PZ 1-2
- 7 T10-T15-T20-T25-T27-T30-T40
- 4 mm



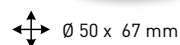

Art. 2750

Art.	●	
2780	1/4"	25 mm





Universal-Rund-Bit-Box
Boîte ronde d'embouts universels
Box rotonda d'inserti universale

1/4" S2 quality 11 PCS

- 3  4.5-5.5-6.5 mm
- 3  PH 1-2-3
- 2  PZ 1-2
- 2  4-5 mm

 Art. 2750





Art.		
2783	1/4"	25 mm





± Ø 50 x 67 mm

Universal-Rund-Bit-Box
Boîte ronde d'embouts universels
Box rotonda d'inserti universale

1/4" S2 quality 19 PCS

- 2  4-5.5-6.5 mm
- 2  PH 1-2
- 3  PZ 1-2-3
- 6  T10-T15-T20-T25-T30-T40
- 4  3-4-5-6 mm

 Art. 2750





Art.		
2786	1/4"	25 mm



± Ø 81 x 50 mm

Universal-Rund-Bit-Box
Boîte ronde d'embouts universels
Box rotonda d'inserti universale

1/4" S2 quality 19 PCS

- 3  4-5.5-6.5 mm
- 2  PH 1-2
- 3  PZ 1-2-3
- 6  T10-T15-T20-T25-T30-T40
- 4  3-4-5-6 mm

  Art. 2750

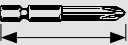
Art.		
2790	1/4"	50 mm



± Ø 83 x 60 mm

Aluminium-Bit-Box







mit der TX- und Pozidriv-Bit-Doppelbestückung

Boîte aluminium d'embouts

avec composition doublée en TX et Pozidriv

Box d'inserti in alluminio



con doppio allestimento di inserti Torx e Pozidriv

- 3  4-4.5-5.5 mm
- 3  PH 1-2-3
- 6  2xPZ1 - 2xPZ2 - 2xPZ3
- 12  T10 - T15 - 2xT20 - 2xT25 - 2xT27 - 2xT30 - 2xT40
- 6  T10-T15-T20-T25-T27-T30
- 4  3-4-5-6 mm



Art. 3782-1



Art.		
3782-1	1/4"	25 mm



C6.3

DIN 3126
ISO 1173



Alu

105 x 78 x 34 mm

Bit-Box

mit 6 farblich unterscheidenden TX-Bits und Bit-Schnellwechsel-Magnethalter

Boîte d'embouts

avec 6 embouts TX de couleur facilitant leur identification et porte-embouts magnétique à changement rapide

Box d'inserti

da 6 inserti TX colorati per facilitarne l'identificazione e con portainseriti magnetico a sgancio rapido



- 6  T10-T15-T20-T25-T30-T40



Art. 99049



Art.		
99049	1/4"	25 mm



C6.3

DIN 3126
ISO 1173



68 x 65 x 20 mm

Bit-Box





mit Bit-Schnellwechsel-Magnethalter

Boîte d'embouts

avec porte-embouts magnétique à changement rapide



Box d'inserti

con portainseriti magnetico a sgancio rapido

- 6  4-4.5-5.5-6-6.5-8 mm
- 3  PH 1-2-3
- 6  2xPZ1 - 2xPZ2 - 2xPZ3
- 12  2xT10 - 2xT15 - 2xT20 - 2xT25 - 2xT30 - 2xT40
- 4  3-4-5-6 mm



Art. 2765

Art.		
3788	1/4"	25 mm



C6.3

DIN 3126
ISO 1173



101 x 56 x 30 mm

Bit-Werkzeug-Satz

mit schlanker Bit-Umschaltknarre. Speziell geeignet fürs Fahrrad.









Jeu d'embouts

avec cliquet d'embouts réversible fin. Spécial Cycles.



Assortimento d'inserti

con sottile chiave a cricchetto. Specialmente adatto per biciclette.



- 1  5 mm
- 1  PH2
- 1  T20
- 6  2-2.5-3-4-5-6 mm
-  1/4"  1/4"
-  1/4"  1/4"



Art.		
3776	1/4"	25 mm

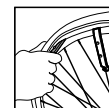

2x

Universal-Bit-Box







mit Bit-Schnellwechsel-Magnethalter

Boîte d'embouts universels

avec porte-embouts magnétique à changement rapide



Box d'inserti universale

con portainseriti magnetico a sgancio rapido

- 6  4-4.5-5.5-6-6.5-8 mm
- 3  PH 1-2-3
- 3  PZ 1-2-3
- 6  T10-T15-T20-T25-T30-T40
- 6  T10-T15-T20-T25-T30-T40
- 4  3-4-5-6 mm



Art. 2765

Art.		
3789	1/4"	25 mm



C6.3

DIN 3126
ISO 1173



101 x 56 x 30 mm

Spezial-Bit-Box

mit Sicherheits-Bits für alle gängigen Sicherheitsschrauben und Bit-Schnellwechsel-Magnethalter

Boîte d'embouts spéciaux

avec embouts de sécurité pour les vis de sécurité courantes et avec porte-embouts magnétique à changement rapide

Box d'inserti speciali

con inserti di sicurezza per tutti viti di sicurezza comune e con portainseriti magnetico a sgancio rapido

- 9 T8-T10-T15-T20-T25-T27-T30-T35-T40
- 6 2-2.5-3-4-5-6 mm
- 6 5/64"-3/32"-7/64"-1/8"-9/64"-5/32"
- 3 Nos. 6-8-10
- 4 Nos. 1-2-3-4
- 4 Nos. 4-6-8-10

Art. 2765

Art.		
3786	1/4"	25 mm

1/4"

S2
quality

33
PCS

C6.3

DIN 3126
ISO 1173



101 x 56 x 30 mm

Bit-Box

aus rostfreiem Stahl mit Bit-Schnellwechsel-Magnethalter

Boîte d'embouts

en acier inoxydable, avec porte-embouts magnétique à changement rapide

Box d'inserti

in acciaio inossidabile, con portainseriti magnetico a sgancio rapido

- 3 4-5.5-6.5 mm
- 4 PH1 - 2xPH2 - PH3
- 6 2xPZ1 - 3xPZ2 - PZ3
- 14 2xT10 - 2xT15 - 2xT20 - 2xT25 - 2xT27 - 2xT30 - 2xT40
- 4 3-4-5-6 mm

Art. 2765

Art.		
3796	1/4"	25 mm

1/4"

inox

33
PCS

C6.3

DIN 3126
ISO 1173



103 x 56 x 30 mm

Universal-Bit-Box







mit Bit-Schnellwechsel-Magnethalter

Boîte d'embouts universels

avec porte-embouts magnétique à changement rapide



Box d'inserti universale

con portainseriti magnetico a sgancio rapido

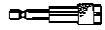
- 6  4-4.5-5.5-6-6.5-8 mm
- 5  PH1 - 2xPH2 - PH3 - PH4
- 6  2xPZ1 - 2xPZ2 - PZ3 - PZ4
- 30  3xT10 - 3xT15 - 6xT20 - 6xT25 - 6xT30 - 6xT40
- 7  T10-T15-T20-T25-T27-T30-T40
- 6  3-4-5-6-7-8 mm



Art. 2765

Art.		
3787	1/4"	25 mm



C6.3

DIN 3126
ISO 1173



 101 x 90 x 32 mm

Universal-Bit-Box











mit Bit-Schnellwechsel-Magnethalter

Boîte d'embouts universels

avec porte-embouts magnétique à changement rapide



Box d'inserti universale

con portainseriti magnetico a sgancio rapido

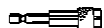
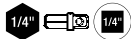
- 6  4-4.5-5.5-6-6.5-8 mm
- 4  PH 1-2-3-4
- 4  PZ 1-2-3-4
- 8  T8-T10-T15-T20-T25-T27-T30-T40
- 8  T8-T10-T15-T20-T25-T27-T30-T40
- 6  3-4-5-6-7-8 mm
- 6  2-2.5-3-4-5-6 mm
- 6  5/64"-3/32"-7/64"-1/8"-9/64"-5/32"
- 4  Nos. 1-2-3-4
- 3  Nos. 6-8-10
- 4  Nos. 4-6-8-10



Art. 2765

Art.		
3777	1/4"	25 mm



C6.3

DIN 3126
ISO 1173



 101 x 90 x 32 mm

Bit-Box







Zweikomponenten-Kassette, mit speziellem Bit-Schnellwechsel-Magnethalter und Inox-Bit-Magnethalter

Boîte d'embouts

avec boîte bi-matière et porte-embouts magnétique spécial à changement rapide et porte-embouts magnétique inox



Box d'inserti

Pratica custodia bimatereale, con due porta inserti, uno in acciaio inox e l'altro con aggancio magnetico a rilascio rapido



- 4  4-5.5-6-6.5 mm
- 5  PH0 - PH1 - 2xPH2 - PH3
- 4  PZ1 - 2xPZ2 - PZ3
- 11  T10 - 2xT15 - 2xT20 - 2xT25 - T27 - 2xT30 - T40
- 7  T10-T15-T20-T25-T27-T30-T40
- 4  3-4-5-6 mm



  Art. 3765 

  Art. 2750



Art.		
3795	1/4"	25 mm



C6.3

DIN 3126
ISO 1173



 129 x 72 x 35 mm

Langbit-Box





Zweikomponenten-Kassette, mit 50 mm langen Bits

Boîte d'embouts longs

avec boîte bi-matière et embouts de longueur 50 mm

Box d'inserti lunghi

Pratica custodia bimatereale, con inserti di lunghezza 50 mm

- 3  4.5-5.5-6.5 mm
- 2  PH 1-2
- 4  PZ1 - 2xPZ2 - PZ3
- 10  T10 - T15 - 2xT20 - 2xT25 - T27 - 2xT30 - T40
- 4  3-4-5-6 mm

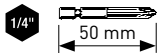

Art.		
3794	1/4"	50 mm



E6.3

DIN 3126
ISO 1173



 129 x 72 x 35 mm

Universal-Bit-Box

mit sämtlichen gängigen, speziellen und Sicherheits-Bits,
Bit-Schraubendreher mit 2-Komponentengriff

Boîte d'embouts universels

avec tous les embouts courants, spéciaux et embouts de sécurité.
Tournevis porte-embouts avec manche bi-matière

Assortimento d'inserti universale

per azionare tutti i tipi di impronta sia speciali che di sicurezza.
Corredato di giravite universale dotato di impugnatura bimatériale



C6.3 E6.3

DIN 3126
ISO 1173

ERGOKRAFT



- 6 4-4.5-5.5-6-6.5-8 mm
- 6 2xPH1 - 2xPH2 - 2xPH3
- 6 2xPZ1 - 2xPZ2 - 2xPZ3
- 28 2xT8 - 2xT10 - 2xT15 - 5xT20 - 6xT25 - 3xT27 - 4xT30 - 4xT40
- 16 2xT8 - 2xT10 - 2xT15 - 2xT20 - 2xT25 - 2xT27 - 2xT30 - 2xT40
- 15 TS10 - 2xTS15 - 2xTS20 - 3xTS25 - 2xTS27 - 3xTS30 - 2xTS40
- 5 3-4-5-6-8 mm
- 3 3-4-5 mm
- 3 Nos. 6-8-10
- 3 Nos. 1-2-3
- 4 Nos. 4-6-8-10
- 2 Nos. 1-2
- 3 M5-M6-M8
- 4 Nos. 1-2-3-4

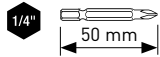

- 3 4-5.5-6.5 mm
- 3 PH 1-2-3
- 3 PZ 1-2-3
- 7 T10-T15-T20-T25-T27-T30-T40
- 2 3-6 mm
- Art. 2750
- Art. 2750



220 x 150 x 45 mm

10 4-5-6-7-8-9-10-11-12-13 mm

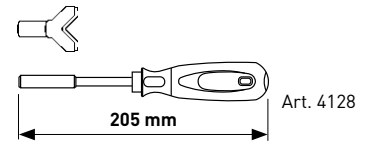

Art.			
2778	1/4"	25 mm	50 mm

Universal-Schraub-Bit-Satz

mit 2 Bit-Magnethaltern in solidem 2-Komponenten-Kasten. Umschaltbarer Ratschen-Bit-Schraubendreher mit abwinkelbarem Kopf (Igerade Form/Pistolenform) wird mitgeliefert.

Jeu d'embouts universels

avec 2 porte-embouts magnétiques dans coffret bi-matière, inclus tournevis d'embouts à cliquet réversible pour utilisation en poignée droite ou revolver

Set universale d'inserti

con 2 portainseriti magnetici in custodia bimatereale. Fornite con impugnatura a cricchetto reversibile, doppia posizione dritto/pistola

- | | | | |
|--|----|--|---|
| | 14 | | 7x4mm - 7x6mm |
| | 21 | | 7xPH1 - 7xPH2 - 7xPH3 |
| | 21 | | 7xPZ1 - 7xPZ2 - 7xPZ3 |
| | 14 | | 2xT10 - 2xT15 - 2xT20 - 2xT25 - 2xT27 - 2xT30 - 2xT40 |
| | 7 | | T10-T15-T20-T25-T27-T30-T40 |
| | 21 | | 7x4mm - 7x5mm - 7x6mm |

- | | | | | | |
|--|---|--|-------------------------------|--|------|
| | 3 | | 3xPH2 | | 1/4" |
| | 3 | | 3xPZ2 | | 1/4" |
| | 7 | | T10 - T15 - 3xT20 - T25 - T30 | | 1/4" |

Art.			
99068	1/4"	25 mm	75 mm

1/4" **1/4"** **S2 quality** **114 PCS**
C6.3 E6.3
DIN 3126
ISO 1173

ERGOKRAFT



204 x 118 x 44 mm



180 mm

TRIBIT-Werkzeug-Satz

mit der TRIBIT-Umschaltknarre, zweiseitig umschaltbar, 15° abgewinkelt, zur direkten Aufnahme von 1/4" + 5/16" Bits und 1/4" Steckschlüssel-Einsätzen. Universell bestückt mit 53 Bits und Stecknuss-Adapter 1/4".

Coffret d'outils TRIBIT

avec le cliquet TRIBIT, réversible de 2 côtés, coudé à 15° pour l'adaptation directe des embouts 1/4" et 5/16" et douilles 1/4". Jeu composé de 53 embouts et adaptateur pour douilles 1/4".

Assortimento inserti TRIBIT

con cricchetto di due teste reversibili, inclinato di 15°, per l'adattamento diretto d'inserti 1/4" e 5/16" e chiavi a bussola 1/4". Completo di 53 inserti ed inserto adattatore per bussola 1/4".

- | | | | | | | | |
|--|---|--|----------------------------|--|---|--|---------------------|
| | 3 | | 4-5.5-6.5 mm | | 3 | | 8-10-12 mm |
| | 3 | | PH 0-1-2 | | 2 | | PH 3-4 |
| | 3 | | PZ 0-1-2 | | 2 | | PZ 3-4 |
| | 7 | | T8-T10-T15-T20-T25-T27-T30 | | 5 | | T40-T45-T50-T55-T60 |
| | 7 | | T8-T10-T15-T20-T25-T27-T30 | | 5 | | T40-T45-T50-T55-T60 |
| | 6 | | 3-4-5-6-7-8 mm | | 3 | | 10-12-14 mm |
| | | | 5/16" | | 4 | | M6-M8-M10-M12 |

Art.	
4072	1/4" + 5/16"

1/4" **5/16"** **72** **S2 quality** **55 PCS**
C6.3 DIN 3126-D8
ISO 1173
DIN 3126
ISO 1173



163 x 80 x 35 mm

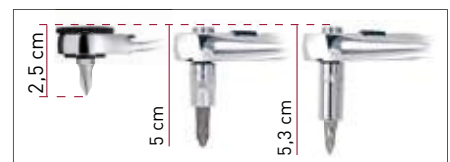
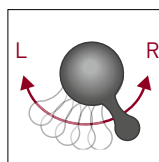
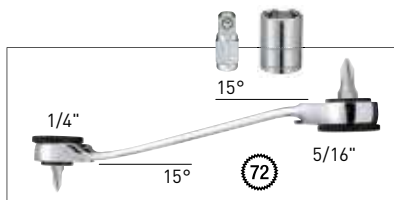

Spezial-Bit- und Stecknuss-Satz



















für TX-, XZN-Aussenviezahn und RIBE-Schrauben

Jeu de douilles et embouts spéciaux



pour vis TX, denture multiple XZN et RIBE

Set di chiavi a bussola ed inserti speciali

per viti TX, XZN e RIBE

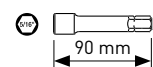
- | | | | | |
|---|---|---|---|-------------------------|
|  |  | 3 |  | E6-E7-E8 |
|  |  | 6 |  | E10-E11-E12-E14-E16-E18 |
|  |  | |  | |
|  |  | |  | |
-
- | | | | | |
|---|---|----|---|-------------------------------------|
|  |  | 10 |  | T10-T15-T20-T25-T27-T30-T40-T45-T50 |
| |  | 5 |  | M4-M6-M8-M10-M12 |
| |  | 10 |  | M4-M5-M6-M7-M8-M9-M10-M12-M13-M14 |



Art.		
3792	5/16"	30 mm



DIN 3126-D8
ISO 1173



221 x 114 x 45 mm

Handschlagschrauber-Satz



zum Lösen von festsitzenden oder angerosteten Schrauben und Muttern

Jeu de tournevis à frapper

pour desserrer facilement les vis et écrous bloqués ou rouillés

Set di cacciaviti a percussione

per svitare facilmente le viti e i dadi bloccati o arrugginiti

- | | | |
|---|---|-----------------|
| 4 |  | 6-8-10-12 mm |
| 4 |  | PH 1-2-3-4 |
| 4 |  | T30-T40-T45-T50 |

 Art. 2035A12

 Art. 2035B38

Art.		
2035	5/16"	36 mm



DIN 3126-D8
ISO 1173



216 x 102 x 58 mm

Handschlagschrauber

zu Satz 2035

Tournevis à frapper

pour coffret 2035

Giravite a percussione

per set 2035

Art.		L mm
2035S	1/2"	143

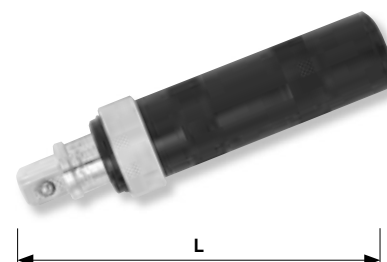

Handschlagschrauber-Satz

zum Lösen von festsitzenden oder angerosteten Schrauben und Muttern

Jeu de tournevis à frapper

pour desserrer facilement les vis et écrous bloqués ou rouillés

Set di cacciaviti a percussione

per svitare facilmente le viti e i dadi bloccati o arrugginiti

- 5/16"  4  6-8-10-12 mm
 4  PH 1-2-3-4
 4  PZ 1-2-3-4
 4  T30 - 2xT40 - T45
 5  4-5-6-8-10 mm

- 5/16"   3/8"

Art.	
2036	5/16"



ERGOKRAFT



221 x 114 x 45 mm

Schlag-Schraubenausdreher-Satz

zum Lösen von festsitzenden, angerosteten oder defekten Schlitz- und Kreuzschlitzschrauben.



Jeu de tournevis extracteurs à frapper

pour le desserrage de vis à fente et vis cruciformes rouillées et abîmées.

Serie di giraviti estrattore con cappuccio di battuta

per svitare le viti con intaglio e viti con impronta a croce arrugginiti e danneggiati.



Art.			L mm
4149	6.0 x 100 mm	PH2 x 100 mm	195



Schraubenausdreher
Extracteur de vis
Estrattore di viti rotte

Art.	No.	<->	∅ mm	L mm
3059-1	1	M3-M6 1/8"-1/4"	2.5	52
3059-2	2	M6-M8 1/4"-5/16"	3.0	57
3059-3	3	M8-M11 5/16"-7/16"	4.0	65
3059-4	4	M11-M14 7/16"-9/16"	6.0	75
3059-5	5	M14-M18 9/16"-3/4"	8.0	80
3059-6	6	M18-M24 3/4"-1"	11.0	98



Schraubenausdreher-Satz
Jeu d'extracteurs de vis
Set estrattore di viti rotte

Art.	Nos.	<->
3059	1-2-3-4-5-6	M3-M24

6
PCS



144 x 143 x 25 mm

Bolzenausdreher
Extracteur de boulon
Estrattore per viti rotte

Art.	∅ mm	∅	L mm
3057-02	2	3/8"	60
3057-03	3	3/8"	60
3057-04	4	3/8"	60
3057-05	5	3/8"	60
3057-06	6	3/8"	60
3057-07	7	3/8"	60
3057-08	8	1/2"	78
3057-10	10	1/2"	78
3057-12	12	1/2"	78
3057-14	14	1/2"	78
3057-16	16	1/2"	78

3/8" 1/2" NiCrMo

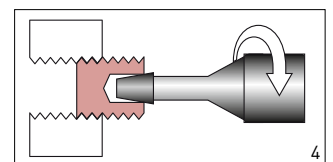
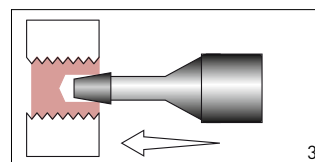
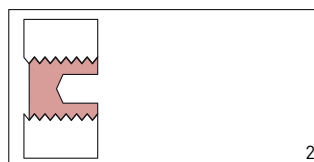
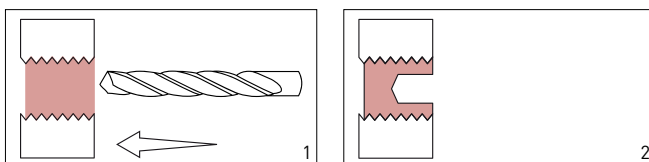

Bolzenausdreher-Satz
Jeu d'extracteurs de boulon
Set estrattori per viti rotte

3/8" 1/2" NiCrMo 11 PCS

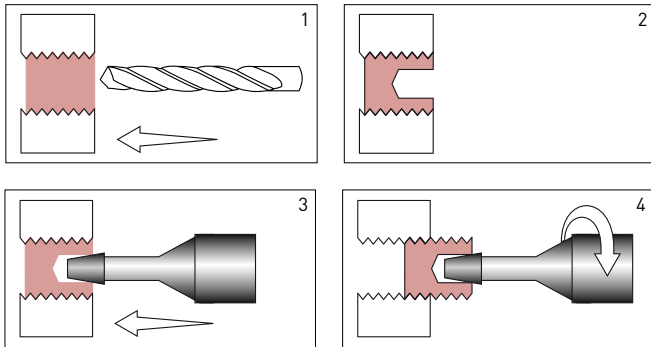

Art.	Ø mm	Ø mm
3057	2-3-4-5-6-7	8-10-12-14-16



232 x 167 x 54 mm

Bolzenausdreher
Dégougeonneuse à rouleau
Estrattore di prigionieri

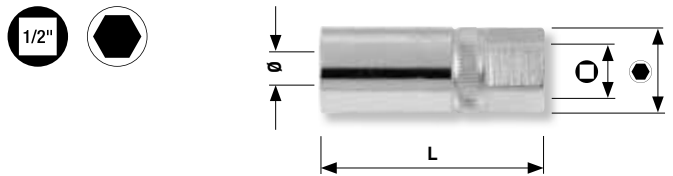

Art.	Ø	Ø	Ø	L mm
3060-06	6 mm - 1/4"	1/2"	21 mm	60
3060-08	8 mm - 5/16"	1/2"	21 mm	60
3060-10	10 mm - 3/8"	1/2"	21 mm	69
3060-12	12 mm - 7/16"	1/2"	21 mm	69

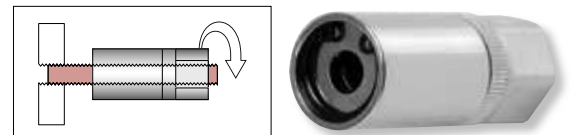

Bolzenausdreher-Satz
Jeu de dégougeonneuses à rouleau
Set estrattori di prigionieri

1/2" 4 PCS

Art.	Ø
3060	6-8-10-12 mm 1/4" - 5/16" - 3/8" - 7/16"



221 x 123 x 45 mm

Ausdreh-Stecknuss
Douille d'extraction
Estrattore per dadi rovinati

Art.	∅ mm	□
3058-10	10	1/2"
3058-11	11	1/2"
3058-12	12	1/2"
3058-13	13	1/2"
3058-14	14	1/2"
3058-15	15	1/2"
3058-16	16	1/2"
3058-17	17	1/2"
3058-19	19	1/2"

1/2" NiCrMo

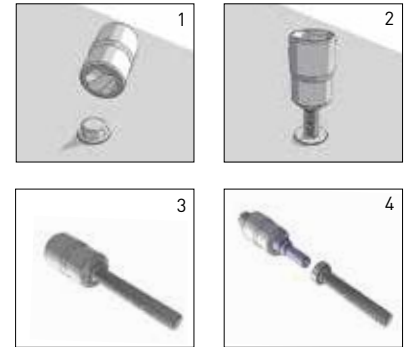

Ausdreh-Stecknuss-Satz
Jeu de douilles d'extraction
Set estrattori per dadi rovinati

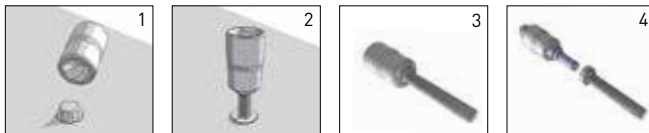

Art.	∅ mm
3058	10-11-12-13-14-15-16-17-19

1/2" NiCrMo 10
PGS



164 x 120 x 52 mm

Splinten-Abzieher
Arrache-goupille
Punta angolata per usi generici

Art.	L1 mm	L2 mm
4322-1	127	230

ERGOKRAFT



Ahle
Poinçon
Punteruolo a punta tonda

Art.	L1 mm	L2 mm
4322-2	120	225



Schlauchschellen-Abzieher
Arrache tuyau
Punta ad uncino per usi generici

Art.	L1 mm	L2 mm
4322-3	80	185

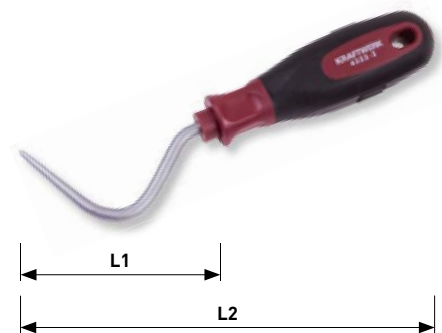

Kleiner Vollhaken
Crochet complet miniature
Punta di precisione ad uncino

Art.	L1 mm	L2 mm
4322-4	50	130

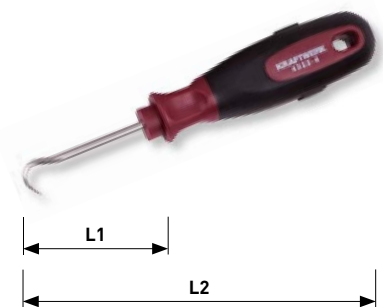

Kleiner gerader Haken
Crochet miniature droit
Punta di precisione dritta

Art.	L1 mm	L2 mm
4322-5	60	140

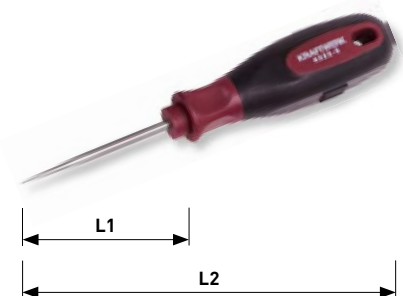

Kleiner Haken
Crochet miniature courbé
Punta di precisione piegata

Art.	L1 mm	L2 mm
4322-6	50	130

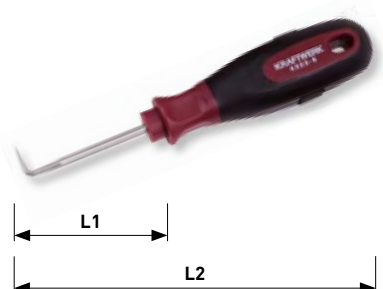

Kleiner gekröpfter Haken
Crochet miniature désaxé
Punta di precisione piegata corta

Art.	L1 mm	L2 mm
4322-7	60	140

ERGOKRAFT

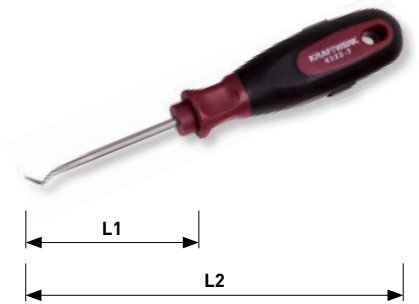

Haken- und Abzieher-Satz
Jeu de crochets et pics
Set di punteruoli e uncini



Art.
4322

7
PCS

ERGOKRAFT



Flexibler Teleskop-Magnetsucher
Doigt flexible magnétique télescopique
Penna telescopica magnetica flessibile

Art.	Ø mm	L mm
3197	11	135 - 570



1500 g



4-in-1 Magnetsucher-Satz
Jeu de doigts magnétiques 4 en 1
Set magnetico telescopico

Art.	L mm
3188	130 - 630



1500 g

4
PCS



Teleskop-Magnetsucher
Doigt magnétique télescopique
Penna telescopica magnetica

Art.	∅ mm	L mm
3196	11	130 - 630



2000 g



Biigsamer Magnetsucher
Doigt magnétique flexible
Impugnatura flessibile magnetica

Art.	∅ mm	L mm
3195	18	520



3500 g

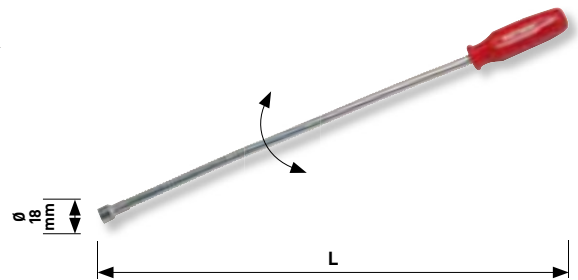

Biigsamer Krallengreifer mit Magnet
Grappin flexible à griffes avec aimant
Artiglio da presa flessibile dotato di magnete

Art.	L mm
3198	700



800 g

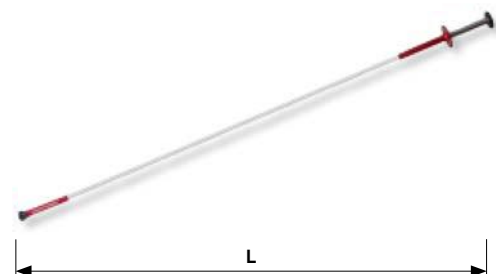

Magnetsucher-, LED- und Spiegel-Set
Jeu de doigts magnétiques, LED et miroirs
Astuccio con set magnetico telescopico, LED e specchi

Art.	L mm
3190	176 - 660

5
PCS



245 x 117 x 49 mm

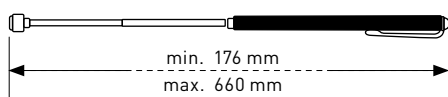





Zangenkollektion Gamme de pinces Assortimento di pinze



3C-SoftGrip



TitaniumFinish



TouchGrip

HIGHTECH 3C

Die Industrie-Zangenlinie

hergestellt aus Spezialwerkzeugstahl, gesenkgeschmiedet, ölgehärtet, mit induktiv gehärteten Präzisionsschneiden, mit blend- und reflexionsfreiem Titanium-Finish. Maximaler Halt und Ergonomie dank "Soft-Grip"-Griffen der neuesten **3-Komponenten**-Technologie, mit Aufprallschutz.

La gamme de pinces industrielles

Fabriquées à partir d'acier spécialement conçu pour les outils. Forgées, trempées à l'huile, avec des arêtes de coupe trempées par induction, une finition titane anti-éblouissement et antireflets, Adhérence et ergonomie maximale grâce aux poignées "Soft-Grip" de la dernière technologie **3-composants**, avec protection contre les chocs.

La gamma di pinze industriali

realizzate in lega di acciaio forgiato, temprato a bagno d'olio, taglienti di precisione induriti ad induzione, con finitura al titanio antireflesso. Massimo grip ed ergonomia grazie alle impugnature "soft-grip" di l'ultima tecnologia a **3 componenti**, con protezione di manici anti impatto.

ERGOKRAFT

Ergonomischer 2-Komponenten-Griff

für maximalen Griffkomfort und optimale Kraftübertragung, aus Chrom-Vanadium-Stahl, verchromt, hochglanzpoliert.

Poignées bi-matière ergonomiques

pour une plus grande puissance et un plus grand confort, en acier chrome-vanadium, chromé poli miroir.

Impugnatura Ergonomica Bi-Materiale

Progettata per assecondare le caratteristiche anatomiche della mano riducendo l'affaticamento e aumentando la trasmissione della forza. Realizzata in acciaio cromo vanadio è dotata di impugnatura bi-materiale micro puntinata per il massimo grip.



Kombinationszange
Pince universelle
Pinza universale

Art.	K Ø mm	C Ø mm	H Ø mm	L mm
4271-165	10	4.0	2.0	165
4271-180	12	5.2	2.2	180
4271-205	13	5.9	2.5	205

Ergonomische Kraft-Kombinationszange 45°

- 45° abgewinkelt für muskel- und sehnenschonendes Arbeiten dank gerader Haltung der Hand beim Greifen, Drehen und Ziehen.
- Höheres Drehmoment durch Hebelwirkung des Winkels.

Pince combinée ergonomique 45° - haute performance

- Coudée à 45°, un angle de tenue approprié par une position ergonomique de la main dans le prolongement du poignet, pour agripper, tourner et tirer.
- Force de torsion plus élevée grâce à l'effet levier.

Pinza universale ergonomica 45° a grande effetto

- La testa inclinata di 45° permette di lavorare con la mano in posizione naturale e corretta.
- Maggior grip e trasmissione della forza.

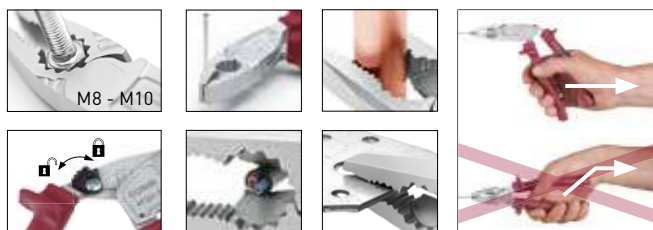

Art.	K Ø mm	C Ø mm	H Ø mm	L mm
4201-200P	13	2.5	5.9	200

Kombinationszange
Pince universelle
Pinza universale

Art.	L mm
3281-160	160
3281-180	180
3281-200	200

HIGHTECH 3C

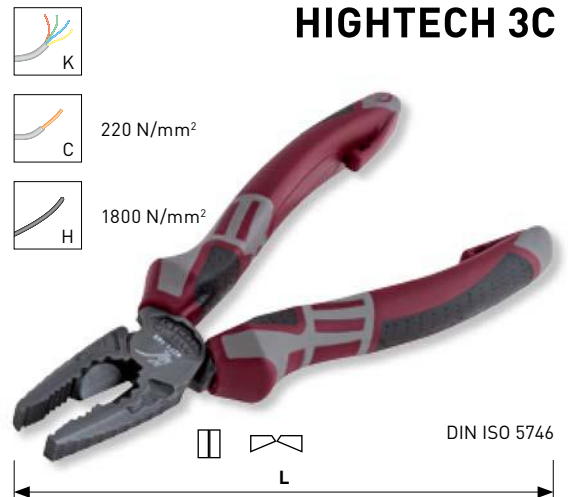

HIGHTECH



ERGOKRAFT

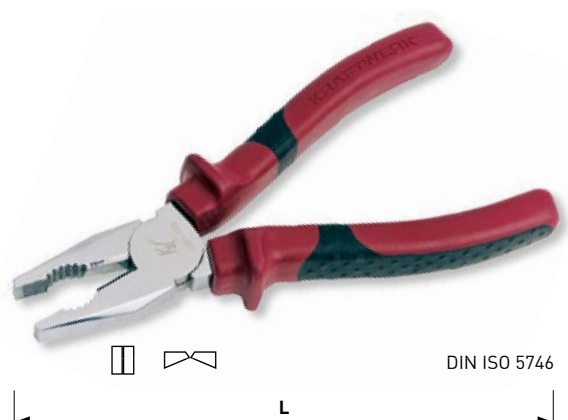

Seitenschneider
Pince coupante diagonale
Tronchese a taglianti diagonali

Art.	K Ø mm	C Ø mm	H Ø mm	L mm
4272-145	8	5	1.7	145
4272-160	11	6	2.0	160
4272-180	13	7	2.5	180



220 N/mm²

1800 N/mm²

HIGHTECH 3C



Elektriker-Seitenschneider
Pince coupante diagonale, modèle électricien
Tronchese a taglianti diagonali per elettricisti

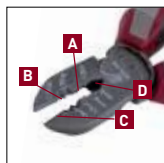

- A** Pressen
Sertir
Comprimere
- B** Abisolieren
Dénuder
Spellare fili
1.5-2.5 mm²
- C** Schneiden
Couper
Tagliare
- D** Biegen
Courber
Piegare

Art.	K Ø mm	C Ø mm	H Ø mm	L mm
4272-190	4	2	1	190



220 N/mm²

1800 N/mm²

HIGHTECH 3C



Seitenschneider
Pince coupante diagonale
Tronchese a taglianti diagonali

Art.	L mm
3282-140	140
3282-160	160

ERGOKRAFT



Kraft-Seitenschneider

Pince coupante diagonale - haute performance
Tronchesi a grande effetto a taglienti diagonali

Art.	M Ø mm	H Ø mm	P Ø mm	L mm
4273-180	3.7	2.6	2.2	180
4273-200	4.0	2.8	2.5	200

Hebel-Kraft-Seitenschneider

Extrem leichtes Schneiden mit geringem Kraftaufwand dank optimaler Übersetzung durch Doppelgelenk-Konstruktion.

Pincès coupantes diagonales à levier - haute performance

Une coupe extrêmement aisée nécessitant peu d'effort, grâce à son système de démultiplication et à la conception de son mécanisme à double articulation.

Tronchese anti-sforzo a taglio diagonali

Taglio estremamente facilitato con minimo sforzo grazie alla rapporto di trasmissione con la struttura della doppia articolazione.



Art.	M Ø mm	H Ø mm	P Ø mm	L mm
4274-200	4.5	3.5	3.0	200

Kraft-Seitenschneider

Pince coupante diagonale - haute performance
Tronchesi anti-sforzo a taglienti diagonali

Art.	L mm
3283-180	180

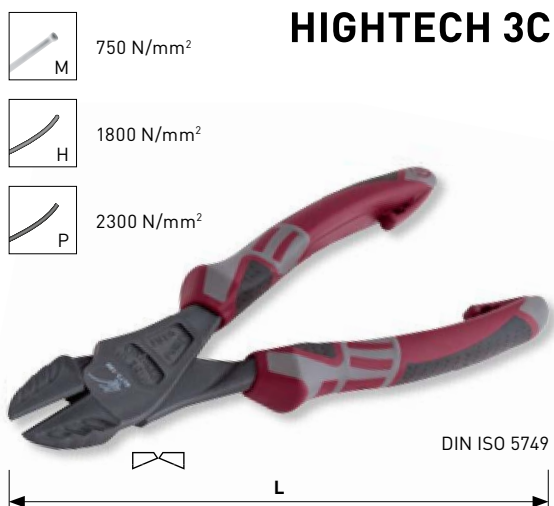

Hebel-Kraft-Vornschnaider

Extrem leichtes Schneiden mit geringem Kraftaufwand dank optimaler Übersetzung durch Doppelgelenk-Konstruktion.

Pince coupante devant à levier - haute performance

Une coupe extrêmement aisée nécessitant peu d'effort, grâce à son système de démultiplication et à la conception de son mécanisme à double articulation.

Tenaglia "HIGH POWER"

Taglio estremamente facilitato con minimo sforzo grazie alla rapporto di trasmissione con la struttura della doppia articolazione.



Art.	C Ø mm	M Ø mm	H Ø mm	L mm
4214-200	4.5	4.0	3.5	200



750 N/mm²



1800 N/mm²



2300 N/mm²



HIGHTECH

Kraft-Vornschnaider

Pince coupante devant

Tenaglia a taglienti frontale

Art.	L mm
3284-160	160

ERGOKRAFT



DIN ISO 5748

Flachrundzange (Telefonzange)

Pince à bec demi-rond

Pinze a becchi mezzotondi lunghi diritti

Art.	C Ø mm	H Ø mm	L mm
4275-170	2.5	1.6	170
4275-205	3.9	2.2	205

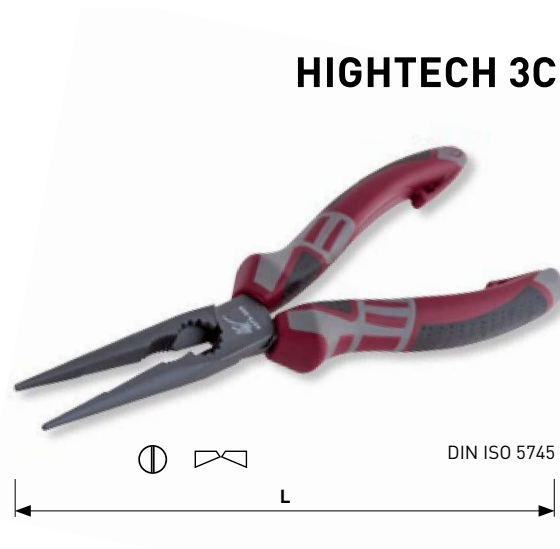

Ergonomische multifunktionale Flachrundzange 45°

- 45° abgewinkelt für muskel- und sehnenschonendes Arbeiten dank gerader Haltung der Hand beim Greifen, Drehen und Ziehen.
- Höheres Drehmoment durch Hebelwirkung des Winkels.

Pince à bec demi-rond multifonction 45°

- *Coudée à 45 °, un angle de tenue approprié par une position ergonomique de la main dans le prolongement du poignet, pour agripper, tourner et tirer.*
- *Force de torsion plus élevée grâce à l'effet levier.*

Pinza a becchi semitondi multifunzione 45°

- La testa inclinata di 45° permette di lavorare con la mano in posizione naturale e corretta.
- Maggior grip e trasmissione della forza.

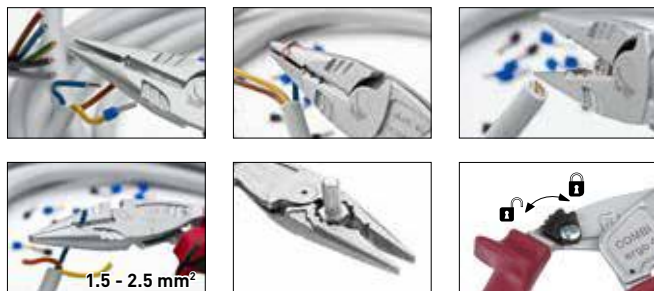

Art.	K mm ²	K Ø mm	C Ø mm	H Ø mm	L mm
4205-200P	1.5-2.5	13	5.9	2.5	200

HIGHTECH



220 N/mm²

1800 N/mm²

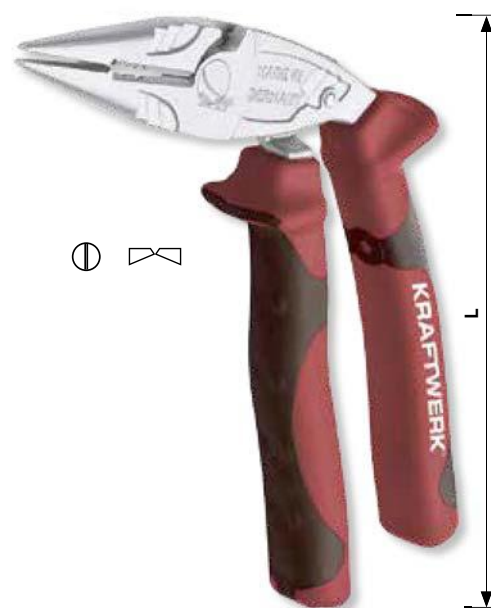

Flachrundzange (Telefonzange)

Pince à bec demi-rond

Pinze a becchi mezzotondi lunghi diritti

Art.	L mm
3285-160	160
3285-200	200

Flachrundzange (Telefonzange), 45° abgewinkelt

Pince à bec demi-rond, coudé 45°

Pinza a becchi mezzotondi lunghi diritti,
piegati a 45°

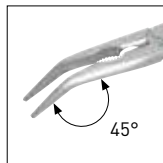

Art.	C Ø mm	H Ø mm	L mm
4276-205	3.9	2.2	205

**Flachrundzange (Telefonzange),
45° abgewinkelt**

Pince à bec demi-rond, coudé 45°

Pinza a becchi mezzotondi lunghi diritti,
piegati a 45°

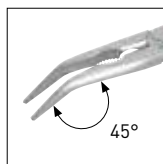

Art.	L mm
3286-200	200

ERGOKRAFT

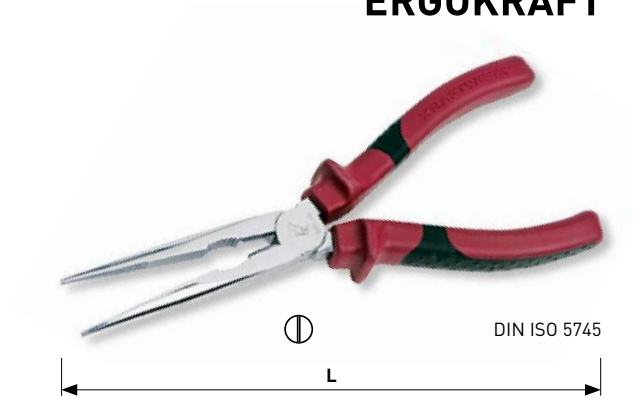

HIGHTECH 3C



220 N/mm²



1800 N/mm²



ERGOKRAFT

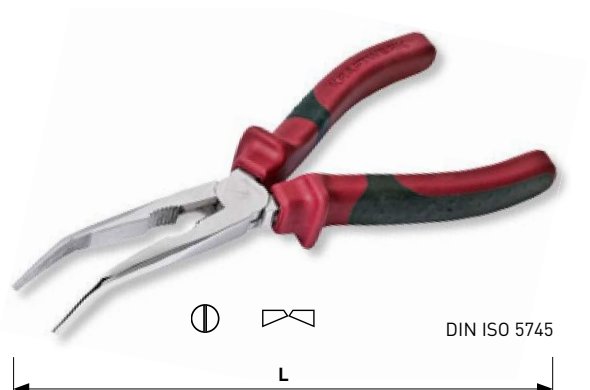

Doppel-X-Spezial-Zangen-Satz

mit 2 extra langen Flachrundzangen, gerade und 45° gekröpft.
Doppel-X-System für optimale Kraftübertragung bis in die Spitzen.

Jeu de pinces spéciales double X

avec 2 pinces extra longues spéciales double X, droite et
coupée à 45°. Le système en double X permet un transfert de
force optimal jusqu'aux extrémités de la pince.

Set pinze speciali a doppio X

con 2 pinze speciali a doppio X extralunghe a becchi mezzotondi
lungi diritti e piegati a 45°. Sistema a doppia X per una
distribuzione ottimale della forza.



Art.	L mm
30001	330



Langbeck-Flachzange

Pince à bec plat

Pinza a becchi piatti lunghi diritti

Art.	L mm
4277-160	160

HIGHTECH 3C



Langbeck-Flachzange

Pince à bec plat

Pinza a becchi piatti lunghi diritti

Art.	L mm
3287-160	160

ERGOKRAFT



Langbeck-Rundzange

Pince à bec rond

Pinza a becchi tondi lunghi diritti

Art.	L mm
4278-160	160

HIGHTECH 3C

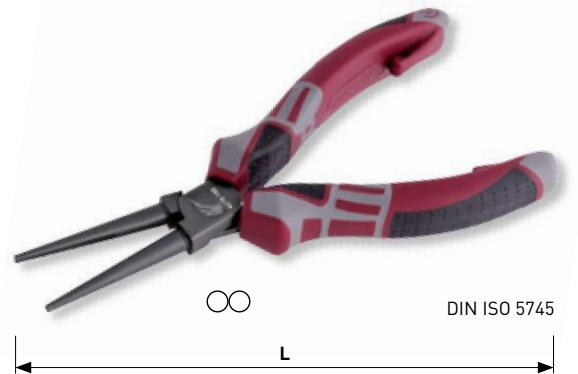

Langbeck-Rundzange

Pince à bec rond

Pinza a becchi tondi lunghi diritti

Art.	L mm
3288-160	160

ERGOKRAFT



Abisolierzange

Pince à dénuder

Pinza spellafili

Art.	K mm ²	K Ø mm	L mm
4279-160	0.5 - 10	5	160

HIGHTECH 3C



Multifunktions-Abisolierzange
Pince à dénuder multifonction
Pinza spellafili multifunzione



Art.	K mm ²	K Ø mm	C Ø mm	H Ø mm	L mm
4279-180	5 - 16	11	6	2	180



220 N/mm²



1800 N/mm²

HIGHTECH 3C



DIN ISO 5745

Abisolierzange
Pince à dénuder
Pinza spellafili

Art.	K mm ²	K Ø	L mm
3289-160	0.5 - 10	5	160

ERGOKRAFT

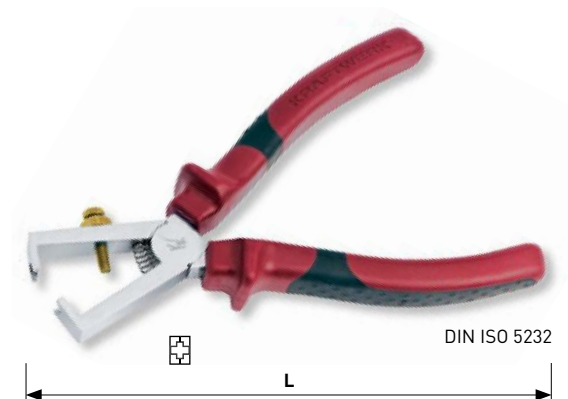

DIN ISO 5232

Zangen-Satz
Jeu de pinces
Set di pinze



DIN ISO 5746

180 mm

Art. 3281-180



DIN ISO 5749

160 mm

Art. 3282-160



DIN ISO 5745

200 mm

Art. 3285-200



DIN ISO 8976

250 mm

Art. 2221-250

Art.
3292

4
PCS

ERGOKRAFT



Sicherheits-Kombinationszange 1000 V

Pince universelle, isolée 1000 V

Pinza universale, isolata 1000 V

Art.	K Ø mm	C Ø mm	H Ø mm	L mm
4211-180	12	5.2	2.2	180



HIGHTECH



220 N/mm²



1800 N/mm²

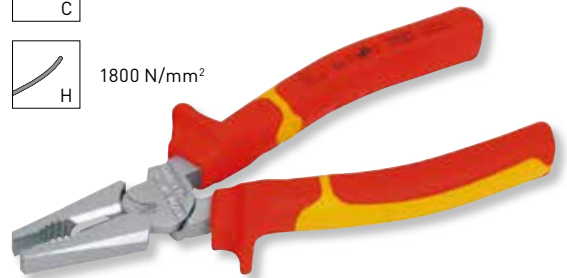

DIN ISO 5746

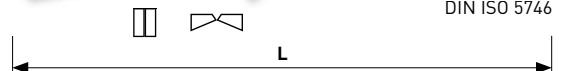

Sicherheits-Kombinationszange 1000 V

Pince universelle, isolée 1000 V

Pinza universale, isolata 1000 V

Art.	L mm
3281-180V	180



ERGOKRAFT



DIN ISO 5746

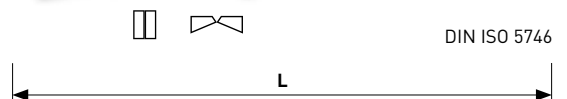

Sicherheits-Seitenschneider 1000 V

Pince coupante diagonale, isolée 1000 V

Tronchese a tagliente diagonale, isolato 1000 V

Art.	K Ø mm	C Ø mm	H Ø mm	L mm
4212-160	11	6.0	2.0	160
4212-180	13	7.0	2.5	180



HIGHTECH



220 N/mm²



1800 N/mm²



DIN ISO 5749

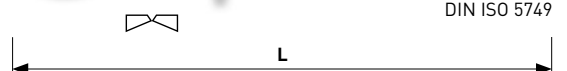

Sicherheits-Seitenschneider 1000 V
Pince coupante diagonale, isolée 1000 V
 Tronchese a tagliente diagonale, isolato 1000 V



ERGOKRAFT



DIN ISO 5749

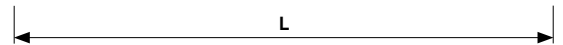

Art.	L mm
3282-160V	160

Sicherheits-Kraft-Seitenschneider 1000 V
*Pince coupante diagonale -
 haute performance, isolée 1000 V*
 Tronchesi a grande effetto a tagliente diagonale,
 isolato 1000 V



HIGHTECH



1800 N/mm²



2300 N/mm²



DIN ISO 5749

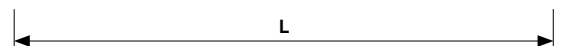

Art.	H Ø mm	P Ø mm	L mm
4213-180	2.6	2.2	180
4213-200	2.8	2.5	200

Sicherheits-Flachrundzange (Telefonzange) 1000 V
Pince à bec demi-rond, isolée 1000 V
 Pinza a becchi mezzotondi lunghi diritti,
 isolata 1000 V



HIGHTECH



220 N/mm²



1800 N/mm²



DIN ISO 5745

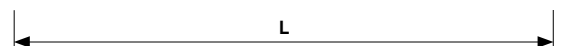

Art.	C Ø mm	H Ø mm	L mm
4215-205	3.9	2.2	205

Sicherheits-Flachrundzange (Telefonzange) 1000 V
Pince à bec demi-rond, isolée 1000 V
Pinza a becchi mezzotondi lunghi diritti, isolata 1000 V



ERGOKRAFT

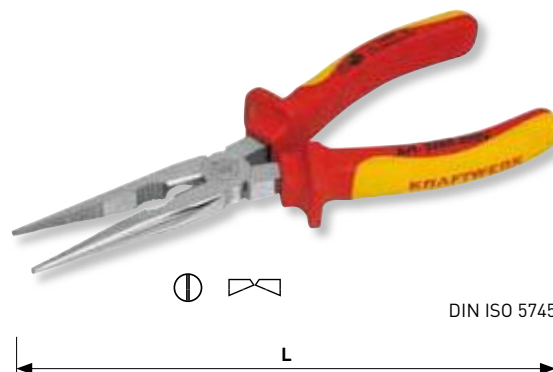

Art.	L mm
3285-200V	200

Sicherheits-Flachrundzange (Telefonzange) 1000 V, 45° abgewinkelt
Pince à bec demi-rond coudé 45°, isolée 1000 V
Pinza a becchi mezzotondi lunghi diritti, piegati a 45°, isolata 1000 V



HIGHTECH

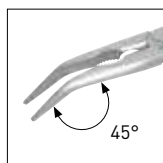
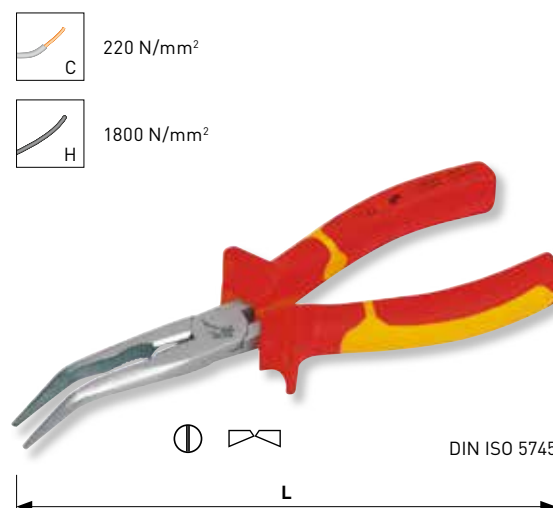

Art.	C Ø mm	H Ø mm	L mm
4216-205	3.9	2.2	205

Sicherheits-Abisolierzange 1000 V
Pince à dénuder, isolée 1000 V
Pinza spellafili, isolata 1000 V



HIGHTECH

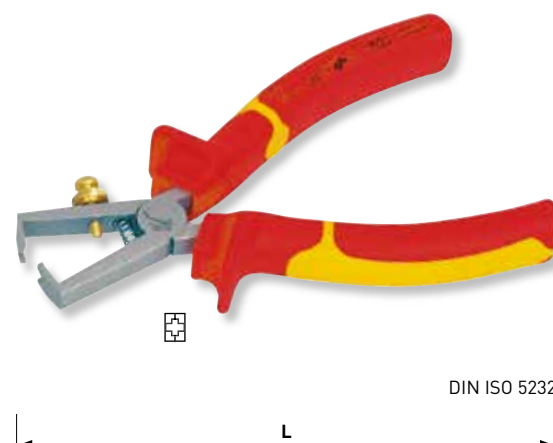

Art.	K mm ²	K Ø mm	L mm
4219-160	0.5 - 10	5	160

Sicherheits-Abisolierzange 1000 V
Pince à dénuder, isolée 1000 V
 Pinza spellafili, isolata 1000 V



ERGOKRAFT

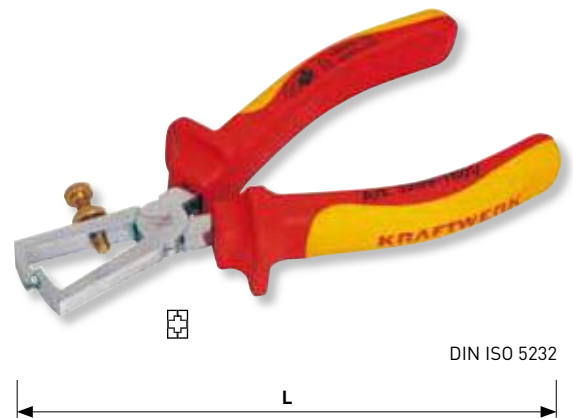

DIN ISO 5232

Art.	K mm ²	K Ø mm	L mm
3289-160V	0.5 - 10	5	160

Sicherheits-Kabelschneider 1000 V
Pince coupe-fils, isolée 1000 V
 Tagliacavi, isolati 1000 V



HIGHTECH



Art.	K mm ² Al + Cu	K Ø Al + Cu	L Ø mm
4210-160	50	16	160
4210-210	70	25	210

Sicherheits-Wasserpumpenzange 1000 V
Pince multiprise, isolée 1000 V
 Pinza regolabile, isolata 1000 V



HIGHTECH

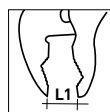

DIN ISO 8976

Art.	L1 mm	L2 mm
4220-250	50	250

Elektronik-Kombinationszange
Pince universelle électronique
Pinza universale per elettronica

Art.	L mm
2236	110



Elektronik-Seitenschneider
Pince coupante diagonale électronique
Tronchese per elettronica a tagliente diagonale

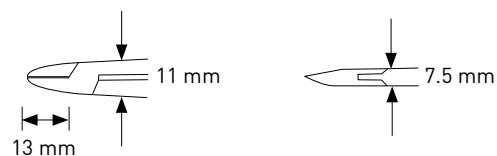

Art.	C Ø mm	H Ø mm	P Ø mm	L mm
4235-115	1.2	0.6	0.4	115



220 N/mm²

1800 N/mm²

2300 N/mm²

HIGHTECH



Elektronik-Seitenschneider, bündig
Pince coupante diagonale électronique, coupe à ras
Tronchese per elettronica a tagliente raso diagonale

Art.	L mm
2234	110



Elektronik-Seitenschneider, halbbündig

Pince coupante diagonale électronique, coupe semi-ras

Tronchese per elettronica a tagliente semiraso diagonale

Art.	L mm
2235	105

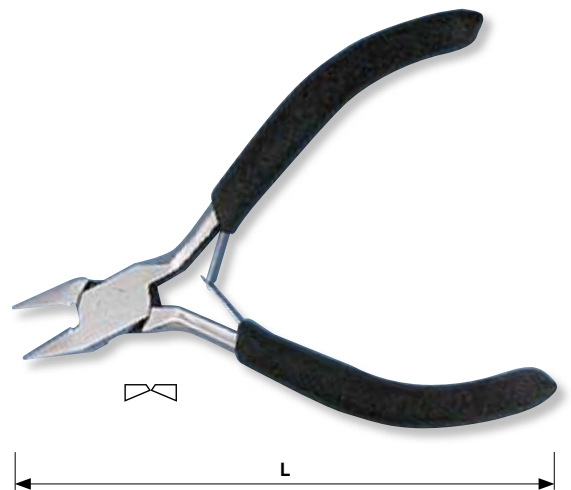

Elektronik-Vornschneider

Pince coupante devant électronique

Tronchese per elettronica a tagliente frontale

Art.	L mm
2237	100



Elektronik-Flachrundzange, glatt

Pince électronique à bec demi-rond lisse

Pinza per elettronica a becchi mezzotondi lisci

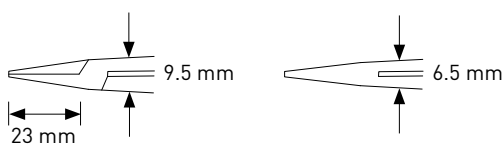

Art.	L mm
4233-115	115



HIGHTECH



Elektronik-Spitzzange

Pince électronique à bec demi-rond

Pinza per elettronica a becchi mezzotondi lunghi

Art.	L mm
2231	120



Elektronik-Langspitzzange

Pince électronique à bec demi-rond long

Pinza per elettronica a becchi mezzotondi extra-lunghi

Art.	L mm
2232	150

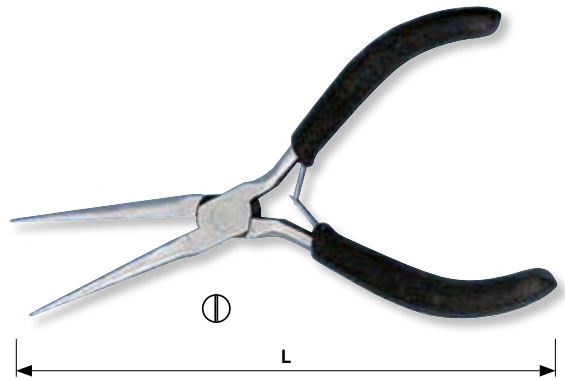

Elektronik-Kettenzange, 45° abgewinkelt, glatt

Pince électronique à bec demi-rond lisse coudé 45°

Pinza per elettronica a becchi mezzotondi lisci, piegati 45°

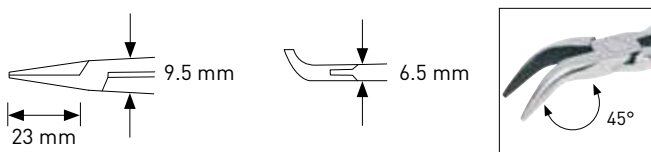

Art.	L mm
4234-115	115



HIGHTECH



Elektronik-Spitzzange, 45° abgewinkelt
Pince électronique à bec demi-rond coudé 45°
Pinza per elettronica a becchi mezzotondi, piegati 45°

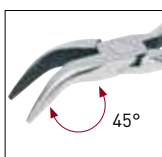

Art.	L mm
2238	115

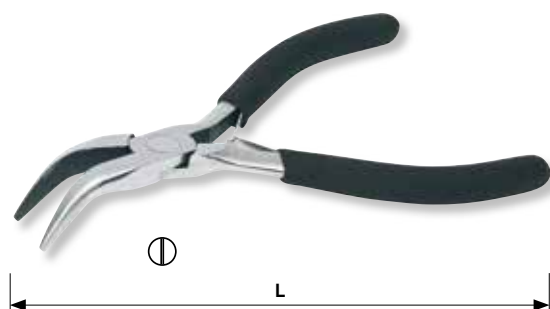

Elektronik-Flachzange, glatt
Pince électronique à bec plat lisse
Pinza per elettronica a becchi piatti lisci

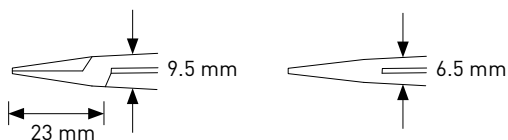

Art.	L mm
4231-115	115



HIGHTECH



Elektronik-Flachzange
Pince électronique à bec plat
Pinza per elettronica a becchi piatti

Art.	L mm
2233	120

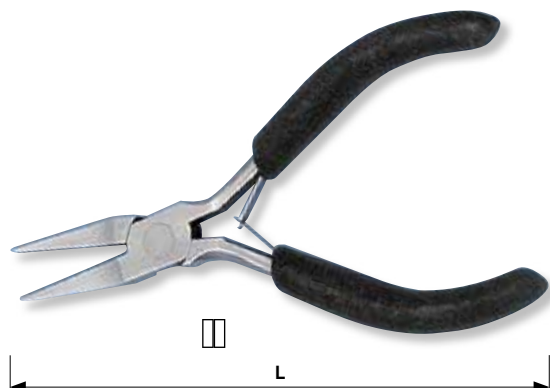

Elektronik-Rundzange

Pince électronique à bec rond

Pinza per elettronica a becchi tondi

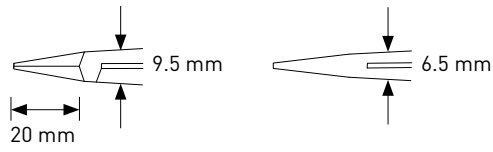

Art.	L mm
4232-115	115



HIGHTECH



Kneifzange

Tenaille

Tenaglia

Art.	L mm
4242-180	180
4242-210	210
4242-250	250

HIGHTECH



Kneifzange

Tenaille

Tenaglia

Art.	L mm
2216-180	180
2216-200	200



Kraft-Rabitzzange

Tenaille russe - haute performance

Tenaglie per cementisti a grande effetto

Art.	C Ø mm	M Ø mm	H Ø mm	L mm
4241-230	4.2	3.4	2.4	230
4241-260	4.2	3.8	2.6	260
4241-300	4.2	4.0	2.8	300

Rabitzzange

Tenaille russe

Tenaglia per cementisti

Art.	L mm
2217-250	250
2217-280	280

Wasserpumpenzange

mit invertiert durchgestecktem Sicherheitsgelenk

Pince multiprise

à charnière entrecroisée de sécurité

Pinza regolabile

a cerniera passante di sicurezza

Art.	L1 mm	L2 mm
4223-180	40	180
4223-240	50	240
4223-300	65	300
4223-400	100	400



 45% POWER

HIGHTECH



220 N/mm²



750 N/mm²



1800 N/mm²

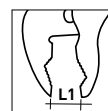

HIGHTECH



Wasserpumpenzange

mit invertiert durchgestecktem Sicherheitsgelenk und Druckknopf-Verstellung

Pince multiprise

à charnière entrepassée avec verrouillage rapide par bouton-poussoir pour le réglage direct

Pinza regolabile

a cerniera passante invertita di sicurezza e pulsante per la regolazione diretta

Art.	L1 mm	L2 mm
4222-180	35	180
4222-250	50	250
4222-300	65	300

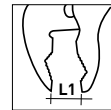

HIGHTECH



DIN ISO 8976

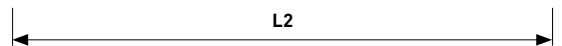

4Grip-Wasserpumpenzange

mit invertiert durchgestecktem Sicherheitsgelenk, Druckknopf-Verstellung und automatischer Maulweitenanpassung = Knopf drücken, Zange öffnen, Knopf loslassen und passgenau an das Werkstück schieben! Maul mit doppelt verzahnter Rautenform für alle Werkstücke und Nagel-/Drahthalter. Klemmschutz in jeder Position. Kompakt, schmal, robust.

Pince multiprise 4Grip

à charnière entrepassée avec verrouillage rapide par bouton-poussoir pour le réglage direct et l'ajustement automatique des mâchoires = pressez le bouton, ouvrez la pince et poussez le bec supérieur contre la pièce ! Mâchoires à double dentition en forme de losange pour toutes les pièces et supports, clous et fils. Protection de serrage dans chaque position. Compacte, effilée, robuste.

Pinza regolabile 4Grip

a cerniera passante di sicurezza. Pulsante per la regolazione automatica della larghezza della bocca e adattamento automatico al pezzo da afferrare grazie all'innovativa regolazione del passo (QuattroGripp). Ganasce a doppia dentellatura per una presa sicura su qualsiasi oggetto, dotata di presa per chiodi e fili. Fermo di sicurezza in ogni posizione. Compatta, sottile e robusta.

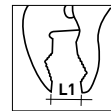

DIN ISO + 40%



4GRIP

HIGHTECH



DIN ISO 8976

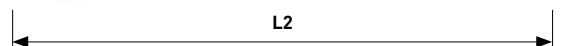

Art.	L1 mm	L2 mm
4224-250	50	250
4224-320	75	320
4224-400	100	400
4224	Satz / Jeu / Assortimento 4224-250 + 4224-320	250 + 320



40% > DIN ISO

drag & drop

2
PCS



Wasserpumpenzange

mit durchgestecktem Gelenk und Soft-Grip-Handgriffen

Pince multiprise

à charnière entrecroisée et poignées soft-grip

Pinza regolabile

a cerniera passante e impugnatura morbida

Art.	L1 mm	L2 mm
3290-175	25	180
3290-250	32	250
3290-300	42	300
99067	Satz / Jeu / Assortimento	180 + 250 + 300

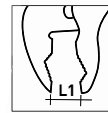

ERGOKRAFT



DIN ISO 8976

3
PCS

Automatik-Wasserpumpenzange

mit praktischer Einhand-Automatikverstellung, optimal für enge Stellen. Isolierte Soft-Grip-Handgriffe.

Pinces réglables automatiques

réglables d'une seule main, idéales pour les endroits difficilement accessibles. Manches Soft-Grip isolés.

Pinze regolabili automatiche

con regolazione automatica con una mano sola, ottimo utilizzo in spazi stretti. Impugnatura isolata Soft-Grip.

Art.	L1 mm	L2 mm	L2 inch
3266-180	32	180	7"
3266-250	40	250	10"
3266-300	50	300	12"
3266SET	32+40+50	180+250+300	7"+10"+12"

CrV



3
PCS

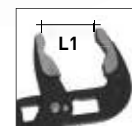

Zangenschlüssel

mit invertiert durchgestecktem Sicherheitsgelenk, Druckknopf-Verstellung und parallel greifenden, beweglichen Backen.

Pince-clé

à charnière entrecroisée avec verrouillage rapide par bouton-poussoir pour le réglage direct. Mâchoires de prise parallèle et mobile.

Pinza chiave

per montaggio rubinetti e miscelatori a cerniera passante invertita di sicurezza, pulsante per la regolazione diretta e ganasce parallele e mobili.

Art.	L1 mm / "	L2 mm
4225-250	0-53 / 0-2	250

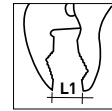

HIGHTECH

DIN ISO 8976

Schwedisch-Eckrohrzange

Kopf 45°, Backen S-Form

Clé serre-tube suédoise

tête 45°, mors en S

Giratubo modello svedese

testa 45°, ganascia form di S

Art.	L1 inch	L2 mm
5406-320	1"	320
5406-420	1-1/2"	420
5406-540	2"	540

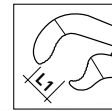

Stillson-Rohrzange

Clé serre-tube type Stillson

Giratubo modello Stillson

Art.	L mm / inch
5405-250	250 / 10"
5405-350	350 / 14"
5405-450	450 / 18"
5405-600	600 / 24"
5405-900	900 / 36"



Eckrohrzange mit verstellbarem Kopf

Typ „Stillson“, mit Aluminium Gusskörper und 180° schwenkbarem Aluminium-Griff, Backen aus Chrom-Molybdän Stahl, stufenlos verstellbar über Rändelmutter, maximale Zangenöffnung 2" / 52 mm.

Clé serre-tube à tête ajustable

Type "Stillson", corps en fonte d'aluminium et poignée alu articulée à 180°, mâchoire en acier chrome-molybdène. Réglage en continu par une molette, ouverture maximale 2" / 52 mm.

Giratubo con testa regolabile

tipo "Stillson", in lega di alluminio ed impugnatura in alluminio snodabile a 180°, ganasce in cromo-molibdèno, impostazione variabile tramite dado zigrinato, massima apertura 2" / 52 mm.

Art.
5405-290

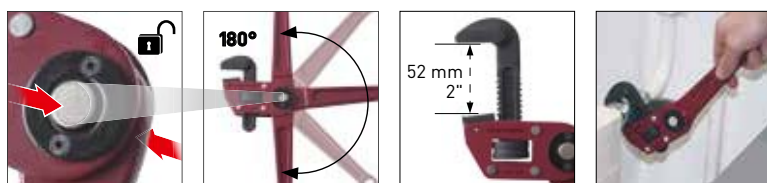

Stufenschlüssel-Satz

5-stufig, mit Umsteckknarre und Stecknuss-Adapter 1/2".

Jeu de clé de montage étagée

avec 5 étages, cliquet traversant et adaptateur pour douilles 1/2".

Set di chiavi per radiatori universali

5 dimensioni, con cricchetto passante ed adattatore per chiavi a bussola 1/2".

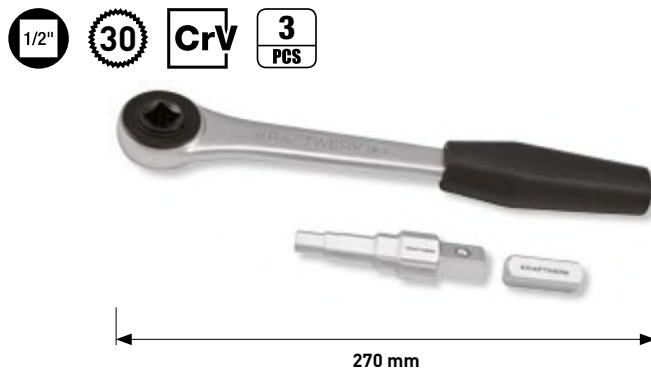

Art.	
5461SET	<ul style="list-style-type: none"> 10 mm 3/8" 11 mm 7/16" 12.5 mm 1/2" 16 mm 5/8" 21 mm 13/16"

Sicherungsringzange

für Aussenringe, öffnende gerade Spitzen, mit Feder

Pince pour circlips

extérieurs, à pointes ouvrantes droites, avec ressort

Pinza Seeger

a becchi diritti per anelli esterni, con molla

Art.	Typ / mm	Ø mm	L mm
4252-A0	A0 / 3-10	0.9	135
4252-A1	A1 / 10-25	1.3	135
4252-A2	A2 / 19-60	1.8	175
4252-A3	A3 / 40-100	2.3	220
4252-A4	A4 / 85-165	3.2	310

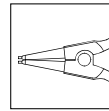

HIGHTECH

Sicherungsringzange

für Aussenringe, öffnende gerade Spitzen, mit Feder

Pince pour circlips

extérieurs, à pointes ouvrantes droites, avec ressort

Pinza Seeger

a becchi diritti per anelli esterni, con molla

Art.	Typ / mm	Ø mm	L mm
2212-A2	A2 / 19-60	1.8	180

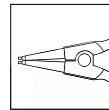

Sicherungsringzange

für Aussenringe, öffnende 90° abgewinkelte Spitzen, mit Feder

Pince pour circlips

extérieurs, à pointes ouvrantes à 90°, avec ressort

Pinza Seeger

a becchi piegati a 90° per anelli esterni, con molla

Art.	Typ / mm	Ø mm	L mm
4253-A01	A01 / 3-10	0.9	125
4253-A11	A11 / 10-25	1.3	125
4253-A21	A21 / 19-60	1.8	165
4253-A31	A31 / 40-100	2.3	200
4253-A41	A41 / 85-165	3.2	290

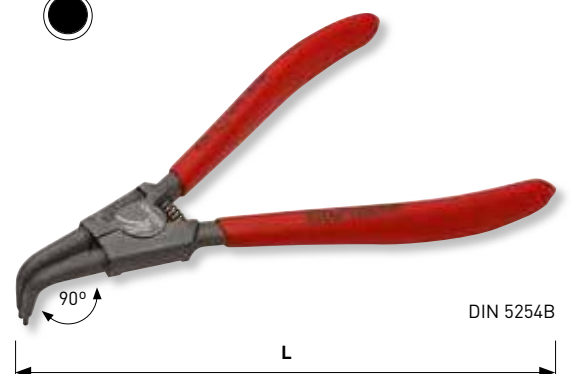
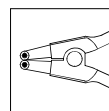

HIGHTECH

Sicherungsringzange

für Aussenringe, öffnende 90° abgewinkelte Spitzen, mit Feder

Pince pour circlips

extérieurs, à pointes ouvrantes à 90°, avec ressort

Pinza Seeger

a becchi piegati a 90° per anelli esterni, con molla

Art.	Typ / mm	Ø mm	L mm
2213-A21	A21 / 19-60	1.8	165

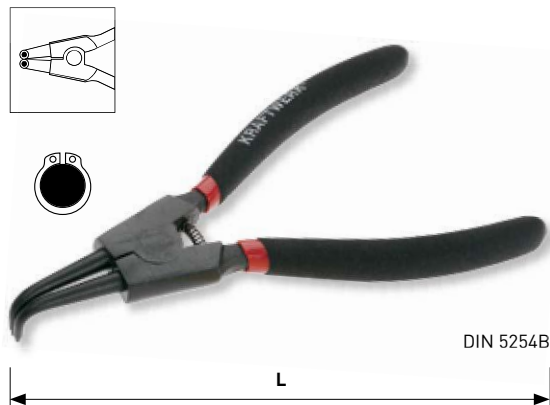

Sicherungsringzange

für Innenringe, schliessende gerade Spitzen

Pince pour circlips

intérieurs, à pointes fermantes droites

Pinza Seeger

a becchi diritti per anelli interni

Art.	Typ / mm	Ø mm	L mm
4254-J0	J0 / 8-13	0.9	135
4254-J1	J1 / 12-25	1.3	135
4254-J2	J2 / 19-60	1.8	175
4254-J3	J3 / 40-100	2.3	220
4254-J4	J4 / 85-165	3.2	310

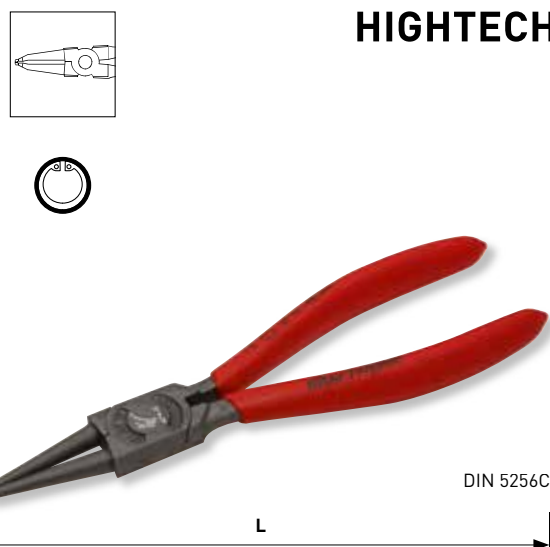

Sicherungsringzange

für Innenringe, schliessende gerade Spitzen

Pince pour circlips

intérieurs, à pointes fermantes droites

Pinza Seeger

a becchi diritti per anelli interni

Art.	Typ / mm	Ø mm	L mm
2214-J2	J2 / 19-60	1.8	180

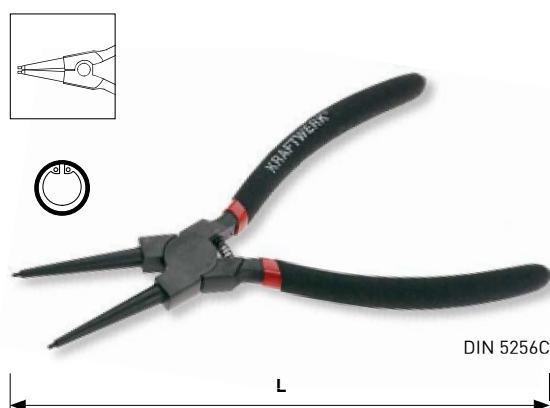

Sicherungsringzange

für Innenringe, schliessende 90° abgewinkelte Spitzen

Pince pour circlips

intérieurs, à pointes fermantes à 90°

Pinza Seeger

a becchi piegati a 90° per anelli interni

Art.	Typ / mm	Ø mm	L mm
4255-J01	J01 / 8-13	0.9	125
4255-J11	J11 / 12-25	1.3	125
4255-J21	J21 / 19-60	1.8	165
4255-J31	J31 / 40-100	2.3	200
4255-J41	J41 / 85-165	3.2	290

Sicherungsringzange

für Innenringe, schliessende 90° abgewinkelte Spitzen

Pince pour circlips

intérieurs, à pointes fermantes à 90°

Pinza Seeger

a becchi piegati a 90° per anelli interni

Art.	Typ / mm	Ø mm	L mm
2215-J21	J21 / 19-60	1.8	165

Sicherungsringzangen-Satz

Jeu de pinces pour circlips

Set assortito di pinze per anelli elastici di sicurezza

Art.	bestehend aus / composé de / composto da
4286	4252-A2, 4253-A21, 4254-J2, 4255-J21

Sicherungsringzangen-Satz

Jeu de pinces pour circlips

Set assortito di pinze Seeger

Art.	bestehend aus / composé de / composto da
2212	2212-A2, 2213-A21, 2214-J2, 2215-J21

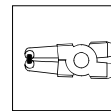

HIGHTECH

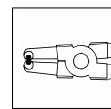

4
PCS

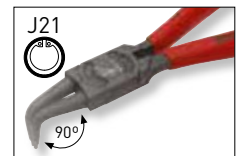
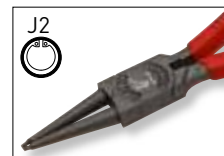
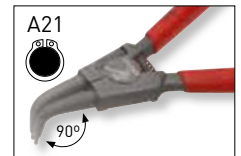

HIGHTECH

4
PCS

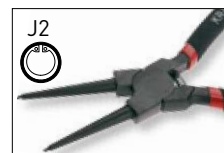

4-in-1 Kombi-Sicherungsringzange

für Aussen- und Innensicherungen von 10-50 mm mit 4 Spitzenköpfen für 180°, 90°, 45°. Backenwechsel in Sekunden für verschiedene Anwendungen.

Pince combinée 4-en-1 pour circlips

pour circlips extérieurs et intérieurs de 10 à 50 mm avec 4 têtes interchangeable pour 180°, 90°, 45°. Changement rapide des têtes pour 6 usages différents.

Pinza combinata 4-in-1 Seeger

per anelli esterni ed interni da 10 a 50 mm, con 4 teste a punta per 180°, 90°, 45°. Sostituzione delle teste in pochi secondi per 6 applicazioni differenti.

Art.	Typ / mm	Ø mm	L mm
2211	A1-A2, J1-J2 / 10-50 mm	1.35	155

4
PCS



Schlauchklemmenzange

Pince à raccord durites

Pinza per anelli stringitubo

Art.	L mm
4251-175	175



HIGHTECH



Auswuchtgewichtzange

Pince pour masses d'équilibrage des roues

Pinza combinata per equilibratura ruote

Art.	L mm
4256-240	240



AUTOMOTIVE



Gripzange mit Rundbacken
Pince-étau à mâchoires rondes
Pinza a morsetto a becchi rotondi

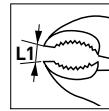

CrMo



Art.	L1 mm	L2 mm / inch
3292-175	43	max. 175 / 7"
3292-250	58	max. 250 / 10"

Langbeck-Gripzange
Pince-étau à bec long
Pinza regolabile autobloccante a becchi lunghi

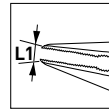

CrMo

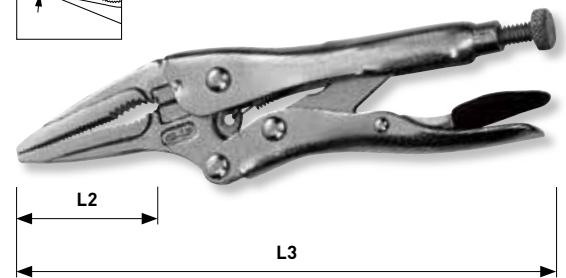

Art.	L1 mm	L2 mm	L3 mm / inch
3292-150	50	45	max. 150 / 6"

Schweisser-Gripzange
Pince-étau pour cornières
Pinza regolabile autobloccante con ganasce a forcella

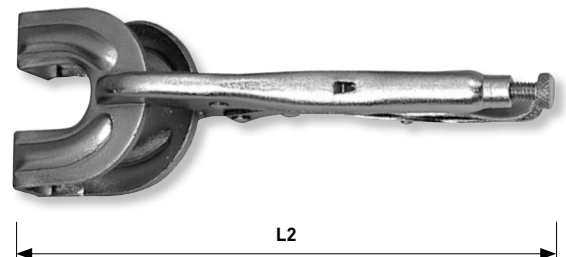
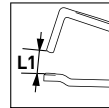

Art.	L1 mm	L2 mm / inch
2252-225	41	max. 225 / 9"

Blech-Gripzange
Pince-étau pliage de tôle
Pinza regolabile autobloccante per lattonieri

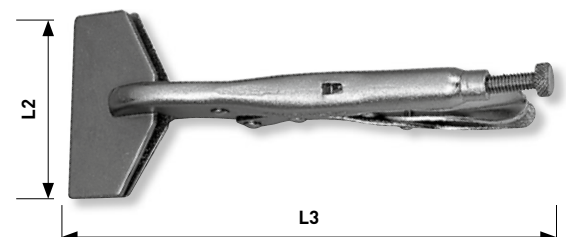
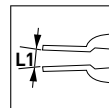

Art.	L1 mm	L2 mm	L3 mm / inch
2253-200	48	79	max. 200 / 8"

"C"- Grip-Klemmzange

Pince-étau col de cygne

Pinza regolabile autobloccante ganasce a collo di cigno

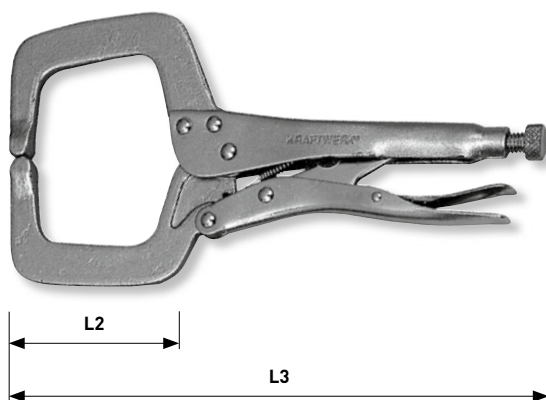
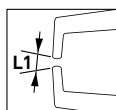

Art.	L1 mm	L2 mm	L3 mm / inch
2254-275	95	95	max. 275 / 11"

Revolverlochzange

Pince emporte pièces multi-diamètres

Pinza fustellatrice

Art.	Ø mm	L mm
4248-220	2 - 4.5	220



HIGHTECH

Hebelübersetzte Revolverlochzange

Pince emporte pièces multi-diamètres à levier

Pinza fustellatrice anti-sforzo

Art.	Ø mm	L mm
4248-250	2 - 4.5	250



HIGHTECH

Revolverloch- und Ösenzange

Pince emporte pièces multi-diamètres et à œillets

Pinza fustellatrice per occhielli metallici

Art.	Ø mm	L mm
4249-220	4 - 5	220



HIGHTECH

Hand-Blindnietzange

Pince à riveter

Rivettatrice manuale

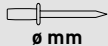
Art.	 \varnothing mm	L mm
2223	2.4-3.2-4.0-4.8	250

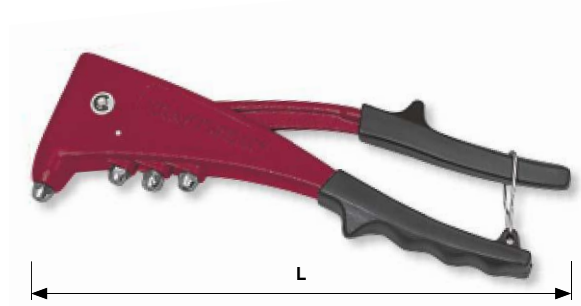



Hand-Blindnietzangen-Satz

Coffret pince à riveter

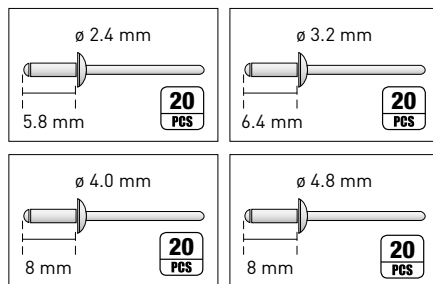
Set rivetti assortiti e rivettatrice

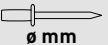

Art.	 \varnothing mm	 pcs.
2224	2.4-3.2-4.0-4.8	20



Hand-Blindnietzangen-Einsatz

Buse pour pince à riveter

Testina per rivettatrice manuale

Art.	\varnothing mm
2223-2.4	2.4
2223-3.2	3.2
2223-4.0	4.0
2223-4.8	4.8



Ersatz-Klemmbacken-Paar zu Hand-Blindnietzange

Paire de mâchoires de fixation pour pince à riveter

Paio di becchi di fissaggio per rivettatrice manuale

Art.
2223-01



Industrie-Handblindnietzangen-Satz
Coffret de pince à riveter industrielle
Set rivettatrice professionale e rivetti assortiti



HIGHTECH

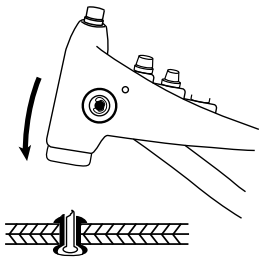

320 x 148 x 48 mm

Art.	\varnothing mm
4261	2.4-3.2-4.0-4.8

Hand-Blindnietzangen-Einsatz
Buse pour pince à riveter
Testina per rivettatrice manuale

Art.	\varnothing mm
4261-1	2.4
4261-2	3.2
4261-3	4.0
4261-4	4.8



Ersatz-Klemmbacken-Paar
zu Hand-Blindnietzange
Paire de mâchoires de fixation
pour pince à riveter
Paio di becchi di fissaggio
per rivettatrice manuale

Art.
4261-5



Industrie-Hebel-Handblindnietzangen-Satz
Coffret de pince à riveter industrielle à levier
Set di rivettatrice industriale di potenza



HIGHTECH

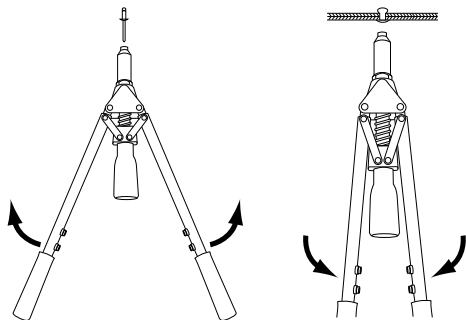

↕ 575 x 185 x 52 mm

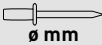
Art.	 mm
4262	3.2-4.0-4.8-6.0-6.4

Hand-Blindnietzangen-Einsatz
Buse pour pince à riveter
Testina per rivettatrice manuale

Art.	Ø mm
4262-1	3.2
4262-2	4.0
4262-3	4.8
4262-4	6.0
4262-5	6.4



Ersatz-Klemmbacken zu Hand-Blindnietzange
Mâchoires de fixation pour pince à riveter
Becchi di fissaggio per rivettatrice manuale

Art.
4262-7



Hand-Blindnietzangen-Einsatz Monobolt
Buse Monobolt pour pince à riveter
Testina Monobolt per rivettatrice manuale

Art.	Ø mm
4262-8	4.8/5 MB
4262-9	6.4mm MB



Industrie-Einnietmutternzangen-Satz
Coffret de pince à écrous aveugles industrielle
Set di inserti filettati con rivettatrice industriale



HIGHTECH

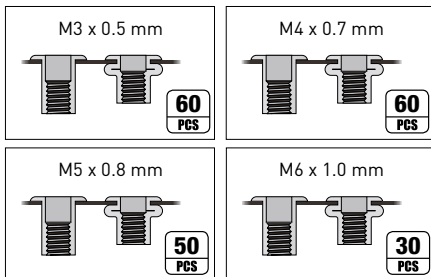

Art.	
4263	M3-M4-M5-M6



 320 x 148 x 48 mm

Hand-Blindnietzangen-Einsatz
Buse pour pince à riveter
Testina per rivettatrice

Art.	
4263-1	M3
4263-2	M4
4263-3	M5
4263-4	M6



Gewindedorn zu Einnietmutternzange
Embouchure pour pince à écrous aveugles
Mandrino di regolazione per inserti filettati

Art.	Ø
4263-5	M3
4263-6	M4
4263-7	M5
4263-8	M6



Industrie-Hebel-Einnietmutterngeräte-Satz
Coffret pince à écrous aveugles industrielle "2 mains"
Set di inserti filettati con rivettatrice di potenza



HIGHTECH

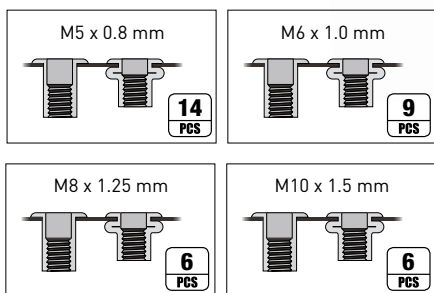

↕ 575 x 185 x 52 mm

Art.	
4264	M5-M6-M8-M10

Satz Mundstücke und Gewindedorne zu Hebel-Einnietmutterngerät
Jeu d'embouchures et de mandrins filetés pour pince à écrous aveugles
Set di testine e mandrini di regolazione per rivettatrice per inserti filettati di potenza

Art.	
4264-1	M4
4264-2	M5
4264-3	M6
4264-4	M8
4264-5	M10



Bolzenschneider

mit speziell geschliffenen Präzisionsschneiden aus Chrom-Molybdänstahl und ergonomischem 2-Komponenten-Griffen.

Pince coupe-boulons

avec lames en acier spécial chrome-molybdène poli pour une précision optimale. Manches ergonomiques bi-matière.

Troncabulloni

con tagliente di precisione al cromo-molibdeno e impugnatura ergonomica bimateriale.

Art.	15 HRC mm	35 HRC mm	L mm / inch
4260-18	8	6	450 / 18"
4260-24	10	8	600 / 24"
4260-30	13	10	750 / 30"
4260-36	16	11	900 / 36"
4260-42	18	13	1050 / 42"



HIGHTECH



Ersatz-Schneidkopf zu Bolzenschneider

Jeu complet de lames pour pinces coupe-boulons

Set lame per troncabulloni

Art.	L mm / inch
4260-18E	450 / 18"
4260-24E	600 / 24"
4260-30E	750 / 30"
4260-36E	900 / 36"
4260-42E	1050 / 42"

HIGHTECH



Draht- und Kabelschere

Cisailles à fils de fer et câbles

Mini cesoia tagliafilì

Art.	H mm	S mm	L mm
2262-07	2.5	4.0	195

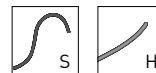

Gurtrohr- und Armaturenzange
Clé à sangle
Giratubo reversibile a nastro

Art.	∅ mm	L mm / inch
5418-300	0 - 225mm / 9"	300 / 12"





3 in 1 Mini-Bieger
Pince à cintrer 3 en 1
Pinza curvatubi 3 in 1

Art.	∅	C	L mm
5451	1/4" - 3/8" Cu / Me / Al	max. 180°	225



Kombi-Kabelschuhzange
Pince combinée pour cosses à câbles
Pinza per capicorda preisolati

Art.	 mm ²	 mm ²	L mm
2225	1.5 - 6	1.5 - 6	240

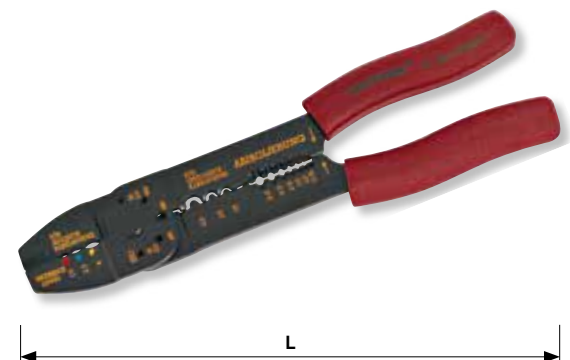

5-in-1 Kombi-Abisolier- und Kabelschuhzange



gehärtet und mit geschliffenen Schneiden für professionelle und industrielle Anwendungen.

Pinçe à sertir universelle

trempée avec des tranchants affûtés pour l'usage professionnel et industriel.

Pinza per capicorda preisolati 5-in-1

in acciaio indurito (54 HRC) e realizzata con bordi molati per un uso professionale e industriale.

Art.	 mm ²	 mm ²	L mm
3290-230	1.5 - 6	1.5 - 6	230

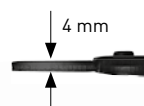

ERGOKRAFT

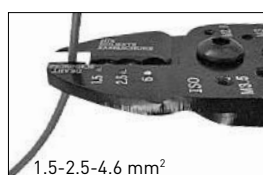

Kabelschneider
Coupe-câbles
Tronchese taglia fili



Quetschzange für isolierte Kabelschuhe
Sertissage pour cosse pré-isolées
Pinza a crimpare per terminali isolati



Bolzenschneider
Coupe-boulons
Troncabulloni

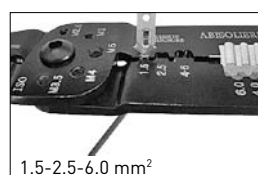

Quetschzange für nicht isolierte Kabelschuhe
Sertissage pour cosse nues
Pinza a crimpare per terminali a barre

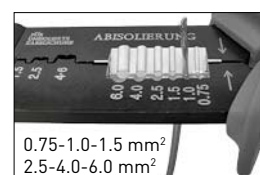

Abisolierzange für Kabel
Dénudage de câbles
Spelafili per cavi

Ratschen-Hebel-Crimpzange

mit auswechselbaren Crimpeinsätzen für Kabelschuhe und Kabelend-Hülsen.

Pinçe à cliquet pour cosse

avec mâchoires interchangeable pour cosse de câbles pré-isolées et cosse de câbles tubulaires et non isolées.

Pinza a cricchetto per capicorda professionale

con ganasce intercambiabili ed adattatori per terminali isolati, terminali non isolati e capicorda non isolati.

12
PCS



Art. 3254-01
DIN 0.5-1.0 / 1.5-2.5 / 4-6 mm²
AWG 22-18 / 16-14 / 12-10



Art. 3254-02
DIN 1.5 / 2.5 / 6 / 10 mm²
AWG 20-18 / 16-14 / 12-10 / 8
JIS 1.25 / 2 / 5.5 / 8 mm²

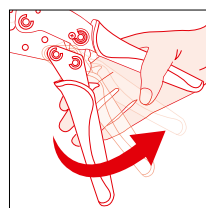
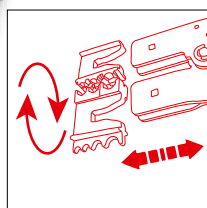

Art.	incl. 	L mm
3254	1x 3254-01 1x 3254-02	220

Ratschen-Hebel-Crimpzangenkoffer

mit auswechselbaren Crimpeinsätzen für isolierte Kabelschuhe und geschlossene, nicht isolierte Kabelschuhe und nicht isolierte Kabelendhülsen. Leerfächer für weitere Crimpeinsätze oder zum Aufbewahren von Kabelschuhen.

Coffret de pince à cliquet pour cosses

avec mâchoires interchangeables pour cosses de câbles pré-isolées et cosses de câbles tubulaires et non isolées. Compartiments vides pour mâchoires à sertir supplémentaires ou stockage des cosses.

Set di pinza a cricchetto per capicorda professionale

con ganasce intercambiabili ed adattatori per terminali isolati, terminali non isolati e capicorda non isolati. Gli scomparti vuoti possono essere utilizzati per le ganasce supplementari o per i terminali non utilizzati.



↕ 280 x 150 x 40 mm



Art. 3291-01
DIN 0.5-1.0 / 1.5-2.5 / 4-6 mm²
AWG 20-18 / 16-14 / 12-10



Art. 3291-02
DIN 1.5 / 2.5 / 6 / 10 mm²
AWG 20-18 / 16-14 / 12-10 / 8
JIS 1.25 / 2 / 5.5 / 8 mm²



Art.	incl. 	L mm
3291	1x 3291-01 1x 3291-02	220

Ratschen-Hebel-Crimpzange ohne Kopf

Pince à cliquet à sertir sans mâchoire

Pinza a cricchetto per capicorda senza ganasce



Art.	L mm
3291-220	220

Optionale Crimpeinsätze

Mâchoires à sertir supplémentaires

Ganasce intercambiabili opzionali



Art. 3291-03
DIN 0.5-1.0 / 1.5-2.5 / 4-6 mm²
AWG 20-18 / 16-14 / 12-10



Art. 3291-04
DIN 0.5 / 0.75 / 1.0 / 1.5 / 2.5 / 4.0 mm²
AWG 22 / 20 / 18 / 16 / 14 / 12



Art. 3291-05
Coaxial RG 58, 59, 62, 6.
6.48 / 5.41 / 2.5 / 1.72 / 8.23 mm²
0.255 / 0.213 / 0.1 / 0.68 / 0.324"



Art. 3291-06
DIN 6 / 10 / 16 mm²
AWG 10 / 8 / 6



Art. 3291-07
4P4C / RJ22



Art. 3291-08
6P2C / 6P4C / RJ11
6P6C / RJ12



Art. 3291-09
8P8C / RJ45



Art. 3291-10
DIN 2.5 / 0.5 / 8-10 mm²
AWG 14 / 22 / 8-6

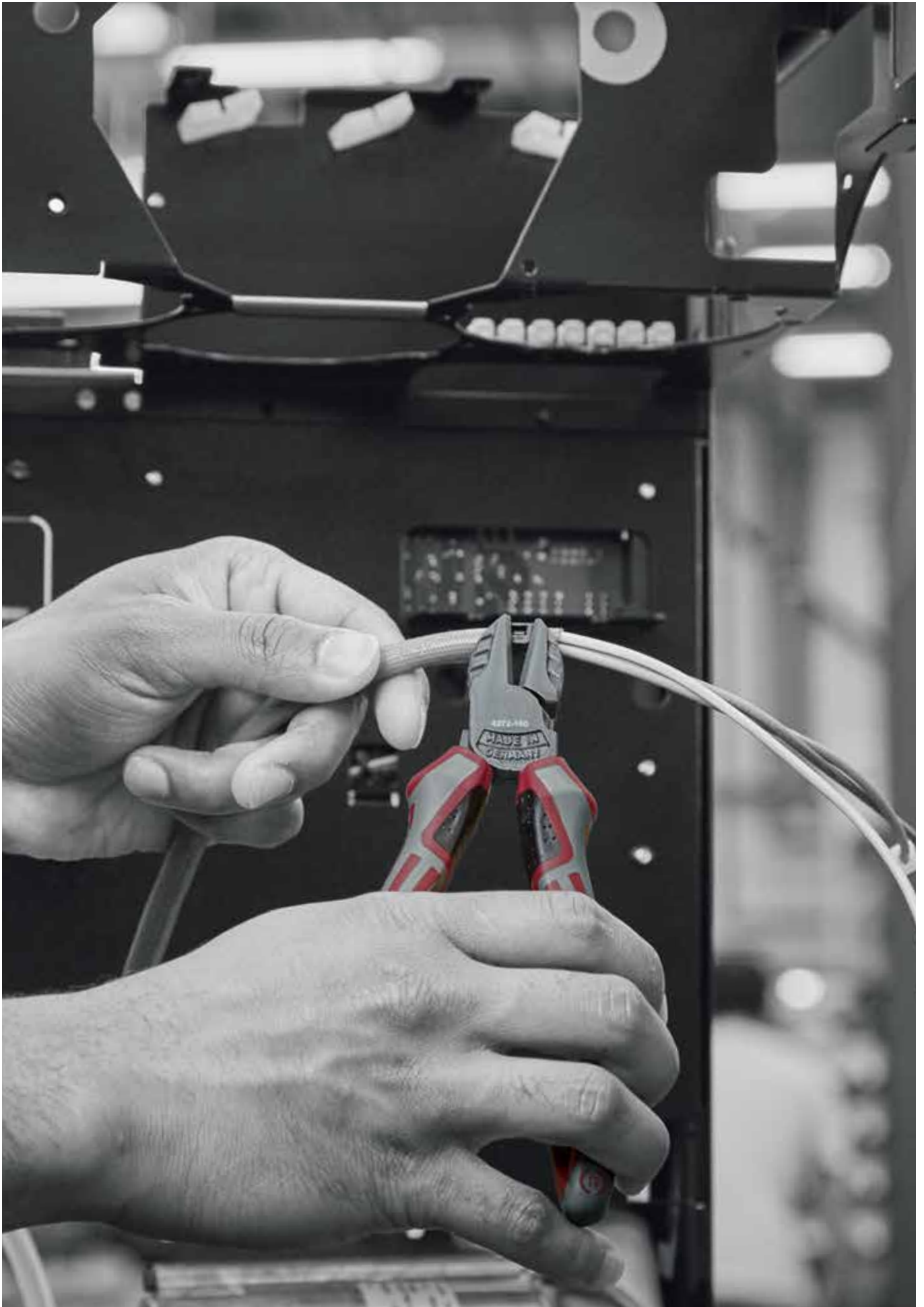



Trapezmesser

aus Metall mit 2-Komponentengriff, Klinge 3-stufig verstellbar, mit integriertem Schnurschneider sowie Klingen-Magazin mit 5 Ersatzklingen im Handgriff.

Couteau universel à lame trapézoïdale

en métal avec manche bi-matière, lame ajustable à 3 positions, coupe-fil intégré, 5 lames de rechange stockées dans le manche.

Cutter con lama trapezoidale

in metallo con impugnatura ergonomica e antiscivolo in bimatériale, regolazione lama a 3 posizioni, taglia corde integrato, dispenser con 5 lame trapezoidali di ricambio.

Art.	L mm
3301	180

Trapez-Klappmesser

mit ergonomischem, rutschhemmendem Zweikomponentengriff. Sicherheits-Schnellauswechsel-Mechanismus der Trapezklinge. Schnellver/-entriegelung des Klingenhalters. Inkl. 10 Trapezklingen mit Dispenser.

Couteau universel pliant à lame trapézoïdale

avec manche bi-matière antidérapant. Système de remplacement rapide de la lame pour une sécurité optimale. Verrouillage et déverrouillage rapide du porte-lame. Incl. étui de 10 lames trapézoïdales.

Cutter a serramanico con lama a trapezoidale

con impugnatura ergonomica e antiscivolo in bimatériale. Meccanismo di sicurezza per lo sgancio rapido della lama. Blocco/sblocco rapido della lama. Dispenser con 10 lame trapezoidali di ricambio.

Art.	L mm
3304	155

Sicherheits-Trapezmesser

aus Metall, mit Sicherheits-Rückzugfeder, die ein automatisches Zurückziehen der Klinge bewirkt, sobald der Griffknopf losgelassen wird.

Couteau de sécurité à lame trapézoïdale

en métal avec lame rétractable automatiquement dès qu'on relâche le bouton-poussoir.

Cutter di sicurezza a lama trapezoidaledi

in metallo e molla di sicurezza per richiamo automatico della lama a fine taglio.

Art.	L mm
3302	150

Ersatz-Trapezklingen-Satz

für Trapezmesser 3301, 3302 und 3304. Dispenser mit 5 Stück

Jeu de lames de rechange trapézoïdales

pour couteaux 3301, 3302 et 3304. Distributeur avec 5 pièces

Set lame trapezoidali

per cutter 3301, 3302 e 3304. Distributore con 5 pezzi

Art.	L mm	H mm
3303	65	19

ERGOKRAFT

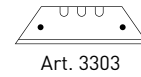
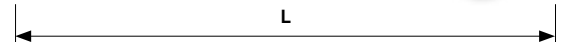

Art. 3303

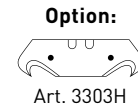

Art. 3303H

Option:



ERGOKRAFT

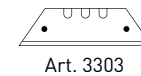
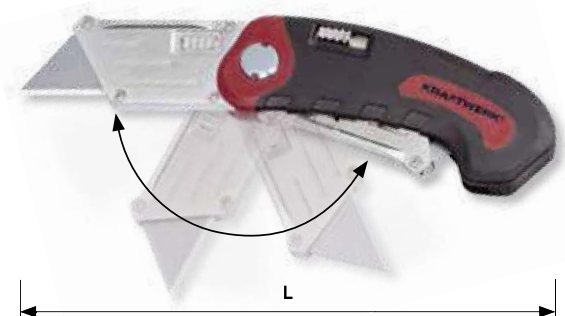

Art. 3303

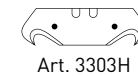

Art. 3303H

Option:

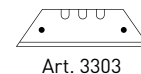
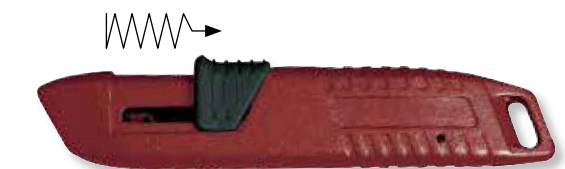

Art. 3303

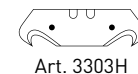

Art. 3303H

Option:

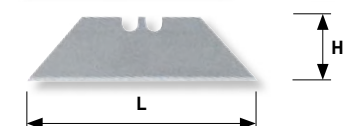

Ersatz-Hakenklingen-Satz

für Trapezmesser 3301, 3302 und 3304, Dispenser mit 5 Stück

Jeu de lames de rechange à crochet

pour couteaux 3301, 3302 et 3304. Distributeur avec 5 pièces

Set lame ad uncino

per cutter 3301, 3302 e 3304. Distributore con 5 pezzi

Art.	L mm	H mm
3303H	50	19

5
PCS

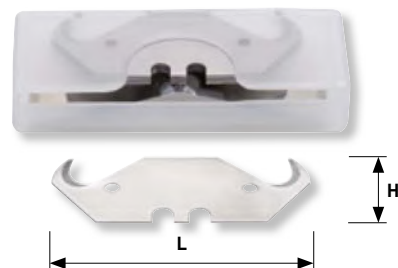

Abbrechklingen-Messer

Ergonomisches Kunststoffgehäuse mit weicher Griffzone, Inox-Klingenführung, automatische Klingenarretierung. Inklusive 3 Klingen.

Cutter à lame sécable

Manche ergonomique en ABS avec revêtement soft. Chariot de guidage de lame en Inox, avec molette de blocage de la lame. Inclus 3 lames sécables.

Cutter universale a lame a settori

Impugnatura ergonomica antiscivolo in ABS. Guida lama in acciaio inossidabile, ghiera bloccalama. Incluso 3 lame a settore.

Art.	L mm
3310	135

ERGOKRAFT

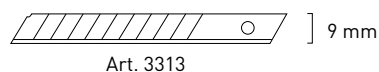

Art. 3313

Abbrechklingen-Messer

mit solidem Metallgehäuse, Inox-Klingenführung, automatische Klingenarretierung.

Cutter à lame sécable

avec manche solide en métal. Chariot de guidage de lame en Inox, avec molette de blocage de la lame.

Cutter universale a lame a settori

con impugnatura solida in metallo. Guida lama in acciaio inossidabile, ghiera bloccalama.

Art.	L mm
3317	130

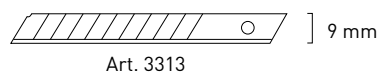
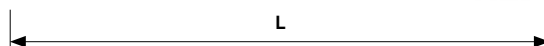

Art. 3313

Inox-Abbrechmesser

mit schlankem Gehäuse, integrierter Sicherheits-Arretierung und Metallclip

Cutter universel en inox

avec verrouillage de lame de sécurité et clip de poche en acier

Cutter universale a lame a settori in inox

con anima extra piatta, ghiera bloccalama e clip da tasca metallica

Art.	L mm
3311	129

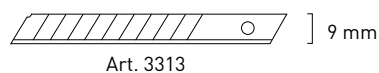
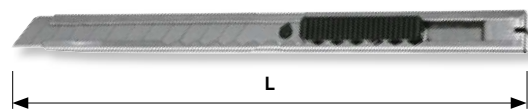

Art. 3313

Abbrechklingen

mit 12 Segmenten pro Klinge, 10 Stück in solidem Plastikköcher

Lames sécables de rechange

12 sections par lame, 10 pièces dans un étui solide en plastique

Lame a settore di ricambio

con 12 segmenti per lama, 10 pezzi in custodia solida

Art.	L mm	H mm
3313	85	9

Abbrechklingen-Messer

Ergonomisches Kunststoffgehäuse mit weicher Griffzone, Inox-Klingenführung, automatische Klingenvorschub und Klingennarretierung. Inklusive 6 Klingen.

Cutter à lame sécable

Manche ergonomique en ABS avec revêtement soft. Chariot de guidage de lame en Inox, avec rechargement automatique de lame et molette de blocage de la lame. Inclus 6 lames sécables.

Cutter universale a lame a settori

Impugnatura ergonomica antiscivolo in ABS. Guida lama in acciaio inossidabile, caricamento automatico della lama nuova e ghiera bloccalama. Incluso 6 lame a settore.

Art.	L mm
3312	165

Abbrechklingen-Messer

Ergonomisches Kunststoffgehäuse mit weicher Griffzone, Inox-Klingenführung, Klingennarretierung mit Stellrad. Inklusive 3 Klingen.

Cutter à lame sécable

Manche ergonomique en ABS avec revêtement soft. Chariot de guidage de lame en Inox, avec roulette de blocage de la lame. Inclus 3 lames sécables.

Cutter universale a lame a settori

Impugnatura ergonomica antiscivolo in ABS. Guida lama in acciaio inossidabile, rotella bloccalama. Incluso 3 lame a settore.

Art.	L mm
3315	167

Abbrechklingen-Messer

mit solidem Metallgehäuse, Inox-Klingenführung, automatische Klingennarretierung.

Cutter à lame sécable

avec manche solide en métal. Chariot de guidage de lame en Inox, avec molette de blocage de la lame.

Cutter universale a lame a settori

con impugnatura solida in metallo. Guida lama in acciaio inossidabile, ghiera bloccalama.

Art.	L mm
3318	155

10
PCS

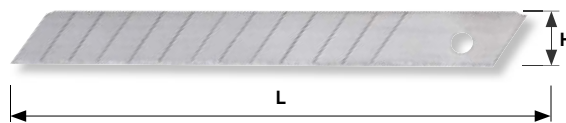

ERGOKRAFT

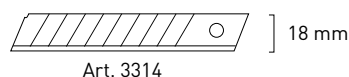
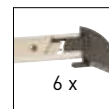

ERGOKRAFT

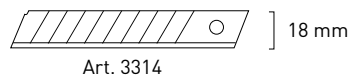
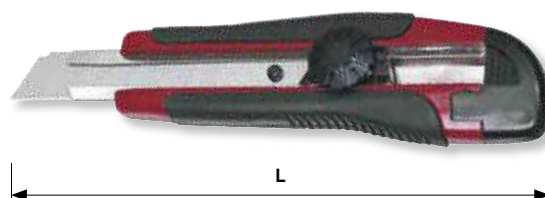

Abbrechklingen

mit 7 Segmenten pro Klinge, 10 Stück in solidem Plastikköcher

Lames sécables de recharge

7 sections par lame, 10 pièces dans un étui solide en plastique

Lame a settore di ricambio

con 7 segmenti per lama, 10 pezzi in custodia solida

Art.	L mm	H mm
3314	109	18

10
PCS

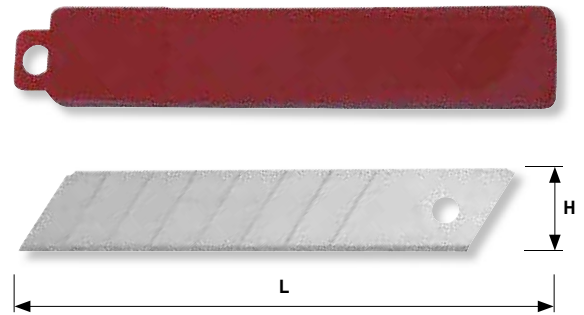

Universal-Klappmesser

mit matter Edelstahl Klinge, Sicherheitsverriegelung, Aluminiumverschalung und Clip auf der Rückseite.

Couteau à cran d'arrêt

avec lame mate en acier inoxydable, mécanisme bloque-lame poignée en aluminium et clip au verso.

Coltello universale a serramanico

con lama in acciaio inossidabile a finitura opaca e meccanismo di bloccaggio. Impugnatura in alluminio e clip sul retro.

Art.	L1 mm	L2 mm
3323	112	188

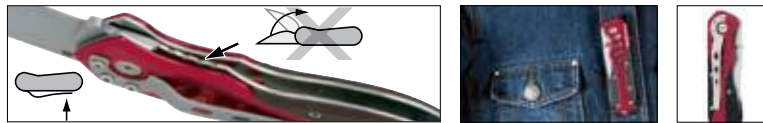

Multifunktions-Werkzeug-Satz mit Taschenmesser

zusammenklappbar, Zangenkopf mit Drahtschneider, 8 funktionelle Klingen in den Griffschalen. Geliefert in praktischem Nylon-Gürteletui.

Pince multifonction pliante

Tête de pince avec coupe-fil, 8 lames d'outils intégrés dans les poignées. Livré avec un couteau de poche du même style dans étui ceinture en nylon.

Utensile multiuso tascabile

pinza trancia/spela cavi metallici, 8 lame funzionali integrati all'interno del manico. Corredato con coltellino e astuccio da cintura in nylon.

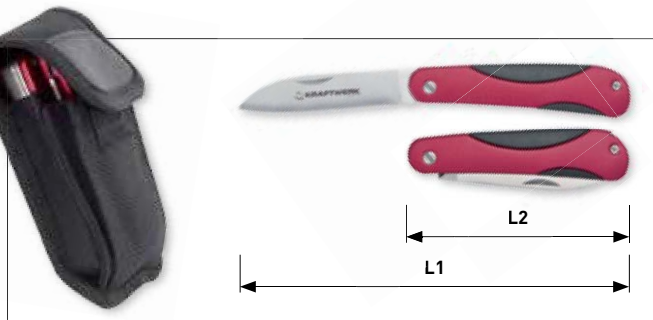

Art.	L1 mm	L2 mm	L3 mm	L4 mm
3322	188	112	100	160

Kabel- und Elektrikermesser

mit Doppelklinge

Couteau d'électricien

avec double lame

Coltellino a serramanico da elettricista

con doppia lama

Art.	L mm
3325	190

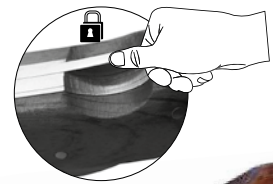

Seglermesser

Couteau de marin

Coltello da vela



Art.
3324



Abmantelungs-Werkzeug

besonders geeignet für größere Querschnitte und für schwer zu bearbeitende Isolierwerkstoffe

Outils à dégainer

idéal pour les grosses sections et les matériaux isolants difficiles à travailler

Utensile spelacavi

particolarmente adatto per sezioni di grandi dimensioni e per materiali isolanti di difficile lavorazione



Art.	Ø mm ²	L mm
2230	8 - 28	142



Rohrschneider für Kunststoffrohre
Coupe-tubes pour tubes en plastique
Tagliatubi per tubi di plastica

Art.	∅ mm	∅ inch	L mm
5441	0 - 42	0 - 1-5/8	190

PP, PE, PEX, PB, PVDF



Ersatzschneidmesser

zu Art. 5441

Lame de rechange

pour art. 5441

Lama di ricambio

per art. 5441

Art.	H mm	L mm
5441E	30	105



Rohrabschneider

für Kupfer-, Messing-, Aluminium- und dünnwandige Stahlrohre.
 Ausklappbarer Innenentgrater.

Coupe-tube à coulisseau

pour tubes en cuivre, laiton, aluminium et acier de faible épaisseur.
 Ebavureur pivotant intégré.

Tagliatubi per rame e leghe leggere

per tubi in rame, ottone, alluminio, sottili pareti di tubi in acciaio.
 Sbattole per tubi serramanico.

Art.	∅ mm	L mm
5432	Cu/Al/Me 3 - 32	150

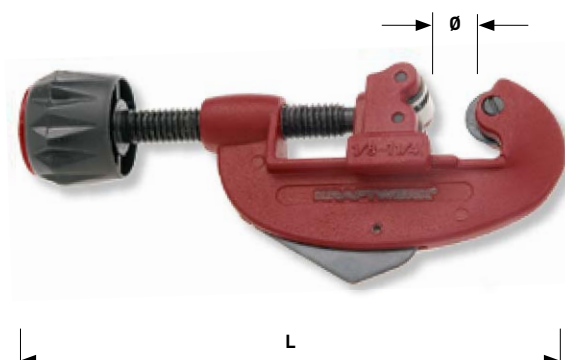

Teleskop-Rohrabschneider

Für präzises Arbeiten an engen Stellen. Schnellverstellung, versenkbarer Rohr-Innenentgrater.

Coupe-tube télescopique

Pour travaux précis dans des endroits inaccessibles. Ajustement rapide. Ebavureur pivotant intégré.

Tagliatubi telescopico

Uso preciso in spazi limitati. Regolazione rapida. Sbavatore per tubi integrato.



Art.	Ø mm	L mm
5436	Inox 6 - 42	170



Schneidrädchen zu Rohrabschneider

Molette pour coupe-tubes

Lama tagliatubi

Art.	Mat.	Ø mm	L mm
5440-1	Cu/Al/Me	18	2.9

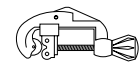

Art. 5432

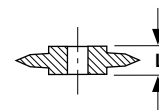

Schneidrädchen zu Rohrabschneider

Molette pour coupe-tubes

Lama tagliatubi

Art.	Mat.	Ø mm	L mm
5440-3	Cu/Al/Me	18	6.0
5440-5	Inox	18	6.0

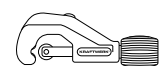

Art. 5436

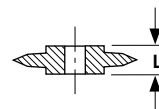

Schneidrädchen zu Rohrabschneider

Molette pour coupe-tubes

Lama tagliatubi

Art.	Mat.	Ø mm	L mm
5440-5ES	Inox	18	6.0

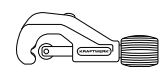

Art. 5436

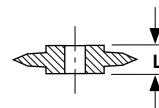



Rohrentgrater

für innen- und aussen

Ebavureur tonneau

pour intérieur et extérieur

Sbavatore a botte

per interno ed esterno

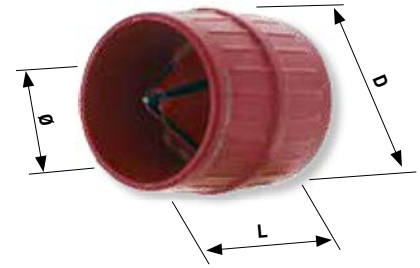

Art.	Ø mm	D mm	L mm
5470	6 - 40	52	55

Mini-Schaber

Mini grattoir

Mini raschietto

Art.	
3338	
3338E	Ersatzklingen / recharge / ricambio

10
PCS



Universal-Schere

Cisailles universelles

Forbice universale

Art.	L mm
2240	185



ERGOKRAFT



Elektriker-Schere
Cisailles pour l'électricien
Forbice per elettricisti

Art.	L mm
2251	142



Figuren-Blechscherer
 links schneidend, Zweikomponenten-Handgriffe
Cisailles à tôles bichantourneuses
coupe à gauche, manches bi-matière
Cesoia a doppia leva
 taglio sinistro, impugnature bimatériauale

Art.	L mm	HRC	∠MH mm	Inox 80kg/mm ² mm
2241	250	58 - 60	1.2	0.8

CrMo

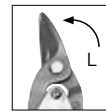

Figuren-Blechscherer
 rechts schneidend, Zweikomponenten-Handgriffe
Cisailles à tôles bichantourneuses
coupe à droite, manches bi-matière
Cesoia a doppia leva
 taglio destro, impugnature bimatériauale

Art.	L mm	HRC	∠MH mm	Inox 80kg/mm ² mm
2242	250	58 - 60	1.2	0.8

CrMo

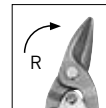

Figuren-Blehschere

gerade schneidend, Zweikomponenten-Handgriffe

Cisailles à tôles bichantourneuses

coupe droite, manches bi-matière

Cesoia a doppia leva

taglio diritto, impugnature bimateriale

Art.	L mm	HRC	∠ MH mm	Inox 80kg/mm ² mm
2243	250	58 - 60	1.2	0.8

CrMo

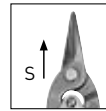

Figuren-Blehscheren-Satz

Jeu de cisailles à tôles bichantourneuses

Set cesoia a doppia leva

Art.	L mm	HRC	∠ MH mm	Inox 80kg/mm ² mm
2244	250	58 - 60	1.2	0.8

CrMo

3 PCS



Figuren- und Durchlaufschere

links schneidend, Zweikomponenten-Handgriffe

Cisailles démultipliées chantourneuses

coupe à gauche, manches bi-matière

Cesoia passante a doppia leva

taglio sinistro, impugnature bimateriale

Art.	L mm	HRC	∠ MH mm	Inox 80kg/mm ² mm
2245	240	58 - 60	1.2	0.8

CrMo

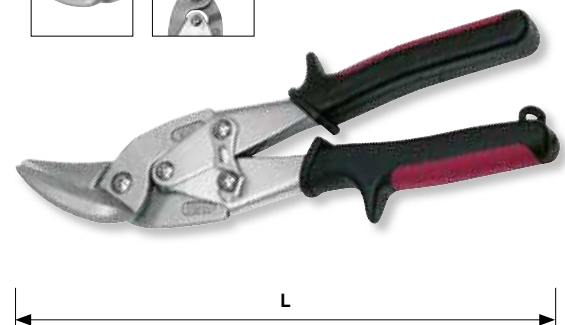

Figuren- und Durchlaufschere

rechts schneidend, Zweikomponenten-Handgriffe

Cisailles démultipliées chantourneuses

coupe à droite, manches bi-matière

Cesoia passante a doppia leva

taglio destro, impugnature bimateriale

Art.	L mm	HRC	∠ MH mm	Inox 80kg/mm ² mm
2246	240	58 - 60	1.2	0.8

CrMo

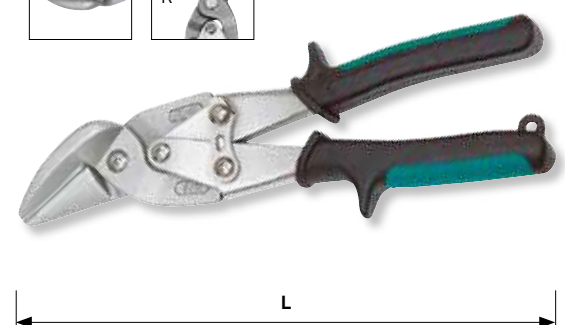
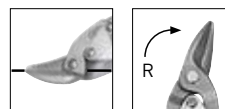

Metallsägebogen

mit HSS Bimetall-Sägeblatt, Zweikomponentengriff und Sägeblatt-Schnellwechsel-Vorrichtung

Monture de scie à métaux

avec lame en ASR bi-métal, manche bi-matière et avec système de changement rapide de lame

Seghetto

con lama in HSS bimetale, impugnatura bimeriale e lama a ricambio rapido

Art.	L1 mm	L2 mm
3305	300	400

 Art. 3316

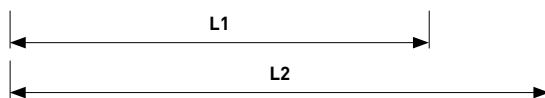
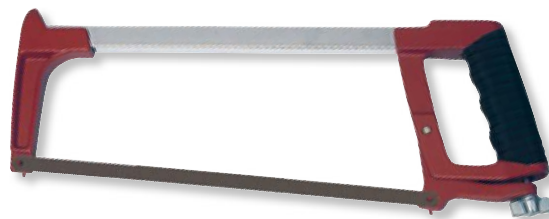

Metallsägeblatthalter

mit Zweikomponenten-Handgriff

Monture à manche pour lame de scie à métaux

avec manche bi-matière

Seghetto mono-impugnatura

con impugnatura bimeriale

Art.	L1 mm	L2 mm
3308-1	163	315

 Art. 3316

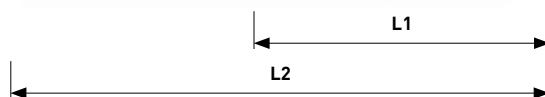



ERGOKRAFT

Handsägeblatt

Lame de scie à métaux

Lama per seghetto

Art.	L mm		
3316-18	300	7	18
3316-24	300	10	24
3316-32	300	13	32



DIN 6494 / ISO 2336-1

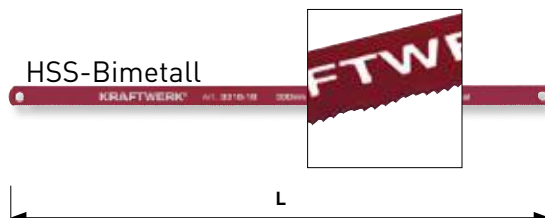

Mini-Sägebogen

Monture mini pour lame de scie à métaux

Miniseghetto

Art.	L1 mm	L2 mm
3309	150	250

 Art. 3319

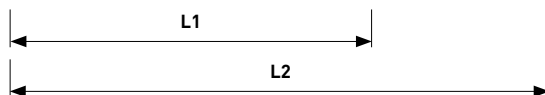

Mini-Handsägeblatt

Lame de scie à métaux mini

Lama per miniseghetto

Art.	L mm		
3319	150	10	24



Flachfeile

Halbschlicht, mit Zweikomponenten-Handgriff

Lime plate emmanchée

demi-douce, avec manche bi-matière

Lima piatta

a taglio mezzodolce, con impugnatura bimateriale

Art.	L1 mm	L2 mm
4320-1	200	320

Halbrundfeile

Halbschlicht, mit Zweikomponenten-Handgriff

Lime demi-ronde emmanchée

demi-douce, avec manche bi-matière

Lima mezzotonda

a taglio mezzodolce, con impugnatura bimateriale

Art.	L1 mm	L2 mm
4320-2	200	320

Rundfeile

Halbschlicht, mit Zweikomponenten-Handgriff

Lime ronde emmanchée

demi-douce, avec manche bi-matière

Lima tonda

a taglio mezzodolce, con impugnatura bimateriale

Art.	L1 mm	L2 mm
4320-3	200	320

Vierkantfeile

Halbschlicht, mit Zweikomponenten-Handgriff

Lime carrée emmanchée

demi-douce, avec manche bi-matière

Lima quadrata

a taglio mezzodolce, con impugnatura bimateriale

Art.	L1 mm	L2 mm
4320-4	200	320

Dreikantfeile

Halbschlicht, mit Zweikomponenten-Handgriff

Lime triangulaire emmanchée

demi-douce, avec manche bi-matière

Lima triangolare

a taglio mezzodolce, con impugnatura bimateriale

Art.	L1 mm	L2 mm
4320-5	200	320

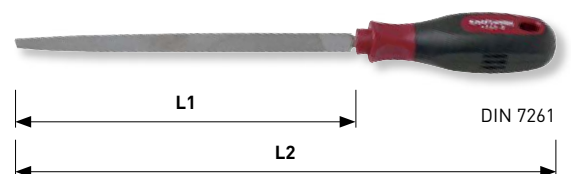
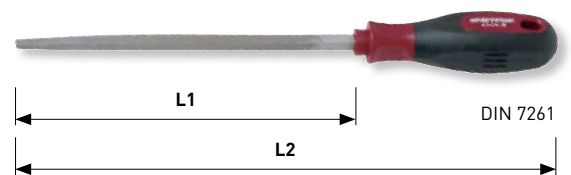
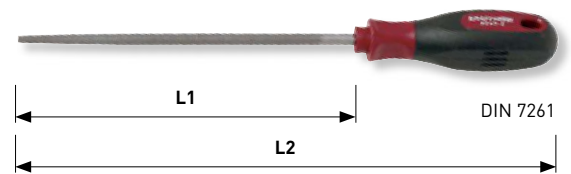
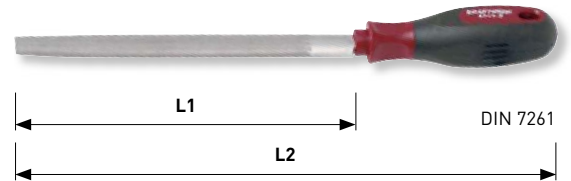
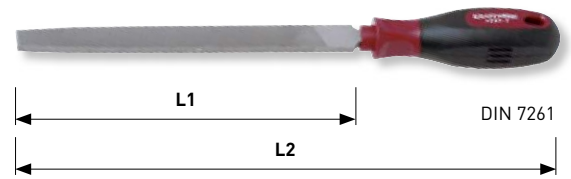

Werkstattfeilen-Satz

Halbschlicht, mit Zweikomponenten-Handgriffen

Jeu de limes d'atelier

demi-douces, avec manches bi-matière

Assortimento di lime

a taglio mezzodolce, con impugnature bimatériauale

Art.
4320

Art. 4320-1
Art. 4320-2
Art. 4320-3
Art. 4320-4
Art. 4320-5



Nadelfeilen-Satz

Assortiment de limes aiguilles

Set lime ago

Art.	L1 mm
4321	165



Drahtbürste

V2A, 4-reihig

Brosse métallique

V2A, 4-rangs, avec manche bi-matière

Spazzola con fili d'acciaio

V2A, 4 file

Art.	L1 mm
4325	260

Drahtbürste

V2A, mit Holzgriff, 4-reihig

Brosse métallique

V2A, 4 rangs, manche en bois

Spazzola a fili d'acciaio

V2A, 4 file, impugnatura in legno

Art.	L1 mm
4326	290

T12

5
PCS

ERGOKRAFT



DIN 7261

T12

6
PCS

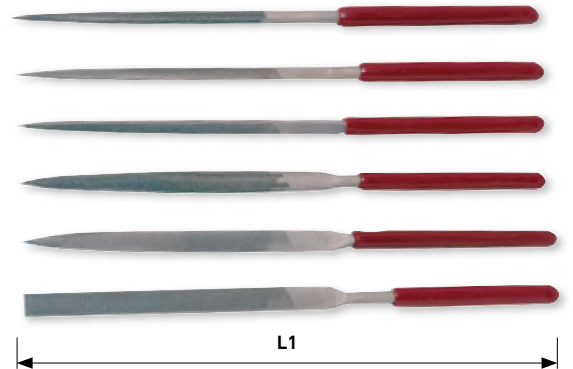

inox

ERGOKRAFT



inox

4x15





Sicherheits-Schlosserhammer

Kopf schwarz lackiert, mit polierten Arbeitsflächen, Stahl-Stielschutzhülse, fein lackiertem, doppelt geschweiftem amerikanischem Hickory-Hartholzstiel. Dauerhaft fester Stielsitz durch Stahlkeil und zusätzlicher Epoxy-Sicherheitsverleimung.

Marteau type serrurier de sécurité

tête laquée noir, faces polies, avec bague de protection du manche en acier, manche hickory à double partie bombée et vernie. Fixation permanente du manche par coins en métal et collage époxy de sécurité.

Martello di sicurezza, tipo tedesco

testa laccata nera, superfici frontali levigate lucide, bussola salvamanico in acciaio, manico sagomato in legno duro Hickory americano, laccato. Bloccaggio del manico con cuneo in acciaio e resina epossidica.

Art.	g	L1 mm	L2 mm	L3 mm
2301	100	82	15	262
2302	200	95	19	282
2303	300	105	23	302
2304	400	112	25	312
2305	500	118	27	322
2308	800	130	33	343
2310	1000	135	36	362
2315	1500	145	42	382

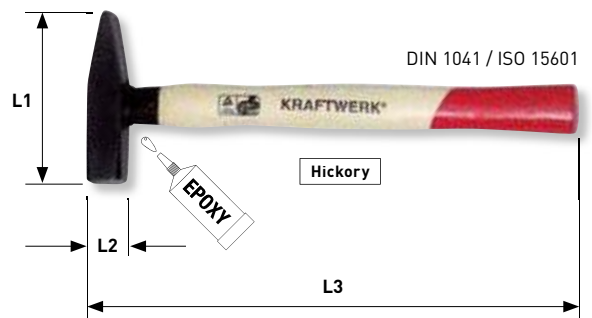

Sicherheits-Schlosserhammer

Kopf schwarz lackiert, mit polierten Arbeitsflächen und schlagfestem Zweikomponenten-Fiberglas-Stiel. Dauerhaft fester Stielsitz durch Stahlkeil und zusätzlicher Epoxy-Sicherheitsverleimung.

Marteau type serrurier de sécurité

tête laquée noir, faces polies, manche en fibre de verre bi-matière résistant aux chocs et poignée ergonomique de sécurité en caoutchouc. Fixation permanente du manche par coins en métal et collage époxy de sécurité.

Martello di sicurezza, tipo tedesco

testa laccata nero, superfici frontali levigate lucide, manico in fibra di vetro bimatereale resistente agli urti. Fissaggio permanente della maniglia Bloccaggio del manico con cuneo in acciaio e resina epossidica.

Art.	g	L1 mm	L2 mm	L3 mm
2385	300	105	23	300
2387	500	118	27	315

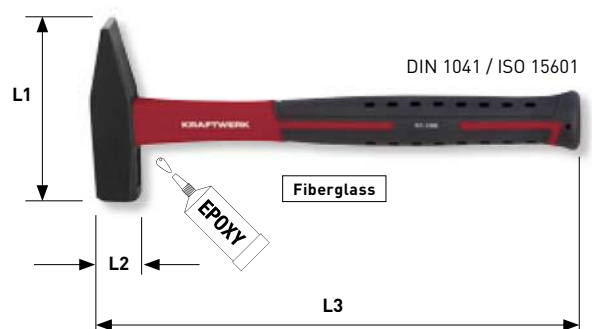

Sicherheits-Fäustel

Kopf schwarz lackiert, mit polierten Arbeitsflächen und schlagfestem Zweikomponenten-Fiberglas-Stiel. Dauerhaft fester Stielsitz durch Stahlkeil und zusätzlicher Epoxy-Sicherheitsverleimung.

Masse de sécurité

tête laquée noir, faces polies, manche en fibre de verre bi-matière résistant aux chocs et poignée ergonomique de sécurité en caoutchouc. Fixation permanente du manche par coins en métal et collage époxy de sécurité.

Mazzetta di sicurezza

testa laccata nero, superfici frontali levigate lucide, manico in fibra di vetro bimatereale resistente agli urti. Fissaggio permanente della maniglia Bloccaggio del manico con cuneo in acciaio e resina epossidica.

Art.	 g	L1 mm	L2 mm	L3 mm
2390	1000	95	40	260
2392	1250	100	43	260
2395	1500	110	45	280

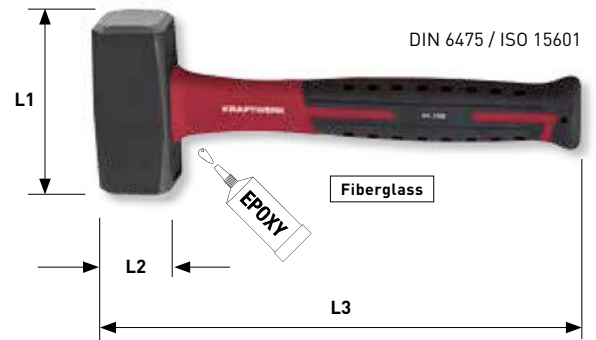

Ganzstahl-Sicherheits-Schlosserhammer

unzerstörbar, mit rutschfestem, ergonomischem 2-Komponenten-Handgriff

Marteau de sécurité type serrurier, forgé en une seule pièce d'acier

indestructible, avec poignée ergonomique et revêtement antidérapant

Martello di sicurezza, tipo tedesco, completamente in un unico pezzo in acciaio

indistruttibile, impugnatura bimatereale ergonomica e antiscivolo

Art.	 g	L1 mm	L2 mm	L3 mm
2319	500	118	27	330

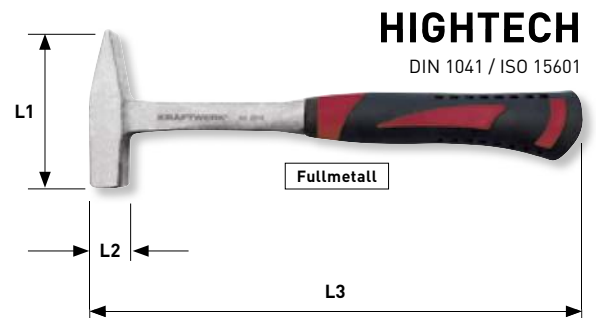

Schlosserhammer französische Form

Kopf schwarz lackiert, mit polierten Arbeitsflächen, fein lackiertem, doppelt geschweiftem amerikanischem Hickory-Hartholzstiel. Dauerhaft fester Stielsitz durch Stahlkeil und zusätzlicher Epoxy-Sicherheitsverleimung.

Marteau de mécanicien type rivoir

tête laquée noir, faces polies, manche en hickory à double partie bombée et vernie. Fixation permanente du manche par coins en métal et collage époxy de sécurité.

Martello da fabbro, tipo francese

testa laccata nera, superfici frontali levigate lucide, bussola salvamanico in acciaio, manico sagomato in legno duro Hickory americano, laccato. Bloccaggio del manico con cuneo in acciaio e resina epossidica.

Art.	 g	L1 mm	L2 mm	L3 mm
2354	250	82	26	265
2355	300	86	28	280

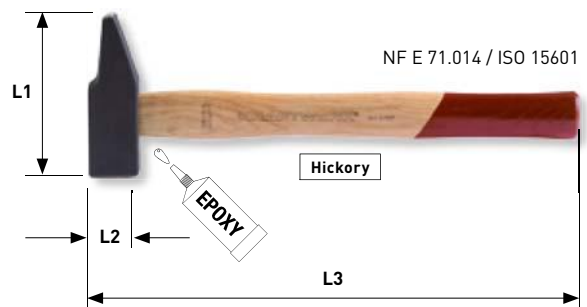

Schlosserhammer französische Form

Kopf schwarz lackiert, mit polierten Arbeitsflächen und schlagfestem Zweikomponenten-Fiberglas-Stiel. Dauerhaft fester Stielsitz durch Stahlkeil und zusätzlicher Epoxy-Sicherheitsverleimung.

Marteau de mécanicien type rivoir

tête laquée noir, faces polies, manche en fibre de verre bi-matière résistant aux chocs et poignée ergonomique de sécurité en caoutchouc. Fixation permanente du manche par coins en métal et collage époxy de sécurité.

Martello da fabbro, tipo francese

testa laccata nera, superfici frontali levigate lucide, manico in fibra di vetro bimatériale resistente agli urti. Fissaggio permanente della maniglia Bloccaggio del manico con cuneo in acciaio e resina epossidica.

Art.	 g	L1 mm	L2 mm	L3 mm
2376	400	94	30	307
2378	630	104	36	325
2380	860	110	40	362
2381	1000	118	42	362
2383	1600	140	50	374

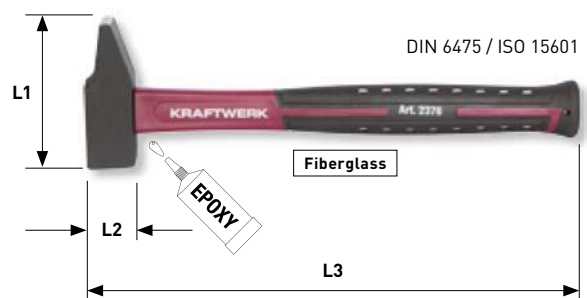

Sicherheits-Fäustel

Kopf schwarz lackiert, mit polierten Arbeitsflächen, Stahl-Stielschutzhülse, fein lackiertem amerikanischem Hickory-Hartholzstiel. Dauerhaft fester Stielsitz durch Stahlkeil und zusätzlicher Epoxy-Sicherheitsverleimung.

Masse de sécurité

tête laquée noir, faces polies, avec bague de protection en acier, manche en hickory verni. Fixation permanente du manche par coins en métal et collage époxy de sécurité.

Mazzetta di sicurezza

testa laccata nera, testa levigata lucida, bussola salvamanico in acciaio, manico sagomato in legno duro Hickory americano, laccato. Bloccaggio del manico con cuneo in acciaio e resina epossidica.

Art.	g	L1 mm	L2 mm	L3 mm
2339	800	92	37	260
2340	1000	95	40	260
2342	1250	100	43	260
2345	1500	110	45	280

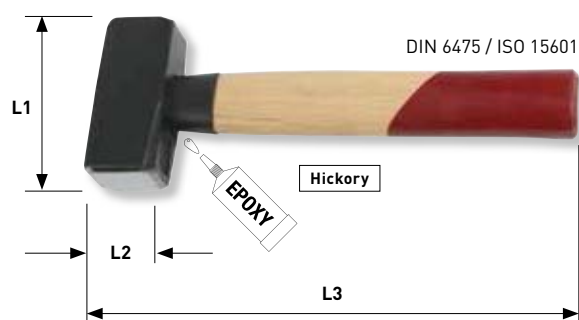

Englischer Schlosserhammer (Ingenieurhammer)

Kopf schwarz lackiert, mit polierten Arbeitsflächen, fein lackiertem amerikanischem Hickory-Hartholzstiel. Dauerhaft fester Stielsitz durch Stahlkeil und zusätzlicher Epoxy-Sicherheitsverleimung.

Marteau de mécanicien tête boule

tête laquée noir, faces polies, manche en hickory à double partie bombée et vernie. Fixation permanente du manche par coins en métal et collage époxy de sécurité.

Martello con testa tonda e penna sferica

testa laccata nera, superfici frontali levigate lucide, bussola salvamanico in acciaio, manico sagomato in legno duro Hickory americano, laccato. Bloccaggio del manico con cuneo in acciaio e resina epossidica.

Art.	g	L1 mm	L2 mm	L3 mm
2351	1130 / 40oz	137	40	400
2352	1360 / 48oz	147	42	400

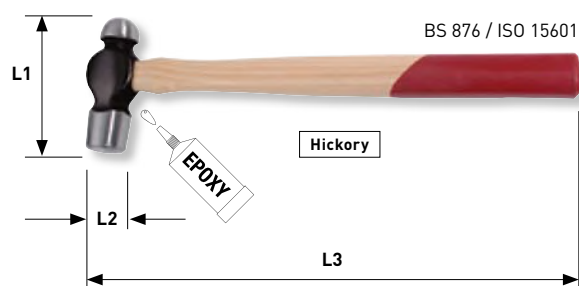

Klauenhammer, französische Form

Kopf schwarz lackiert, mit schlagfestem Zweikomponenten-Fiberglas-Stiel. Dauerhaft fester Stielsitz durch Stahlkeil und zusätzlicher Epoxy-Sicherheitsverleimung.

Marteau de coffreur, modèle français

tête laquée noir, manche en fibre de verre bi-matière résistant au choc. Fixation permanente du manche par coins en métal et collage époxy de sécurité.

Martello a granchio, modello francese

testa laccata nera, manico in fibra di vetro bimatériale resistente agli urti. Fissaggio permanente della maniglia Bloccaggio del manico con cuneo in acciaio e resina epossidica.

Art.	g	L1 mm	L2 mm	L3 mm
2366	600	140	27	320

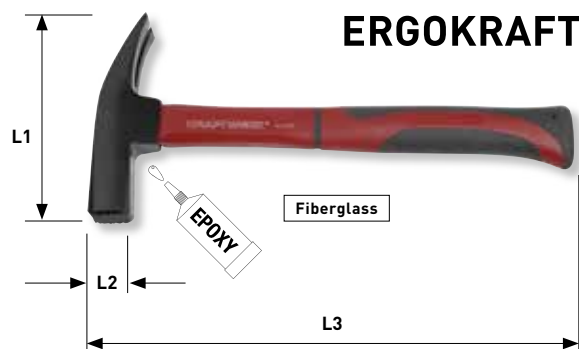

Klauenhammer, amerikanische Form

Kopf blank poliert, mit schlagfestem Zweikomponenten-Fiberglas-Stiel. Dauerhaft fester Stielsitz durch Stahlkeil und zusätzlicher Epoxy-Sicherheitsverleimung.

Marteau de coffreur, modèle américain

tête polie, manche en fibre de verre bi-matière résistant aux chocs. Fixation permanente du manche par coins en métal et collage époxy de sécurité.

Martello a granchio, modello americano

testa levigata lucide, manico in fibra di vetro bimatereale resistente agli urti. Fissaggio permanente della maniglia Bloccaggio del manico con cuneo in acciaio e resina epossidica.

Art.	g	L1 mm	L2 mm	L3 mm
2368	450	132	29	320

ERGOKRAFT

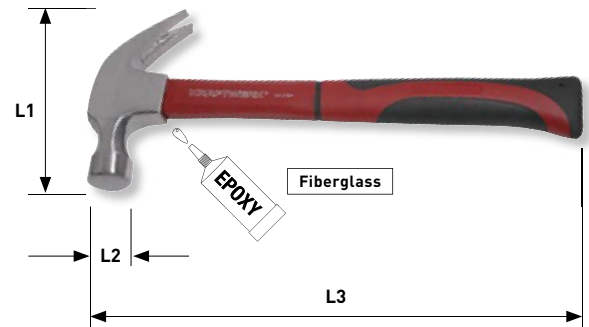

Schonhammer

mit Einsätzen aus zähem Nylon und Polyurethan, fein lackiertem amerikanischem Hickory-Hartholzstiel. Dauerhaft fester Stielsitz durch Stahlkeil und zusätzlicher Epoxy-Sicherheitsverleimung.

Massette à embouts interchangeables

en nylon dur et polyuréthane. Manche en hickory à double partie bombée et vernie. Fixation permanente du manche par coins en métal et collage époxy de sécurité.

Mazzuola in nylon

con teste intercambiabili in nylon duro ed poliuretano, manico sagomato in legno duro Hickory americano, laccato. Bloccaggio del manico con cuneo in acciaio e resina epossidica.

Art.	g	L1 mm	L2 mm	L3 mm
2336	360	98	35	305

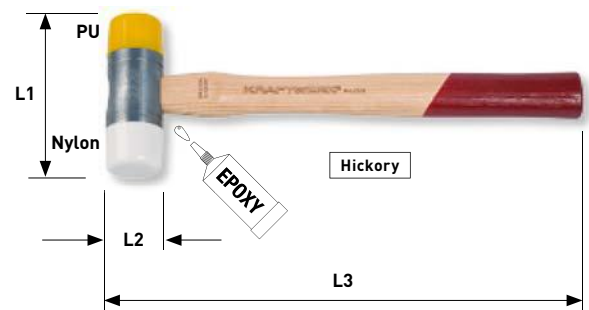

Ersatzkopf Nylon

zu Kunststoffhammer 2336

Embout nylon

pour massette 2336

Testa di ricambio in nylon

per mazzuola 2336

Art.	g	L1 mm	L2 mm
2336NY	55	24	35

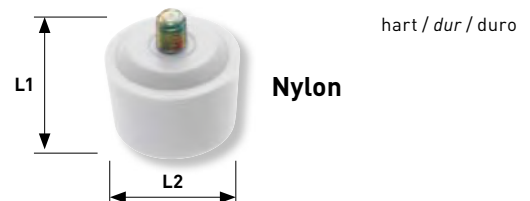

Ersatzkopf Polyurethan

zu Kunststoffhammer 2336

Embout en polyuréthane

pour massette 2336

Testa di ricambio in poliuretano

per mazzuola 2336

Art.	g	L1 mm	L2 mm
2336PU	55	24	35

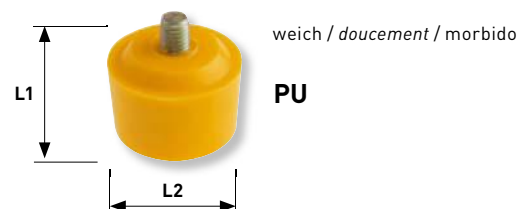

Latthammer

Kopf schwarz lackiert, mit magnetischem Nagelhalter, mit schlagfestem Fiberglas-Stiel und ergonomischem Sicherheits-Gummigriff.

Marteau de charpentier

tête laquée noir, avec porte-clou magnétique, manche en fibre de verre bi-matière résistant aux chocs et poignée ergonomique de sécurité en caoutchouc.

Martello falegname

testa laccata nera, con portachiodo magnetico, manico infrangibile in fibra di vetro con impugnatura anatomica in materiale sintetico morbido.

Art.	 g	L mm
2320	600	325



Gipserbeil

Kopf lackiert, polierte Schneide, mit Nagelauszieher, mit speziell gehärtetem Stahlrohrstiel und ergonomischem Sicherheits-Gummigriff.

Hache de plâtrier et de maçon

tête laquée, avec arrache-clou, manche en tube acier trempé et poignée en caoutchouc ergonomique de sécurité.

Accetta per carpentieri

testa laccata, con estrattore di chiodi, manico tubolare in acciaio con impugnatura anatomica in materiale sintetico morbido.

Art.	 g	L mm
2323	600	315

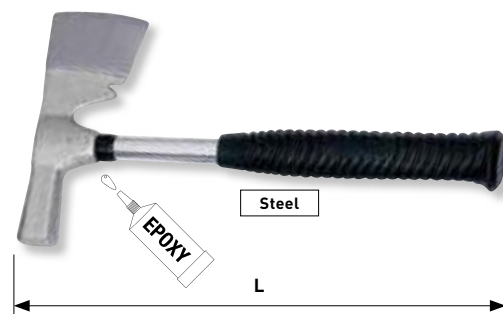

Splintentreiber

voll poliert

Chasse-goupilles

poli miroir

Cacciaspina

lucidata

Art.	 mm	L mm
3350-2	2	115
3350-3	3	125
3350-4	4	150
3350-5	5	165
3350-6	6	180
3350-8	8	180

CrMo



DIN 6450 Form C

Splintentreibersatz

voll poliert, mit Werkzeughalter

Jeu de chasse-goupilles

polis miroir, avec porte-outils

Assortimento di cacciaspine

lucidate, con porta-utensile

Art.	∅ mm		L mm
3350	2-3-4-5-6-8		115-125-150-165-180-180

Art. 3350-2	2 mm
Art. 3350-3	3 mm
Art. 3350-4	4 mm
Art. 3350-5	5 mm
Art. 3350-6	6 mm
Art. 3350-8	8 mm

CrMo

**6
PCS**



DIN 6450 Form C

Splintentreiber

einbrennlackiert

Chasse-goupilles

thermolaqué

Cacciaspina

termolaccato

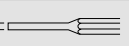
Art.	∅ mm		L mm
1350-2	2		115
1350-3	3		125
1350-4	4		150
1350-5	5		165
1350-6	6		180
1350-8	8		180

CrV



DIN 6450 Form C

Durchschlag

voll poliert

Chasse-pointes

poli miroir

Punzone

lucidato

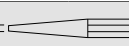
Art.	∅ mm		L mm
3355-2	2		120
3355-3	3		120
3355-4	4		120
3355-5	5		120
3355-6	6		120

CrMo



DIN 6458

Durchschlag-Satz

voll poliert, mit Werkzeughalter

Jeu de chasse-pointes

polis miroir, avec porte-outils

Assortimento di punzoni

lucidate, con porta-utensile

Art.	Ø mm		L mm
3355	2-3-4-5-6		120

Art. 3355-2	2 mm
Art. 3355-3	3 mm
Art. 3355-4	4 mm
Art. 3355-5	5 mm
Art. 3355-6	6 mm

CrMo

5
PCS



DIN 6458

Körner

voll poliert

Pointeau

poli miroir

Bulino

lucidato

Art.	Ø mm		L mm
3358-1	3		100
3358-2	4		120

CrMo



DIN 7250

Flachmeissel, achtkant

voll poliert

Burin plat, octogonal

poli miroir

Scalpello piatto, ottagonale

lucidato

Art.	L1 mm	L2 mm
3365-12	12	130
3365-18	18	165

CrMo



DIN 6453

Flachmeissel

einbrennlackiert

Burin plat

thermolaqué

Scalpello piatto

termolaccato

Art.	B mm	L mm
3380-18	18	125
3380-22	22	155

CrV



DIN 6451/53

Kreuzmeissel, achtkant

voll poliert

Bédane, octogonal

poli miroir

Scalpello ad unghietta, ottagonale

lucidato

Art.	L1 mm	L2 mm
3368-5	5	130
3368-7	7	165

CrMo



DIN 6451

Meissel-/Splintentreiber-/Durchschlag-Satz

voll poliert, mit Werkzeughalter

Jeu de burins chasse-pointes et chasse-goupilles

polis miroir, avec porte-outils

Assortimento di cacciaspine, punzoni e scalpelli

lucidate, con porta-utensile

Art.
3370

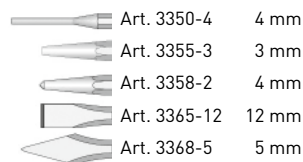

CrMo

**5
PCS**



Meissel-/Splintentreiber-/Durchschlag-Satz

voll poliert, mit Werkzeughalter

Jeu de burins chasse-pointes et chasse-goupilles

polis miroir, avec porte-outils

Assortimento di cacciaspine, punzoni e scalpelli

lucidate, con porta-utensile in metallo

Art.
3374

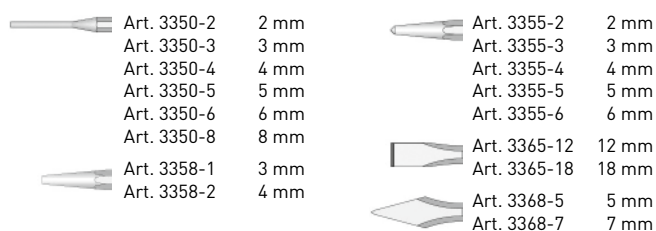

CrMo

**17
PCS**



Automatik-Körner
Pointeau automatique
Bulino automatico

Art.	L mm
3359	132

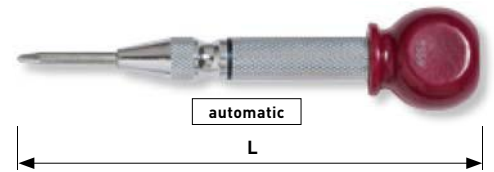

Ersatzspitze mit Feder

für Automatik-Körner 3359

Pointe et ressort de rechange

pour pointeau automatique 3359

Punta di ricambio con molla

per bulino automatico 3359

Art.	L mm
3359E	-



Parallel-Stahl-Schraubstock

gesenkgeschmiedet, mit Drehteil und Rohrspannbacken, auswechselbare, gehärtete Spannbacken, vorwärtsöffnend, mit Ambos und Horn, schwarz lackiert. Backen, Führung und Amboss geschliffen und gehärtet.

Étau d'établi en acier

forgé, avec base tournante et mâchoires à tuyaux, mâchoires en acier interchangeables, s'ouvrant vers l'avant, avec enclume et corne, laquée noir. Mâchoires, glissière et enclume aiguisées en acier trempé.

Morsa parallela da banco

in acciaio forgiato, con piede girevole e ganasce per il serraggio di tubi, ganasce indurite intercambiabili, apertura in avanti, con incudine e corno, laccato nero. Ganasce, guida e incudine affilati ed induriti.



Art.	L1 mm	L2 mm	L3 mm	g
2961	100	120	65	7.5
2962	125	140	70	11
2963	150	170	80	14.5
2964	200	200	90	20.5

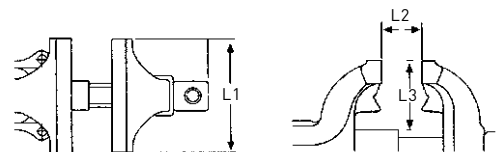

Ersatzbacken

zu Parallel-Stahl-Schraubstock

Mâchoires de rechange

pour étau d'établi en acier

Ganasce di ricambio

per morsa parallela da banco

Art.
2961E
2962E
2963E
2964E



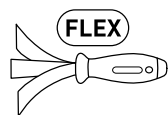
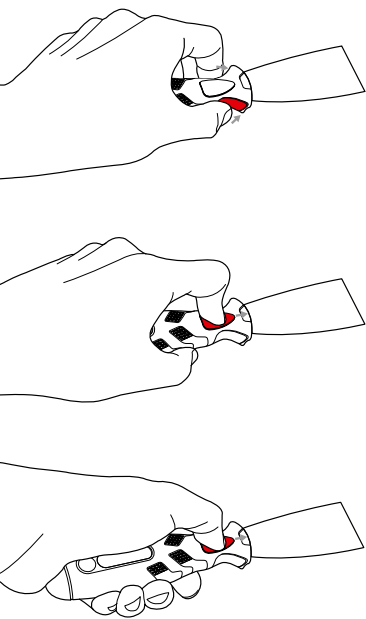

Universalspachtel

- flexibles Blatt aus rostfreiem Stahl, gehärtet und spiegelpoliert
- 2-Komponenten-Softgriff mit abrutschsicheren Griffmulden

Spatule universelle

- lame souple en inox, renforcée et polie miroir
- manche bi-matière antidérapant

Spatola universale

- lama flessibile in acciaio inox, temperata e lucidata
- impugnatura in bimatereale per una presa sicura



Art.	B mm	L1 mm	L2 mm
3331-032	32	105	240
3331-050	50	105	245
3331-063	63	105	245
3331-075	75	105	245
3331-100	100	105	245
3331-125	125	105	245

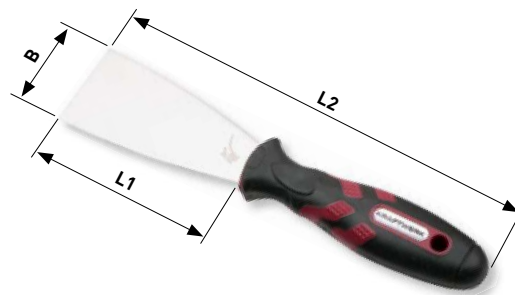

Universalspachtel-Satz

- flexible Blätter aus rostfreiem Stahl, gehärtet und spiegelpoliert
- 2-Komponenten-Softgriffe mit abrutschsicheren Griffmulden

Jeu de spatules universelles

- lames souples en inox, renforcées et polies miroir
- manches bi-matière antidérapants

Assortimento di spatole universali

- lame flessibili in acciaio inox, temperate e lucidate
- impugnature in bimatereale per una presa sicura



Art. 3331-032	32 mm
Art. 3331-050	50 mm
Art. 3331-075	75 mm

Art.	B mm
3335	32 - 50 - 75



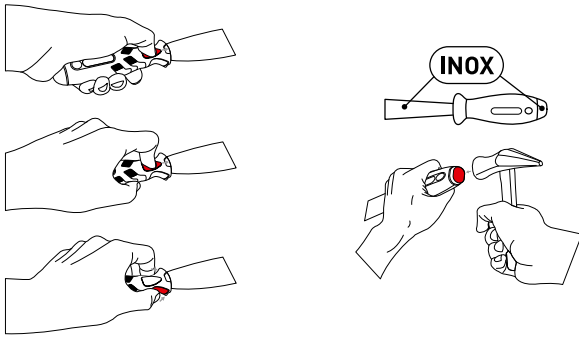

Schab- und Schlagspachtel

- stabile Meisselklinge aus rostfreiem Stahl, gehärtet und spiegelpoliert
- 2-Komponenten-Softgriff mit abrutschsicheren Griffmulden und INOX-Schlagkappe

Spatule grattoir

- lame traversante en inox, renforcée et polie miroir
- manche bi-matière anti-dérapant et zone de frappe en inox

Spatola a battere

- lama in acciaio inox indurito e impugnatura in bimatereale per una presa sicura
- la testa del manico è dotato di cappuccio in acciaio inox

Art.	B mm	L1 mm	L2 mm
3332-032	32	105	240
3332-075	75	105	245



inox



Schab- und Schlagspachtel, gekröpft

- stabile Meisselklinge aus rostfreiem Stahl, gehärtet und spiegelpoliert
- 2-Komponenten-Softgriff mit abrutschsicheren Griffmulden und INOX-Schlagkappe

Spatule grattoir

- lame traversante en inox, renforcée et polie miroir
- manche bi-matière anti-dérapant et zone de frappe en inox

Spatola a battere, ad angolo

- lama in acciaio inox indurito e impugnatura in bimatereale per una presa sicura
- la testa del manico è dotato di cappuccio in acciaio inox

Art.	B mm	L1 mm	L2 mm
3333-032	32	98	235
3333-075	75	110	240

inox



Schab- und Schlagspachtel-Satz

- stabile Meisselklingen aus rostfreiem Stahl, gehärtet und spiegelpoliert
- 2-Komponenten-Softgriffe mit abrutschsicheren Griffmulden und INOX-Schlagkappen

Jeu de spatules grattoirs

- lame traversante en inox, renforcée et polie miroir
- manche bi-matière anti-dérapant et zone de frappe en inox

Serie di spatole a battere

- lame in acciaio inox indurito e impugnature in bimatereale per una presa sicura
- la testa del manico è dotato di cappuccio in acciaio inox

Art.	B mm
3336	32/15° - 32 - 75

inox

3
PCS





Taschen-Rollmeter

klein und handlich, mit Schlüsselanhänger

Mètre à ruban de poche

petit et maniable, avec porte-clé

Flessometro con attacco per cintura

piccolo e maneggevole, con portachiavi

Art.	L/M 	B/mm 	↕ mm
4701-0206	2 m x 6 mm	6	47 x 46 x 12



Rollmeter

ABS-Kunststoffgehäuse verchromt, mit Gummischutz.
Stahlband mm-Teilung, gelb lackiert und nylonbeschichtet.
Bandfeststeller. Gürtelklemme abnehmbar. Genauigkeitsklasse II.

Mètre à ruban

Boîtier en ABS chromé, avec protection en caoutchouc. Ruban en acier avec graduation en mm, verni jaune, revêtu nylon. Blocage du ruban. Agrafe de ceinture amovible. Classe de précision II.

Flessometro cromato

Corpo in ABS cromato, con protezione in gomma. Nastro in acciaio con graduazione in mm, verniciato giallo e rivestito in nylon, scala graduata nella parte inferiore e superiore. Bloccaggio del nastro. Attacco per cintura rimovibile. Classe di precisione II.

Art.	L/M 	B/mm 	↕ mm
4701-0316	3	16	61 x 53 x 25
4701-0519	5	19	71 x 64 x 29

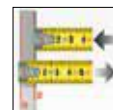

Rollmeter

Extra breites, schockabsorbierendes Massband, 2-seitig beschriftet mit mm-Teilung, nylonbeschichtet. Grosser Endhaken mit 2 Magneten, robustes ABS-/Gummi-Gehäuse.

Mètre à ruban

Extra large, rouleau anti-chocs, graduation en mm sur les 2 faces, revêtement nylon. Crochet extra large en bout de ruban avec 2 aimants, coque solide en ABS / Caoutchouc.

Flessometro

Extra larghi, protezione anti shock, scala graduata doppia in mm, rivestimento in nylon. Gancio grande con 2 magneti, robusta custodia in gomma ABS.

Art.	L/M 	B/mm 	↕ mm
4706-0319	3	19	62 x 62 x 29
4706-0527	5	27	72 x 72 x 41
4706-0827	8	27	82 x 82 x 41

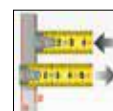

Rollmeter

Stahlband mit automatischer Rücklaufsperrung und mm-Teilung, ABS-Gehäuse.

Mètre à ruban

Ruban en acier avec verrouillage automatique et graduation en mm, coque ABS

Flessometro

Nastro in metallo con blocco automatico della posizione, corpo in ABS.

Art.	L/M	B/mm	↕ mm
4706-0313	3	13	62 x 62 x 27

ABS

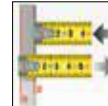

Stahlbandmass

Geschlossenes ABS-Kunststoffgehäuse mit robustem Gummischutz. Stahlband nylonbeschichtet mit mm- und cm-Teilung. Band-Schnellrücklauf dank einklappbarer Kurbel. Genauigkeitsklasse II.

Mètre à ruban long en acier

Boîtier en ABS fermé avec protection solide en caoutchouc. Ruban en acier avec graduation en mm et cm, verni jaune, revêtu nylon. Enroulement rapide du ruban grâce à la manivelle rabattable. Classe de précision II.

Rotella metrica

Custodia in plastica ABS con robusta protezione in gomma. Nastro in acciaio rivestito in nylon con graduazione in mm e cm. Rapido riavvolgimento del nastro alla posizione di arresto grazie alla manovella richiudibile. Classe di precisione II.

Art.	L/M	B/mm	↕ mm
4712-109.5	10	9.5	85 x 83 x 20

ABS

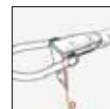

Glasfaserbandmass

Geschlossenes ABS-Kunststoffgehäuse. Hochwertiges, unzerbrechliches Fiberglas-Band mit cm-Teilung. Band-Schnellrücklauf dank einklappbarer Kurbel. Genauigkeitsklasse III.

Mètre à ruban long en fibre de verre

Boîtier en ABS fermé. Ruban en fibre de verre incassable de haute qualité avec graduation en cm sur les deux faces. Enroulement rapide du ruban grâce à la manivelle rabattable. Classe de précision III.

Rotella metrica

Custodia in plastica ABS. Nastro infrangibile rivestito in fibra di vetro di alta qualità con graduazione in cm. Rapido riavvolgimento del nastro alla posizione di arresto grazie alla manovella richiudibile. Classe di precisione III.

Art.	L/M	B/mm	↕ mm
4716-1013	10	13	114 x 113 x 20

ABS

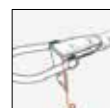

Stahlbandmass

Schlagfester ABS-Kunststoffrahmen. Stahlband nylonbeschichtet mit mm- und cm-Teilung. Band-Schnellrücklauf dank einklappbarer Kurbel mit 3-facher Übersetzung beim Aufrollen des Massbandes. Genauigkeitsklasse II.

Mètre à ruban long en acier

Support en matière plastique ABS résistant aux chocs. Ruban en acier avec graduation en mm et cm, verni jaune, revêtu nylon. Enroulement rapide du ruban grâce à la manivelle rabattable à triple démultiplication. Classe de précision II.

Bindella in acciaio

Telaio in ABS resistente allo choc. Nastro in acciaio e rivestito in nylon con graduazione in mm e cm. Rapido riavvolgimento del nastro alla posizione di arresto grazie alla manovella richiudibile. Classe di precisione II.

Art.	$\frac{L}{M}$	B/mm
4711-3013	30	13

ABS

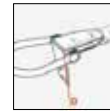

Stahl-Massstab

Präzisionsteilung in mm und 1/2 mm, biegsam, rostfrei, mattierte Teilung. Genauigkeitsklasse II.

Réglet en acier

Graduation précise en mm et en 1/2 mm, flexible, inoxydable, traitement antireflet. Classe de précision II.

Riga in acciaio

Graduazione precisa in mm e 1/2 mm, flessibile, inossidabile, esecuzione antiriflesso. Classe di precisione II.

Art.	B/mm	L mm
2976	28	300

inox

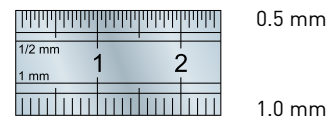
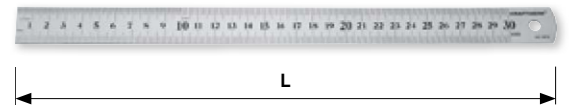

Stahl-Flachwinkel

ohne Anschlag, geschliffen

Équerre simple en acier

sans chapeau, rectifiée

Squadra semplice in acciaio

senza cappello, rettificata

Art.	L1 mm	L2 mm
2978	100	70

inox

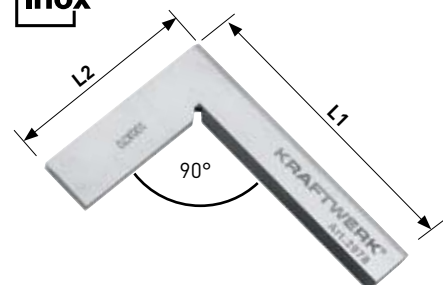

DIN 875

Schieblehre

Edelstahl rostfrei, gehärtet und feinstgeschliffen, mit Kreuzspitzen, Nonius und Skala mattverchromt, mit Feststellschraube, Tiefenmass 150 mm, in Kunststoffkasten.

Pied à coulisse

en acier inox, trempé et rectifié, vernier et échelle chromés mats, blocage du vernier par vis, mesures intérieures, extérieures et de profondeur 150 mm, en coffret.

Calibro a corsoio

in acciaio inossidabile, temprato e rettificato di precisione, con punte a croce, nonio e scala cromati opachi, con vite di fermo, per misurazioni di profondità fino a 150 mm, in robusto astuccio di plastica.

Art.	$\frac{L}{mm}$	$\frac{\text{eye}}{mm}$	L mm
2970	0-150 6"	0.05 1/128"	230

inox

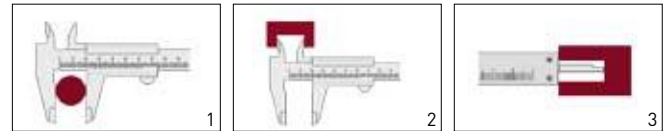
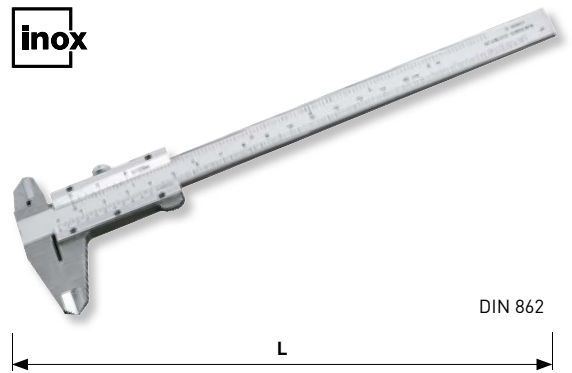

- 1 Aussenmessung / Mesure extérieure / Misurazione esterna
- 2 Innenmessung / Mesure intérieure / Misurazione interna
- 3 Tiefenmessung / Mesure de profondeur / Misurazione della profondità

Digital-Schieblehre

mit Feststellschraube, Ablesung umschaltbar mm - Zoll, 5-stellige LCD-Anzeige, Nulleinstellung in jeder Position möglich, für Aussen-, Innen- und Tiefenmessungen. In Kunststoffkasten.

Pied à coulisse digital

avec vis de blocage, lecture en mm - ou en pouce, affichage-LCD 5-chiffres, remise à zéro possible dans toutes les positions, pour mesures intérieures, extérieures et de profondeur. Livré en coffret.

Calibro corsoio digitale

con vite di fermo, lettura in mm - pollici, display LCD a 5 cifre, azzeramento possibile in ogni posizione, per misurazioni di esterni, interni e di profondità. In robusto astuccio di plastica.

2.09 digital inox

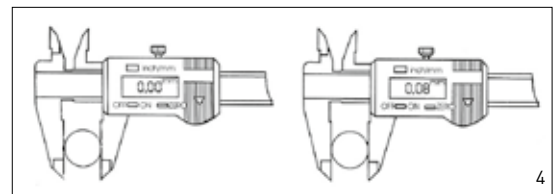
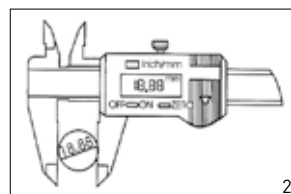
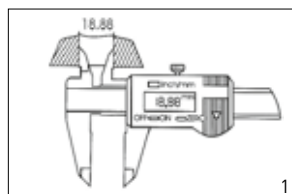
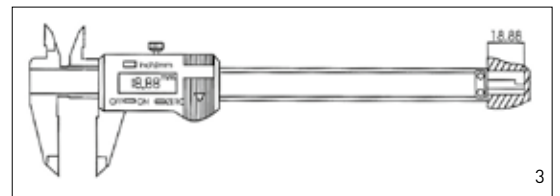
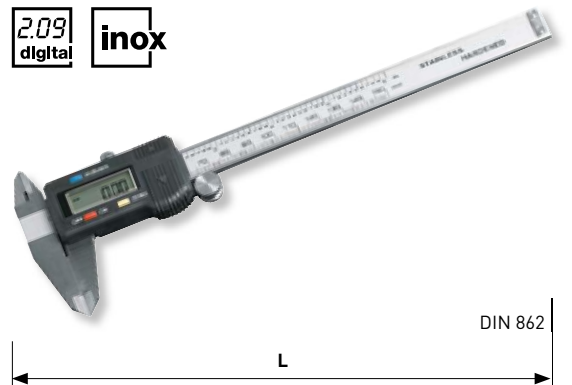

- 1 Messungen der inneren Abmessungen
Les mesures des dimensions intérieures
Misura delle dimensioni interne
- 2 Messungen der äusseren Abmessungen
Les mesures des dimensions extérieures
Misura di dimensioni esterne
- 3 Messungen der Tiefe
Les mesures de la profondeur
Le misurazioni della profondità
- 4 Differenzmessverfahren
(Die Anwendung der Nullstellung)
L'application de la position zéro
(L'applicazione della posizione zéro)
- 5 Messung der Schritte
La mesure des étapes
Misurazione dei passi

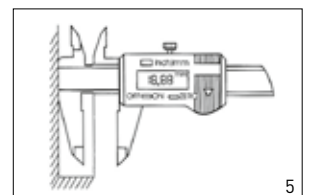

Aussen-Mikrometer

Hartmetallbestückte Messflächen, mit Friktionskupplung und Feststellschraube

Micromètre d'extérieur

Surfaces de mesure en métal dur, avec limiteur de couple à friction et vis de blocage

Micrometro per esterni

Superfici in metallo duro, con frizione a cricchetto e vite di fermo

Art.	L/mm	mm	L mm
2975	0-25	0.01	135

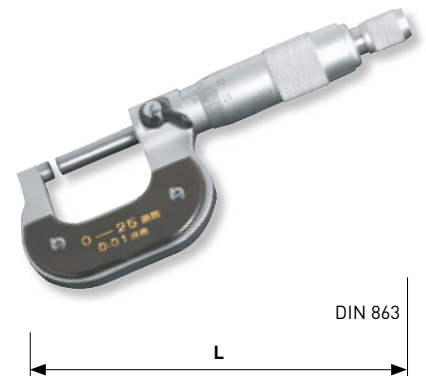

Präzisions-Messwerkzeug-Satz

- Digital-Schieblehre 0-150 mm/0-6"
- Aussen-Mikrometer 0-25 mm/0.01 mm
- Flachwinkel 100 x 70 mm
- Stahlmassstab 300 mm

Jeu d'instruments de mesure

- Pied à coulisse digital 0-150 mm/0-6"
- Micromètre d'extérieur 0-25 mm/0.01 mm
- Équerre simple 100 x 70 mm
- Règlet semi-rigide inox 300 mm

Assortimento di utensili di misura di precisione

- Calibro digitale 150 mm/0-6"
- Micrometro per esterni 0-25 mm/0,01 mm
- Squadra 100 x 70 mm
- Riga in acciaio da 300 mm

2.09 digital 4 PCS



DIGITAL	Art.	Dimensions
	2972	150 mm x 0.01 mm / 6" x 0.0005"
	2975	0-25 mm x 0.01 mm
		150 mm x 19 mm
	2978	100 mm x 70 mm / 90°

Art.
2980

Stahl-Winkelmesser

matt verchromt, mit Feststellschraube, zum Messen der Winkelgrade von 0-180°

Rapporteur d'angles en acier

chromé mat, avec vis de blocage, pour mesurer les angles de 0 à 180°

Goniometro in acciaio

cromato satinato, con vite di fermo, per la misurazione di angoli 0-180°

Art.	L mm	mm
2977	200	1 - 0-180°

inox

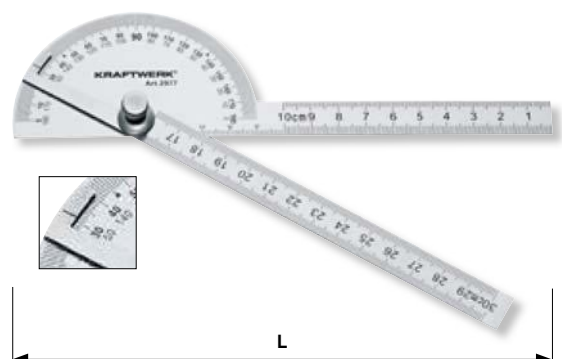

Elektronische Taschen-Digital-Wasserwaage mit 2 Libellen

Misst Winkel elektronisch und zeigt sie digital in Grad oder Prozent an. Messbereich 0° bis 90° bei ± 0,1° Genauigkeit, Messwertanzeige in 0,1-Grad-Schritten oder %-Schritten. Sekundenschnelle Kalibrierung an Ort und Stelle sowie HOLD-Funktion. Schlagfestes ABS-Polymer-Gehäuse mit magnetischer Aluminium-Grundplatte.

Niveau digital électronique de poche à 2 fioles.

Mesure électronique des angles et affichage digital en degrés et en pourcentage. Capacité 0° à 90° avec ± 0,1° de précision, lecture en pas de 0,1 degrés ou pourcentage.

Calibrage rapide, dispose d'une fonction HOLD.

En ABS-polymère résistant aux chocs avec plateau magnétique en aluminium.

Mini livella digitale tascabile con 2 livelle a bolla

Misurazione elettronica degli angoli con precisa indicazione sul display in 0,1 gradi o in passi percentuali. Campo d'azione da 0° a 90°, grande precisione ± 0,1, taratura in pochi secondi, funzione HOLD, costruzione in ABS, resistente agli urti, con base magnetico d'appoggio in alluminio.

Art.

2939

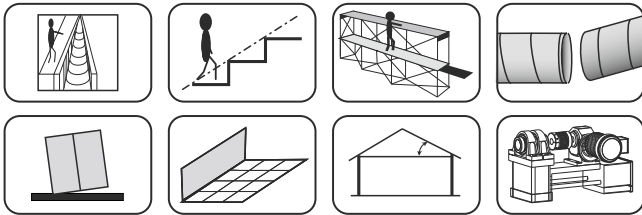

Torpedo-Wasserwaage

mit Magnet an der Unterseite und 3 Libellen

Niveau à bulle torpedo

avec base magnétique et 3 fioles

Livella torpedo

con base magnetica e 3 livelle a bolla

Art.

L
mm

3970

225

Fühlerlehren-Satz

Lehrenblätter metrisch aus gehärtetem Federstahl, konische Blattform, mit Feststellschraube.

Jeu de jauges d'épaisseur

lames métriques flexibles en acier trempé de forme conique, avec vis de blocage.

Assortimento di spessimetri

lame metriche in acciaio di molla temprato e di forma conica, con vite di fermo.

Art.

L
mm

👁
mm

2974

107

0.05-0.1-0.15-0.2-0.3-
0.4-0.5-0.6-0.7-0.8



↕ 107 x 55 x 18 mm

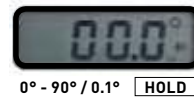

← L →

10
PCS



← L →

Zimmermanns-Bleistift
Crayon de charpentier
Matita da falegname



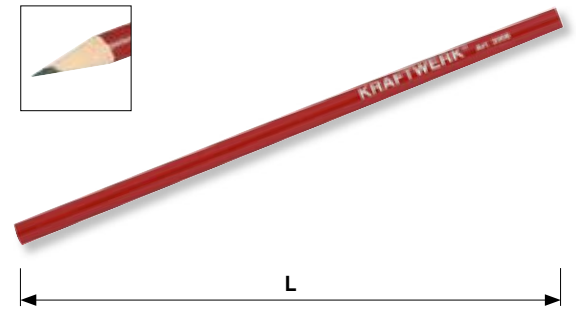





Art.	L mm	
3966	175	144

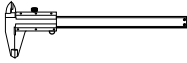

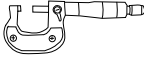
Messwerkzeugkoffer
Coffret d'outils de mesure
Valigetta di utensili di misura di precisione

9
PCS

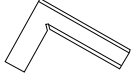
COMPLETO

-  Art. 2970 150 mm x 0.05 mm / 6" x 1/128"
-  Art. 4701-0519 5 m x 19 mm
-  Art. 2975 0-25 mm x 0.01 mm
-  Art. 3196 L 130-630 mm, 2000 g
-  Art. 4998 145 mm
-  Art. 2976 300 mm x 28 mm
-  Art. 2977 200 mm
-  Art. 2978 100 mm x 70 mm
-  Art. 2974 0.05-0.1-0.15-0.2-0.3-0.4-0.5-0.6-0.7-0.8 mm



 421 x 200 x 68 mm

Art.
4900-12K

Vergößerungsglas mit LED-Licht

- 3-fache Vergrößerung
- Sehr helles LED mit intelligenter Steuerung für lange Lebensdauer der Batterie
- Nicht deformierende, qualitativ hochstehende Glaslupe
- Ergonomischer 2-Komponenten-Griff
- Rahmen aus gummiartigem TPE für zusätzlichen Schutz

Loupe grossissante avec lampe LED

- *Grossissement 3 x*
- *LED à forte intensité lumineuse avec commande automatique pour une plus longue durée de vie des piles*
- *Verre optique non déformant de haute qualité*
- *Poignée ergonomique bi-matière*
- *Monture avec revêtement TPE pour protection renforcée*

Lente d'ingrandimento con luce LED

- Ingrandimento per 3 volte
- LED ad alta luminosità con sistema IC integrato che permette di aumentare al massimo la durata della batteria
- Vetro ottico non deformabile di alta qualità
- Impugnatura ergonomica bimatériale antiscivolo
- Montatura con rivestimento in TPE per una migliore protezione contro gli urti

Art.

3341



ERGOKRAFT



Taschenlupe mit LED-Beleuchtung

3 Vergrößerungen 3-5-7 x

Loupe de poche avec éclairage LED

3 grossissements 3-5-7 x

Lente d'ingrandimento tascabile con luce LED

3 incrementi 3-5-7-x



Art.

3342





Spiralbohrer

rollgewalzt, zylindrisch, kurz, rechtsschneidend, leistungsstark, hohe Rundlaufgenauigkeit, gute Spanabfuhr

Foret hélicoïdal

laminé, cylindrique, court, coupe à droite, performant, grande concentricité, bonne évacuation des copeaux

Punta elicoidal

laminato, cilindrico, corto, taglio a destra, efficiente, alta concentricità, buona evacuazione del truciolo

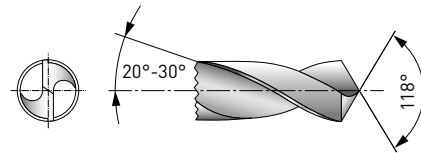

10
PCS

10 Stk./pcs./pz.

Art. 10010 - Art. 10080



5
PCS

5 Stk./pcs./pz.

Art. 10085 - Art. 10130



HSS

DIN 338 N / ISO 235

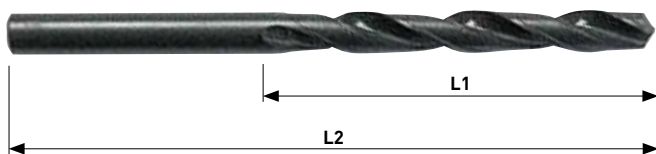

Art.	Ø mm	L1 mm	L2 mm
10010	1.0	12	34
10015	1.5	18	40
10020	2.0	24	49
10025	2.5	30	57
10030	3.0	33	61
10032	3.2	36	65
10033	3.3	36	65
10035	3.5	39	70
10040	4.0	43	75
10042	4.2	43	75
10045	4.5	47	80

Art.	Ø mm	L1 mm	L2 mm
10048	4.8	53	86
10050	5.0	52	86
10055	5.5	57	93
10060	6.0	57	93
10065	6.5	63	101
10068	6.8	69	109
10070	7.0	69	109
10075	7.5	69	109
10080	8.0	75	117
10085	8.5	75	117
10090	9.0	81	125

Art.	Ø mm	L1 mm	L2 mm
10095	9.5	81	125
10100	10.0	87	133
10102	10.2	87	133
10105	10.5	87	133
10110	11.0	94	142
10115	11.5	94	142
10120	12.0	101	151
10125	12.5	101	151
10130	13.0	101	151

Spiralbohrer-Kassette

rollgewalzt, zylindrisch, kurz, rechtsschneidend, leistungsstark, hohe Rundlaufgenauigkeit, gute Spanabfuhr

Jeu de forets hélicoïdaux

laminés, cylindriques, courts, coupe à droite, performants, grande concentricité, bonne évacuation des copeaux

Assortimento di punte

rullate, cilindriche, corte, taglio a destra, efficiente, alta concentricità, buona evacuazione del truciolo

Art.	Ø mm
10903	2.0-2.5-3.0-3.5-4.0-4.5-5.0 5.5-6.0-6.5-7.0-7.5-8.0

13
PCS

HSS

DIN 338 N / ISO 235



Spiralbohrer-Kassette

rollgewalzt, zylindrisch, kurz, rechtsschneidend, leistungsstark, hohe Rundlaufgenauigkeit, gute Spanabfuhr

Jeu de forets hélicoïdaux

laminés, cylindriques, courts, coupe à droite, performants, grande concentricité, bonne évacuation des copeaux

Assortimento di punte

rullate, cilindriche, corte, taglio a destra, efficiente, alta concentricità, buona evacuazione del truciolo

Art.	Ø mm
10900	1.0-1.5-2.0-2.5-3.0-3.5-4.0-4.5-5.0-5.5 6.0-6.5-7.0-7.5-8.0-8.5-9.0-9.5-10.0

19
PCS

HSS

DIN 338 N / ISO 235



Spiralbohrer-Kassette

rollgewalzt, zylindrisch, kurz, rechtsschneidend, leistungsstark, hohe Rundlaufgenauigkeit, gute Spanabfuhr

Jeu de forets hélicoïdaux

laminés, cylindriques, courts, coupe à droite, performants, grande concentricité, bonne évacuation des copeaux

Assortimento di punte

rullate, cilindriche, corte, taglio a destra, efficiente, alta concentricità, buona evacuazione del truciolo

Art.	Ø mm
10906	1.0-1.5-2.0-2.5-3.0-3.5-4.0-4.5-5.0-5.5-6.0-6.5-7.0 7.5-8.0-8.5-9.0-9.5-10.0-10.5-11.0-11.5-12.0-12.5-13.0

25
PCS

HSS

DIN 338 N / ISO 235



Spiralbohrer-Magazin

rollgewalzt, zylindrisch, kurz, rechtsschneidend, leistungsstark, hohe Rundlaufgenauigkeit, gute Spanabfuhr

Coffret de forets hélicoïdaux

laminés, cylindriques, courts, coupe à droite, performants, grande concentricité, bonne évacuation des copeaux

Valigetta di punte

rullate, cilindriche, corte, taglio a destra, efficiente, alta concentricità, buona evacuazione del truciolo



HSS

DIN 338 N / ISO 235



Art.	Pcs.	Ø mm
	10	1.0-1.5-2.0-2.5-3.0-3.5-4.0-4.5
10910	10	5.0-5.5-6.0-6.5-7.0-7.5-8.0
	5	8.5-9.0-9.5-10.0

Spiralbohrer-Magazin, leer

Coffret vide pour forets

Valigetta metallica vuota per punte



Art.
10910K

Spiralbohrer

geschliffen, zylindrisch, kurz, rechtsschneidend, Kreuzanschliff ab \varnothing 3 mm, leistungsstark, hohe Rundlaufgenauigkeit, gute Spanabfuhr

Foret hélicoïdal

affûté, cylindrique, court, coupe à droite, affûtage en croix à partir de \varnothing 3 mm, performant, grande concentricité, bonne évacuation des copeaux

Punta elicoidale

rettificata, cilindrico, corto, taglio a destra, afilatura in croce da \varnothing 3 mm, efficiente, alta concentricità, buona evacuazione del truciolo

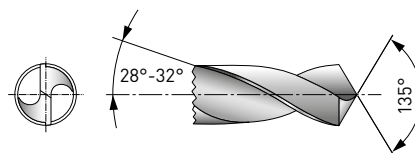

geschliffen / rectifiés / retificate

HSS-G

DIN 338 N / ISO 235

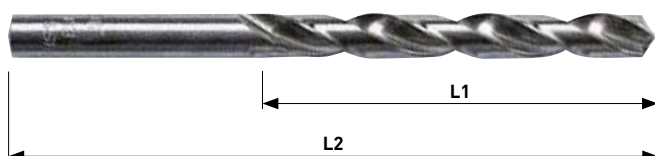

10
PCS

10 Stk./pcs./pz.

Art. 11010 - Art. 11080



5
PCS

5 Stk./pcs./pz.

Art. 11081 - Art. 11130



Art.	\varnothing mm	L1 mm	L2 mm
11010	1.0	12	34
11011	1.1	14	36
11012	1.2	16	38
11013	1.3	16	38
11014	1.4	18	40
11015	1.5	18	40
11016	1.6	20	43
11017	1.7	20	43
11018	1.8	22	46
11019	1.9	22	46
11020	2.0	24	49
11021	2.1	24	49
11022	2.2	27	53
11023	2.3	27	53
11024	2.4	30	57
11025	2.5	30	57
11026	2.6	30	57
11027	2.7	33	61
11028	2.8	33	61
11029	2.9	33	61
11030	3.0	33	61
11031	3.1	36	65
11032	3.2	33	65
11033	3.3	33	65
11034	3.4	39	70
11035	3.5	39	70
11036	3.6	39	70
11037	3.7	39	70
11038	3.8	43	75
11039	3.9	43	75
11040	4.0	43	75
11041	4.1	43	75
11042	4.2	43	75

Art.	\varnothing mm	L1 mm	L2 mm
11043	4.3	47	80
11044	4.4	47	80
11045	4.5	47	80
11046	4.6	47	80
11047	4.7	47	80
11048	4.8	52	86
11049	4.9	52	86
11050	5.0	52	86
11051	5.1	52	86
11052	5.2	52	86
11053	5.3	52	86
11054	5.4	57	93
11055	5.5	57	93
11056	5.6	57	93
11057	5.7	57	93
11058	5.8	57	93
11059	5.9	57	93
11060	6.0	57	93
11061	6.1	63	101
11062	6.2	63	101
11063	6.3	63	101
11064	6.4	63	101
11065	6.5	63	101
11066	6.6	63	101
11067	6.7	63	101
11068	6.8	69	109
11069	6.9	69	109
11070	7.0	69	109
11071	7.1	69	109
11072	7.2	69	109
11073	7.3	69	109
11074	7.4	69	109
11075	7.5	69	109

Art.	\varnothing mm	L1 mm	L2 mm
11076	7.6	75	117
11077	7.7	75	117
11078	7.8	75	117
11079	7.9	75	117
11080	8.0	75	117
11081	8.1	75	117
11082	8.2	75	117
11083	8.3	75	117
11084	8.4	75	117
11085	8.5	75	117
11086	8.6	81	125
11087	8.7	81	125
11088	8.8	81	125
11089	8.9	81	125
11090	9.0	81	125
11091	9.1	81	125
11092	9.2	81	125
11093	9.3	81	125
11094	9.4	81	125
11095	9.5	81	125
11096	9.6	81	125
11097	9.7	87	133
11098	9.8	87	133
11099	9.9	87	133
11100	10.0	87	133
11102	10.2	87	133
11105	10.5	87	133
11110	11.0	94	142
11115	11.5	94	142
11120	12.0	101	151
11125	12.5	101	151
11130	13.0	101	151

Spiralbohrer-Kassette

geschliffen, zylindrisch, kurz, rechtsschneidend, Kreuzanschliff ab Ø 3 mm, leistungsstark, hohe Rundlaufgenauigkeit, gute Spanabfuhr

Jeu de forets hélicoïdaux

affûtés, cylindriques, courts, coupe à droite, affûtage en croix à partir de Ø 3 mm, performants, grande concentricité, bonne évacuation des copeaux

Assortimento di punte elicoidale

rettificate, cilindrico, corto, taglio a destra, afilatura in croce da Ø 3 mm, efficiente, alta concentricità, buona evacuazione del truciolo

Art.	Ø mm
11904	1.0-1.5-2.0-2.5-3.0-3.5-4.0-4.5-5.0-5.5 6.0-6.5-7.0-7.5-8.0-8.5-9.0-9.5-10.0

Spiralbohrer-Kassette

geschliffen, zylindrisch, kurz, rechtsschneidend, Kreuzanschliff ab Ø 3 mm, leistungsstark, hohe Rundlaufgenauigkeit, gute Spanabfuhr

Jeu de forets hélicoïdaux

affûtés, cylindriques, courts, coupe à droite, affûtage en croix à partir de Ø 3 mm, performants, grande concentricité, bonne évacuation des copeaux

Assortimento di punte elicoidale

rettificate, cilindrico, corto, taglio a destra, afilatura in croce da Ø 3 mm, efficiente, alta concentricità, buona evacuazione del truciolo

Art.	Ø mm
11905	1.0-1.5-2.0-2.5-3.0-3.5-4.0-4.5-5.0-5.5-6.0-6.5-7.0 7.5-8.0-8.5-9.0-9.5-10.0-10.5-11.0-11.5-12.0-12.5-13.0

Spiralbohrer-Magazin

geschliffen, zylindrisch, kurz, rechtsschneidend, Kreuzanschliff ab Ø 3 mm, leistungsstark, hohe Rundlaufgenauigkeit, gute Spanabfuhr

Coffret de forets hélicoïdaux

affûtés, cylindriques, courts, coupe à droite, affûtage en croix à partir de Ø 3 mm, performants, grande concentricité, bonne évacuation des copeaux

Valigetta di punte elicoidale

rettificate, cilindrico, corto, taglio a destra, afilatura in croce da Ø 3 mm, efficiente, alta concentricità, buona evacuazione del truciolo

Art.	Pcs.	Ø mm
11910	10	1.0-1.5-2.0-2.5-3.0-3.5-4.0-4.5
	10	5.0-5.5-6.0-6.5-7.0-7.5-8.0
	5	8.5-9.0-9.5-10.0

19
PCS

HSS-G

DIN 338 N / ISO 235



geschliffen / rectifiés / retificate

25
PCS

HSS-G

DIN 338 N / ISO 235



geschliffen / rectifiés / retificate

170
PCS

HSS-G

DIN 338 N / ISO 235



geschliffen / rectifiés / retificate

Spiralbohrer

kobaltlegiert, geschliffen, zylindrisch, kurz, rechtsschneidend, Kreuzanschliff ab \varnothing 3 mm, leistungsstark, hohe Rundlaufgenauigkeit, gute Spanabfuhr

Foret hélicoïdal

alliage cobalt, affûté, cylindrique, court, coupe à droite, affûtage en croix à partir de \varnothing 3 mm, performant, grande concentricité, bonne évacuation des copeaux

Punta elicoidal

al cobalto, rettificata, cilindrico, corto, taglio a destra, afilatura in croce da \varnothing 3 mm, efficiente, alta concentricità, buona evacuazione del truciolo

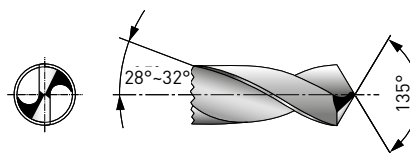

geschliffen / rectifiés / retificate

HSS-E Co 5

DIN 338 N / ISO 235

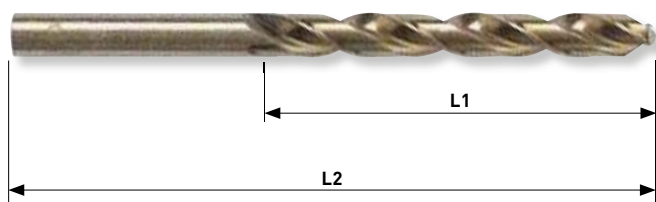

10
PCS

10 Stk./pcs./pz.

Art. 13010 - Art. 13080



5
PCS

5 Stk./pcs./pz.

Art. 13085 - Art. 13130



Art.	\varnothing mm	L1 mm	L2 mm
13010	1.0	12	34
13015	1.5	18	40
13020	2.0	24	49
13025	2.5	30	57
13030	3.0	33	61
13032	3.2	36	65
13033	3.3	36	65
13035	3.5	39	70
13040	4.0	43	75
13042	4.2	43	75
13045	4.5	47	80

Art.	\varnothing mm	L1 mm	L2 mm
13048	4.8	53	86
13050	5.0	52	86
13055	5.5	57	93
13060	6.0	57	93
13065	6.5	63	101
13068	6.8	69	109
13070	7.0	69	109
13075	7.5	69	109
13080	8.0	75	117
13085	8.5	75	117
13090	9.0	81	125

Art.	\varnothing mm	L1 mm	L2 mm
13095	9.5	81	125
13100	10.0	87	133
13102	10.2	87	133
13105	10.5	87	133
13110	11.0	94	142
13115	11.5	94	142
13120	12.0	101	151
13125	12.5	101	151
13130	13.0	101	151

Spiralbohrer-Kassette

kobaltlegiert, geschliffen, zylindrisch, kurz, rechtsschneidend, Kreuzanschliff ab Ø 3 mm, leistungsstark, hohe Rundlaufgenauigkeit, gute Spanabfuhr

Jeu de forets hélicoïdaux

alliage cobalt, affûtés, cylindriques, courts, coupe à droite, affûtage en croix à partir de Ø 3 mm, performants, grande concentricité, bonne évacuation des copeaux

Assortimento di punte elicoidale

al cobalto, rettificate, cilindriche, corte, taglio a destra, afilatura in croce da Ø 3 mm, efficiente, alta concentricità, buona evacuazione del truciolo

Art.	Ø mm
13904	1.0-1.5-2.0-2.5-3.0-3.5-4.0-4.5-5.0-5.5 6.0-6.5-7.0-7.5-8.0-8.5-9.0-9.5-10.0

Spiralbohrer-Kassette

kobaltlegiert, geschliffen, zylindrisch, kurz, rechtsschneidend, Kreuzanschliff ab Ø 3 mm, leistungsstark, hohe Rundlaufgenauigkeit, gute Spanabfuhr

Jeu de forets hélicoïdaux

alliage cobalt, affûtés, cylindriques, courts, coupe à droite, affûtage en croix à partir de Ø 3 mm, performants, grande concentricité, bonne évacuation des copeaux

Assortimento di punte elicoidale

al cobalto, rettificate, cilindriche, corte, taglio a destra, afilatura in croce da Ø 3 mm, efficiente, alta concentricità, buona evacuazione del truciolo

Art.	Ø mm
13905	1.0-1.5-2.0-2.5-3.0-3.5-4.0-4.5-5.0-5.5-6.0-6.5-7.0 7.5-8.0-8.5-9.0-9.5-10.0-10.5-11.0-11.5-12.0-12.5-13.0

Spiralbohrer-Magazin

kobaltlegiert, geschliffen, zylindrisch, kurz, rechtsschneidend, Kreuzanschliff ab Ø 3 mm, leistungsstark, hohe Rundlaufgenauigkeit, gute Spanabfuhr

Coffret de forets hélicoïdaux

alliage cobalt, affûtés, cylindriques, courts, coupe à droite, affûtage en croix à partir de Ø 3 mm, performants, grande concentricité, bonne évacuation des copeaux

Valigetta di punte elicoidale

al cobalto, rettificate, cilindriche, corte, taglio a destra, afilatura in croce da Ø 3 mm, efficiente, alta concentricità, buona evacuazione del truciolo

Art.	Pcs.	Ø mm
13910	10	1.0-1.5-2.0-2.5-3.0-3.5-4.0-4.5
	10	5.0-5.5-6.0-6.5-7.0-7.5-8.0
	5	8.5-9.0-9.5-10.0

19
PCS

HSS-E Co 5

DIN 338 N / ISO 235



geschliffen / rectifiés / retificate

25
PCS

HSS-E Co 5

DIN 338 N / ISO 235



geschliffen / rectifiés / retificate

170
PCS

HSS-E Co 5

DIN 338 N / ISO 235



geschliffen / rectifiés / retificate

Kernloch-Spiralbohrer

geschliffen, zylindrisch, kurz, rechtsschneidend, Kreuzanschliff ab \varnothing 3 mm, leistungsstark, hohe Rundlaufgenauigkeit, gute Spanabfuhr

Foret hélicoïdal pour avant-trou

affûté, cylindrique, court, coupe à droite, affûtage en croix à partir de \varnothing 3 mm, performant, grande concentricité, bonne évacuation des copeaux

Punta elicoidale per preforo

rettificata, cilindrico, corto, taglio a destra, afilatura in croce da \varnothing 3 mm, efficiente, alta concentricità, buona evacuazione del truciolo

Art.	\varnothing mm	L1 mm	L2 mm	PCS.
15016	1.6 (M2)	20	43	3
15020.5	2.05 (M2.5)	24	49	3
15025	2.5 (M3)	30	57	3
15033	3.3 (M4)	36	65	3
15042	4.2 (M5)	43	75	2
15050	5.0 (M6)	52	86	2
15068	6.8 (M8)	69	109	1
15085	8.5 (M10)	75	117	1
15102	10.2 (M12)	87	133	1

HSS-G

DIN 338 N / ISO 235

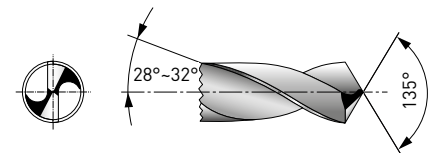
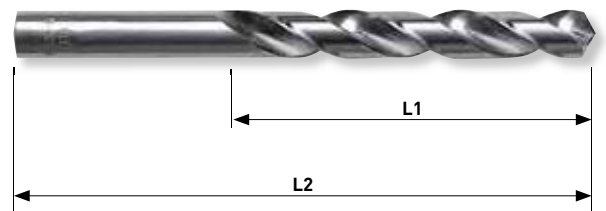

geschliffen / rectifiés / retificate

Handgewindebohrer-Satz

aus dem Vollen geschliffen, dreiteiliger Satz mit Vor-, Mittel- und Fertigschneider, hohe Schnittleistung

Jeu de tarauds à main

taillés et rectifiés, jeu de 3 pièces avec ébaucheur intermédiaire et finisseur, haute performance de coupe

Set maschi a mano

rettificate di uno pezzo, serie di 3 pezzi con sbozzatore, intermedio e finitore, alta prestazione di taglio

Art.	\varnothing mm	mm	L mm	PCS.
21030	M3 (2.5)	0.5	44	3
21040	M4 (3.3)	0.7	47	3
21050	M5 (4.2)	0.8	53	3
21060	M6 (5.0)	1	55	3
21080	M8 (6.8)	1.25	56	3
21100	M10 (8.5)	1.5	69	3
21120	M12 (10.2)	1.75	75	3

HSS-G

DIN 352 / ISO 2857

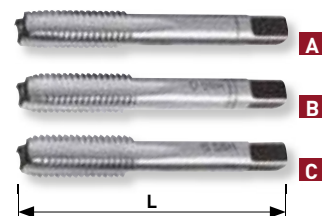

A Vorschneider
Ebaucheur
Sbozzatore

B Mittelschneider
Intermédiaire
Intermedio

C Fertigschneider
Finisseur
Finitore

Einschnittgewindebohrer für Maschinen- und Handgebrauch



kurz, aus dem Vollen geschliffen, hohe Schnittleistung

Taraud main et machine

court, taillé à la meule et rectifié, haute performance de coupe

Maschio a mano ed a macchina

corto, retificate di uno pezzo, alta prestazione di taglio

Art.	 Ø mm	 mm	L mm	PCS.
22020	M2 (1.6)	0.4	38	1
22025	M2.5 (2.05)	0.45	43	1
22030	M3 (2.5)	0.5	44	1
22040	M4 (3.3)	0.7	47	1
22050	M5 (4.2)	0.8	53	1
22060	M6 (5.0)	1	55	1
22080	M8 (6.8)	1.25	56	1
22100	M10 (8.5)	1.5	69	1
22120	M12 (10.2)	1.75	75	1

Einschnittgewindebohrer für Gewindeeinsätze



kurz, aus dem Vollen geschliffen, hohe Schnittleistung

Taraud pour douilles de réparation

court, taillé à la meule et rectifié, haute performance de coupe

Maschio per il ripristino del filetto

corto, retificate di uno pezzo, alta prestazione di taglio

Art.	 Ø mm	 mm	L1 mm	L2 mm	PCS.
4900-51T05	M5 (5.2)	0.8	21	61	1
4900-51T06	M6 (6.3)	1	24	69	1
4900-51T08	M8 (8.4)	1.25	28	78	1
4900-51T10	M10 (10.5)	1.5	33	89	1
4900-51T12	M12 (12.5)	1.75	32	88	1
4900-51T14	M14 (14.5)	2	40	100	1

HSS-G

DIN 352 / ISO 2857

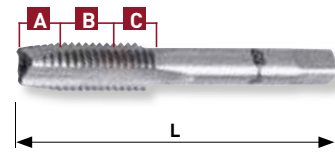

- A** Vorschneider
Ebaucheur
Sbozzatore
- B** Mittelschneider
Intermédiaire
Intermedio
- C** Fertigschneider
Finisseur
Finitore

HSS

DIN 371

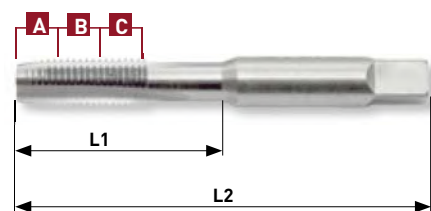

- A** Vorschneider
Ebaucheur
Sbozzatore
- B** Mittelschneider
Intermédiaire
Intermedio
- C** Fertigschneider
Finisseur
Finitore

Maschinengewindebohrer



lang, aus dem Vollen geschliffen, hohe Schnittleistung

Taraud machine

court, taillé à la meule et rectifié, haute performance de coupe

Maschio macchina

lungo, retificate di uno pezzo, alta prestazione di taglio

Art.	 \emptyset mm	 mm	L1 mm	L2 mm	PCS.
25030	M3 (2.5)	0.5	21	61	1
25040	M4 (3.3)	0.7	24	69	1
25050	M5 (4.2)	0.8	28	78	1
25060	M6 (5.0)	1	33	89	1
25080	M8 (6.8)	1.25	32	88	1
25100	M10 (8.5)	1.5	40	100	1
25120	M12 (10.2)	1.75	80	110	1

HSS-G

DIN 371

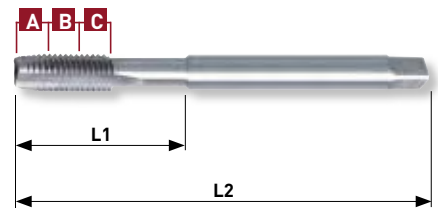

- A** Vorschneider **B** Mittelschneider **C** Fertigschneider
Ebaucheur *Intermédiaire* *Finisseur*
 Sbozzatore Intermedio Finitore

Verstellbares Windeisen

Tourne-à-gauche ajustable

Giramaschi regolabile

DIN 1814

Art.	No.	\emptyset	L mm
24015	1-1/2	M2 - M12	175

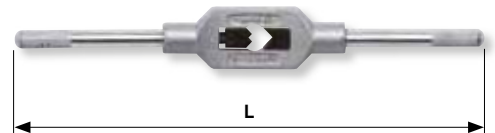

Verstellbares Windeisen

Tourne-à-gauche ajustable

Giramaschi regolabile

DIN 1814

Art.	No.	\emptyset	L mm
4900-51A412	2	M4 - M12	280
4900-51A620	3	M6 - M20	375

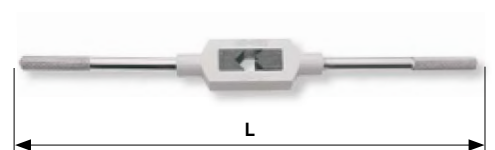

Werkzeughalter mit Knarre
Porte-taraud à cliquet
Giramaschi a cricchetto

Art.	No.	Ø	L1 mm	L2 mm
24110	1	M3 - M10	100	86

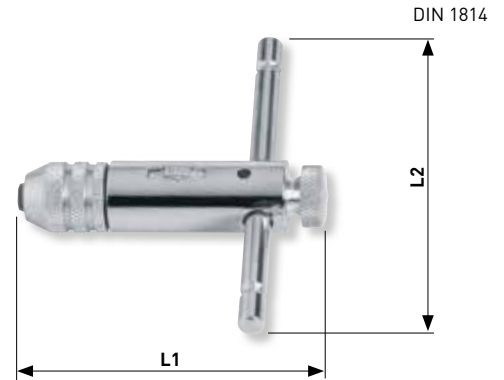

Schneideisen

rund, hohe Schnittleistung

Filière

ronde, haute performance de coupe

Filiera

rotonda, alta prestazione di taglio

Art.	Ø	$\frac{1}{8}$ mm	D mm
26030	M3	0.5	25
26040	M4	0.7	25
26050	M5	0.8	25
26060	M6	1	25
26080	M8	1.25	25
26100	M10	1.5	25
26120	M12	1.75	25

HSS-G

DIN / ISO 261



Schneideisenhalter

Porte-filière

Portafiliera

Art.	No.	Ø	L mm
24010	3	M3 - M12	215

DIN 225

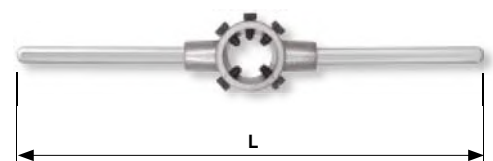

Schneideisen mit Halter

hohe Schnittleistung

Filière avec porte-filière

haute performance de coupe

Filiera con impugnatura

alta prestazione di taglio

Art.	Ø	 mm	D mm
23020	M2	0.4	179
23025	M2.5	0.45	179
23030	M3	0.5	179
23040	M4	0.7	179
23050	M5	0.8	179
23060	M6	1	221
23080	M8	1.25	221
23100	M10	1.5	221
23120	M12	1.75	221

HSS-G

ERGOKRAFT



Gewindeschablone

Jauge de filetage

Contafiletti

Art.	 mm
24200	0.25-0.30-0.35-0.40-0.45-0.50-0.60-0.70 0.75-0.80-0.90-1.00-1.25-1.50-1.75-2.00 2.50-3.00-3.50-4.00-4.50-5.00-5.50-6.00

24
PCS



Gewindeschablone

Jauge de filetage

Contafiletti

Art.	 mm
4900-51A1240	0.25-0.30-0.35-0.40-0.45-0.50-0.60-0.70 0.75-0.80-0.90-1.00-1.25-1.50-1.75-2.00

16
PCS



Bohrer- und Einschnitt-Gewindeschneid-Werkzeugsatz

geschliffen

Jeu de forets, tarauds main et machine et filières rectifiés



Assortimento di punte, maschi a mano ed a machina e filiere



rettificati

24
PCS

HSS-G

Art.	Ø
3240MOD	M3 - M12

	Art. 26030	M3		Art. 11025	2.5 mm
	Art. 26040	M4		Art. 11033	3.3 mm
	Art. 26050	M5		Art. 11042	4.2 mm
	Art. 26060	M6		Art. 11050	5.0 mm
	Art. 26080	M8		Art. 11068	6.8 mm
	Art. 26100	M10		Art. 11085	8.5 mm
	Art. 26120	M12		Art. 11102	10.2 mm

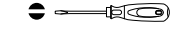
	Art. 24010	No. 3 M3-M12		Art. 22030	M3
	Art. 24015	No. 1-1/2 M2-M12		Art. 22040	M4
				Art. 22050	M5
				Art. 22060	M6
				Art. 22080	M8
				Art. 22100	M10
				Art. 22120	M12



↕ 270 x 150 x 55 mm

Bohrer- und Handgewindeschneid-Werkzeugkoffer

geschliffen

Coffret de forets, tarauds main et filières rectifiés



Valigetta di punte, maschi a mano e filiere



rettificati



56
PCS

HSS-G

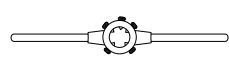
Art.	Ø
3245MOD	M3 - M12

	Art. 26030	M3		Art. 11033	3.3 mm
	Art. 26040	M4		Art. 11042	4.2 mm
	Art. 26050	M5		Art. 11068	6.8 mm
	Art. 26060	M6		Art. 11102	10.2 mm
	Art. 26080	M8			
	Art. 26100	M10			
	Art. 26120	M12			

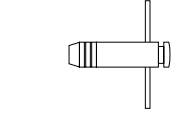
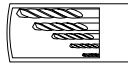
	Art. 24010	No. 3 M3-M12		Art. 21030	M3
	Art. 24015	No. 1-1/2 M2-M12		Art. 21040	M4
				Art. 21050	M5
				Art. 21060	M6
				Art. 21080	M8
				Art. 21100	M10
				Art. 21120	M12

	Art. 24110	No. 1 M3-M10		Art. 11904	1-10 / 0.5 mm
				Art. 24200	0.25-6.0 mm



↕ 410 x 275 x 70 mm

Bohrer- und Handgewindeschneid-Werkzeugkoffer ground

**Coffret de forets, tarauds à main et filières
rectifiés**









**Valigetta di punte, maschi a mano e filiere
rettificati**

42
PCS

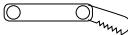
HSS-G

COMPLETO

Art.	Ø
4900-59K	M3 - M12

 Ø 25 mm	Art. 26030	M3		Art. 11033	3.3 mm
	Art. 26040	M4		Art. 11042	4.2 mm
	Art. 26050	M5		Art. 11068	6.8 mm
	Art. 26060	M6		Art. 11102	10.2 mm
	Art. 26080	M8			
	Art. 26100	M10			
	Art. 24200	0.25-6.0 mm / 60°		Art. 25030	M3
	Art. 25040	M4		Art. 25050	M5
	Art. 24010	M3-M12		Art. 25060	M6
	Art. 24015	M2-M12		Art. 25080	M8
	Art. 24110	M3-M10		Art. 25100	M10
	Art. 25120	M12		Art. 11904	1-10 / 0.5 mm
	Art. 3240S	0.5 mm			



402 x 173 x 48 mm

Bohrer- und Einschnitt-Gewindeschneid- Werkzeugsatz

geschliffen, mit Schneideisen mit Halter

**Jeu de forets, tarauds main et machine et filières
rectifiés, avec filières avec porte-filrière**

**Valigetta di punte, maschi a mano ed
a machina e filiere**









rettificati, con filiere con impugnatura

40
PCS

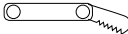
HSS-G

COMPLETO

Art.	Ø
4900-34K	M3 - M12

	Art. 23030	M3		Art. 11033	3.3 mm
	Art. 23040	M4		Art. 11042	4.2 mm
	Art. 23050	M5		Art. 11068	6.8 mm
	Art. 23060	M6		Art. 11102	10.2 mm
	Art. 23080	M8			
	Art. 23100	M10			
	Art. 24200	0.25-6.0 mm		Art. 25030	M3
	Art. 25040	M4		Art. 25050	M5
	Art. 24015	No. 1-1/2 M2-M12		Art. 25060	M6
	Art. 25080	M8		Art. 25100	M10
	Art. 24110	No. 1 M3-M10		Art. 25120	M12
	Art. 11904	1-10 / 0.5 mm			



421 x 200 x 68 mm

Gewinde-Einsätze

Filets rapportés

Filetti riportati

Art.	Ø	Pcs.
28050	M5 x 0.8	12
28060	M6 x 1.0	12
28080	M8 x 1.25	12
28100	M10 x 1.25	12
28120	M12 x 1.75	6
28140	M14 x 1.25	6



Zapfenbrecher

Rupteur de tiges

Troncature

Art.	Ø
4900-51P05	M5
4900-51P06	M6
4900-51P08	M8
4900-51P10	M10
4900-51P12	M12
4900-51P14	M14



Gewindedorn

Outil de pose

A posa

Art.	Ø
4900-51S05	M5
4900-51S06	M6
4900-51S08	M8
4900-51S10	M10
4900-51S12	M12
4900-51S14	M14



Teleskop-Magnetsucher
Doigt magnétique télescopique
Penna telescopica magnetica

Art.
4900-51M



Gewinde-Einsatz-Ratsche
Cliquet pour filets rapportés
Cricchetto per filetti riportati

Art.
4900-51R



Gewindereparatur-Koffer
 mit Gewinde-Einsätzen
Coffret pour la réparation de filetages
 avec filets rapportés
Kit per la riparazione delle filettature
 corredato con i filetti riportati

Art.
4900-51K

77
PCS

COMPLETO



M4-M12, M6-M20
 3/18"-1/2", 1/4"-3/4"



M5x0.8, M6x1.0,
 M8x1.25, M10x1.5,
 M12x1.75, M14x1.25

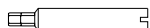

M5x0.8, M6x1.0,
 M8x1.25, M10x1.5,
 M12x1.75, M14x1.25



HSS-G

M5x0.8, M6x1.0,
 M8x1.25, M10x1.5,
 M12x1.75, M14x1.25



215-640 mm

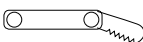

0.5-1.75 mm



1/4"



16 M5-0.8
 12 M6-1.0
 10 M8-1.25
 6 M10-1.5
 5 M12-1.75
 4 M14-1.25

Mehrstufenbohrer

mit geschliffener Spiralnute und Kantenbrecher, sehr gute Schnittleistung

Foret étagé à chambrer

avec cannelure rectifiée spiralee et briseur angulaire, très haute performance de coupe

Fresa conica a gradini

con scanalatura rettificata a spirale e edge breaker, molto alla prestazione di taglio

Art.	min-max Ø mm	t1 mm	t2 mm	D1 mm	L1 mm	L2 mm
18010	4-5-6-7-8-9-10-11-12	7	4.5	6	20	65
18020	4-6-8-10 12-14-16-18-20	8	5.5	8	20	75
18030	4-6-8-10-12-14-16 18-20-22-24-26-28-30	8	5	10	22	100

Mehrstufenbohrer-Satz

mit geschliffener Spiralnute und Kantenbrecher, sehr gute Schnittleistung

Jeu de forets étagés à chambrer

avec cannelure rectifiée spiralee et briseur angulaire, très haute performance de coupe

Assortimento di frese coniche a gradini

con scanalatura rettificata a spirale e edge breaker, molto alla prestazione di taglio

Art. 18010 4-12 mm
Art. 18020 4-20 mm
Art. 18030 4-30 mm

Art.	min-max Ø mm
18000	4 - 12 / 4 - 20 / 4 - 30

Bleeschälbohrer

geschliffen, konische Form, sehr gute Schnittleistung

Foret conique à chanfreiner

rectifié, forme conique, très haute performance de coupe

Fresa conica

rettificata, forma conica, molto alla prestazione di taglio

Art.	min-max Ø mm		D1 mm	L1 mm	L2 mm
18110	3 - 14	10°	6	20	58
18120	5 - 20	10°	8	20	71
18130	16 - 30.5	12°	9	22	77

HSS-E Co 5%

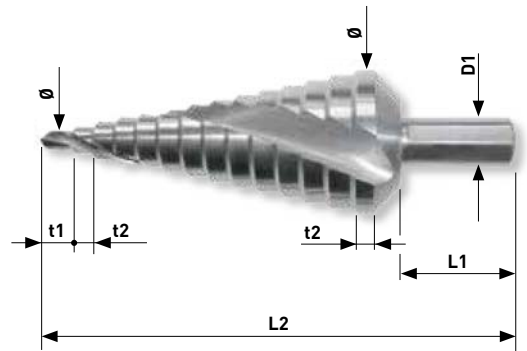

3
PCS

HSS-E Co 5%



HSS-E Co 5%

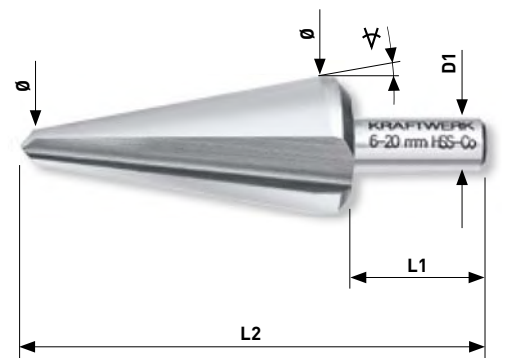

Blechsälbohrer-Satz

geschliffen, konische Form, sehr gute Schnittleistung

Jeu de forets conique à chanfreiner

rectifiés, forme conique, très haute performance de coupe

Assortimento di frese coniche

rettificata, forma conica, molto alla prestazione di taglio

Art. 18110 3-14 mm
Art. 18120 5-20 mm
Art. 18130 16-30.5 mm

Art.	min-max Ø mm
18100	3 - 14 / 5 - 20 / 16 - 30.5

Kegelsenker

90°, dreischneidig geschliffen

Fraise à chanfreiner

90°, 3 dents rectifiées

Fresa a sbavare ed incassare

90°, 3 tagli rettificati

Art.	Ø mm	D1 mm	D2 mm	L mm
18210	6.3	1.5	5	45
18220	8.3	2	6	50
18230	10.4	2.5	6	50
18240	12.4	2.8	8	56
18250	16.5	3.2	10	60
18260	20.5	3.5	10	63

Kegelsenker-Satz

90°, dreischneidig geschliffen

Jeu de fraises à chanfreiner

90°, 3 dents rectifiées

Assortimento di frese a sbavare ed incassare

90°, 3 tagli rettificati

Art. 18210 6.3 mm
Art. 18220 8.3 mm
Art. 18230 10.4 mm
Art. 18240 12.4 mm
Art. 18250 16.5 mm
Art. 18260 20.5 mm

Art.	Ø mm
18200	6.3 - 8.3 - 10.4 - 12.4 - 16.5 - 20.5

3
PCS

HSS-E Co 5%



HSS-E Co 5%

DIN 335 C

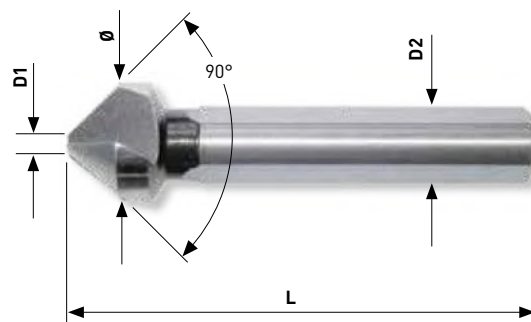

6
PCS

HSS-E Co 5%

DIN 335 C



Flachsenker
Fraise à lamer
Fresa dritta

Art.	∅ mm	D1 mm	D2 mm	L mm
18310	3.4 (M3)	6	5	71
18320	4.5 (M4)	8	5	71
18330	5.5 (M5)	10	8	80
18340	6.6 (M6)	11	8	80
18350	9 (M8)	15	12.5	100
18360	11 (M10)	18	12.5	100

Flachsenker-Satz
Jeu de fraises à lamer
Assortimento di frese dritte

Art. 18310 3.4 mm / M3
Art. 18320 4.5 mm / M4
Art. 18330 5.5 mm / M5
Art. 18340 6.6 mm / M6
Art. 18350 9.0 mm / M8
Art. 18360 11.0 mm / M10

Art.	∅ mm
18300	3.4-4.5-5.5-6.6-9.0-11.0

Lochsäge
Scie trépan
Sega a tazza

Art.	∅ mm		L mm
19190	19	Art. 19001	50
19200	20	Art. 19001	48
19220	22	Art. 19001	48
19250	25	Art. 19001	48
19290	29	Art. 19001	48
19320	32	Art. 19002	50
19350	35	Art. 19002	48
19380	38	Art. 19002	44
19440	44	Art. 19002	43
19510	51	Art. 19002	43
19570	57	Art. 19002	43
19650	65	Art. 19002	43
19680	68	Art. 19002	43
19760	76	Art. 19002	43

HSS-E Co 5%

DIN 373



6
PCS

HSS-E Co 5%

DIN 335 C



HSS-E Co 8% Bi-Metall

DIN 335 C

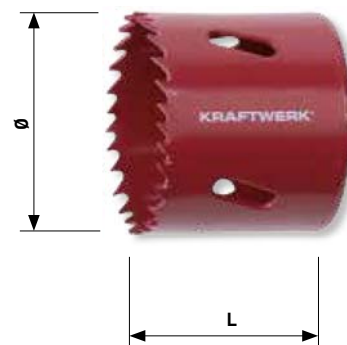

Aufnahmeschaft mit Zentrierbohrer
Arbre de montage avec mèche centre
Albero per seghe a tazza con punta

Art.	∅	inch	L1 mm	L2 mm	∅ mm
19001	M14	3/8"	50	95	14 - 30

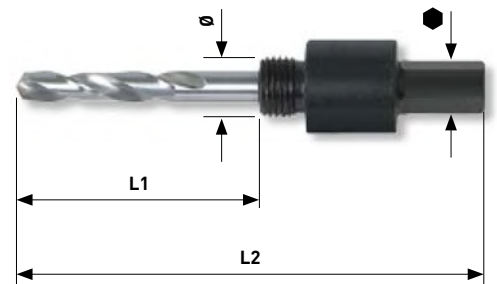

Aufnahmeschaft SDS-Plus mit Zentrierbohrer
Arbre de montage SDS-Plus avec mèche centre
Albero per seghe a tazza SDS-Plus con punta

Art.	∅	SDS-plus	L1 mm	L2 mm	∅ mm
19005	M14	SDS-Plus	46	126	14 - 30

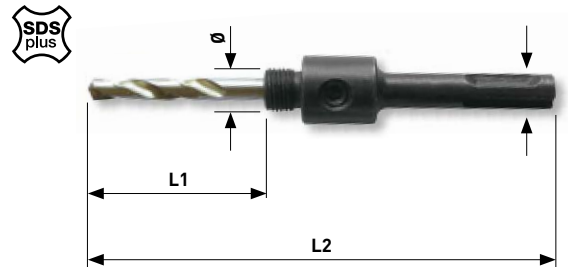

Aufnahmeschaft mit Zentrierbohrer
Arbre de montage avec mèche centre
Albero per seghe a tazza con punta

Art.	∅	inch	L1 mm	L2 mm	∅ mm
19002	M14	7/16"	50	118	32 - 76

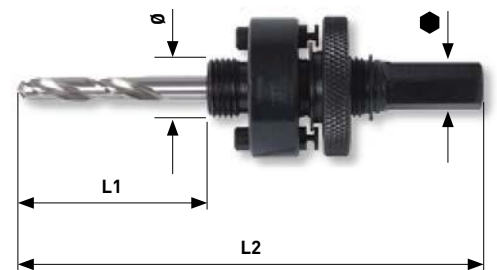

Aufnahmeschaft SDS-Plus mit Zentrierbohrer
Arbre de montage SDS-Plus avec mèche centre
Albero per seghe a tazza SDS-Plus con punta

Art.	∅	SDS-plus	L1 mm	L2 mm	∅ mm
19006	M14	SDS-Plus	46	146	32 - 76

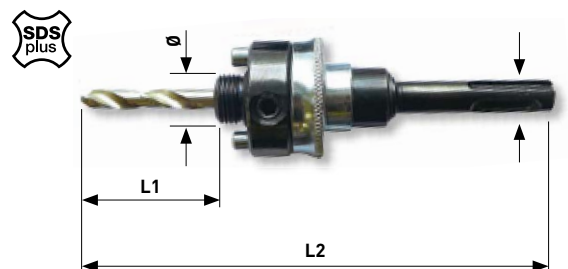

Zentrierbohrer
Mèche centre
Punta guida per albero seghe a tazza

Art.	∅ inch / mm	L mm
19004	1/4" / 6,35 mm	75

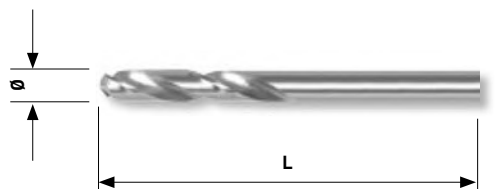

Verlängerung für Lochsägen
Rallonge pour scies trépan
Prolunga per seghe a tazza

Art.	inch	mm	L mm
19003	3/8"	3/8"	300

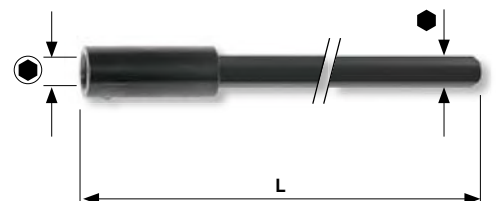

Lochsägen-Koffer
Coffret de scies trépan
Valigetta di seghe a tazza

HSS
bimetal
M42+8%Co

COMPLETO

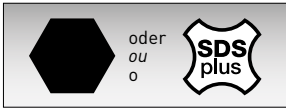

HSS-E Co 8% Bi-Metall M42

Art.		
4900-39K		✓
4900-39KS		

16
PCS

15
PCS

	Art. 19001	Art. 19005	14-30 mm / 3/8"
	Art. 19002	Art. 19006	32-76 mm / 7/16"
	Art. 19003		300 mm / 3/8"

	Art. 19190	19 mm
	Art. 19200	20 mm
	Art. 19220	22 mm
	Art. 19250	25 mm
	Art. 19290	29 mm
	Art. 19320	32 mm
	Art. 19350	35 mm
	Art. 19380	38 mm
	Art. 19440	44 mm
	Art. 19510	51 mm
	Art. 19570	57 mm
	Art. 19680	68 mm
	Art. 19760	76 mm

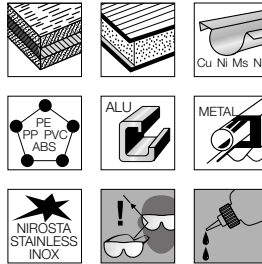

↕ 402 × 173 × 48 mm



Art. 4900-39K



Art. 4900-39B

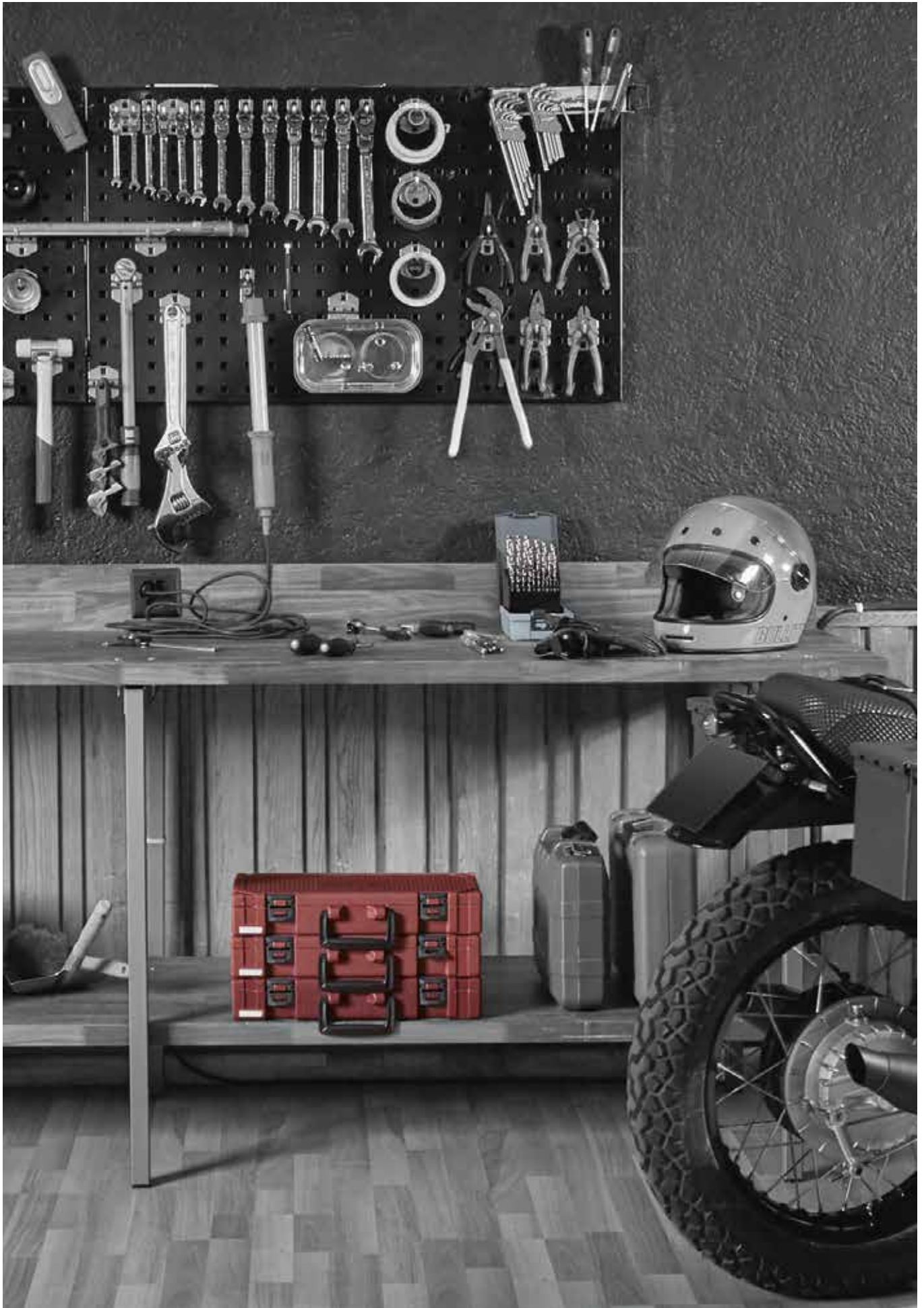

INDEX / INDEX / INDICE

Art. No.	Cat.	Art. No.	Cat.	Art. No.	Cat.	Art. No.	Cat.
1350-2	394	2053	123	2301	388	2586	255
1350-3	394	2056	122	2302	388	2589-01	253
1350-4	394	2057	123	2303	388	2589-02	253
1350-5	394	2138	273	2304	388	2589-0607	252
1350-6	394	2139	273	2305	388	2589-0809	252
1350-8	394	2187	271	2308	388	2589-1011	252
1927	16	2211	357	2310	388	2589-1213	252
2000	160	2212	356	2315	388	2589-1415	252
2000E	160	2212-A2	354	2319	389	2589-1617	252
2003	108	2213-A21	355	2320	393	2589-1819	252
2004	111	2214-J2	355	2323	393	2589-2022	252
2010	160	2215-J21	356	2336	392	2589-2123	252
2010E	160	2216-180	348	2336NY	392	2589-2427	252
2013	113	2216-200	348	2336PU	392	2589-2528	252
2020	160	2217-250	349	2339	391	2589-3032	252
2020E	160	2217-280	349	2340	391	2589-5810	253
2023	115	2223	360	2342	391	2590-0809	250
2025	116	2223-01	360	2345	391	2590-1011	250
2026	116	2223-2.4	360	2351	391	2590-1213	250
2032	120	2223-3.2	360	2352	391	2590-1415	250
2033	118	2223-4.0	360	2354	390	2590-1617	250
2034	119	2223-4.8	360	2355	390	2590-1819	250
2035	319	2224	360	2366	391	2590-3814	251
2035A12	306	2225	366	2368	392	2591-16	251
2035B38	305	2230	376	2376	390	2591-21	251
2035F06	304	2231	346	2378	390	2592-08	252
2035F08	304	2232	346	2380	390	2592-09	252
2035F10	304	2233	347	2381	390	2592-10	252
2035F12	304	2234	344	2383	390	2592-11	252
2035PH1	305	2235	345	2385	388	2592-12	252
2035PH2	305	2236	344	2387	388	2592-13	252
2035PH3	305	2237	345	2390	389	2592-14	252
2035PH4	305	2238	347	2392	389	2592-15	252
2035S	319	2240	380	2395	389	2592-16	252
2035T30	305	2241	381	2404	243	2592-17	252
2035T40	305	2242	381	2406	243	2592-18	252
2035T45	305	2243	382	2408	243	2592-19	252
2035T50	305	2244	382	2410	243	2593-02	287
2036	320	2245	382	2412	243	2593-03	287
2037	173	2246	382	2415	243	2593-04	287
2038.1	173	2251	381	2418	243	2593-05	287
2038.2	173	2252-225	358	2585-12	251	2593-06	287
2039	309	2253-200	358	2585-34	251	2593-07	287
2045	170	2254-275	359	2585-1719	251	2593-08	287
2045E	170	2262-07	365	2585-1721	251	2593-10	287

Art. No.	Cat.	Art. No.	Cat.	Art. No.	Cat.	Art. No.	Cat.
2593-025	287	2598-14	249	2673-5	294	2726-5	291
2594-10	289	2598-15	249	2674-5	294	2730-5	292
2594-15	289	2598-16	249	2676-5	293	2731-5	292
2594-20	289	2598-17	249	2677-5	293	2731-10	292
2594-25	289	2598-18	249	2678-5	293	2732-5	292
2594-27	289	2598-19	249	2679-5	293	2732-10	292
2594-30	289	2598-20	249	2680-5	293	2732-50	292
2594-40	289	2598-21	249	2681-5	293	2733-5	292
2594-45	289	2598-22	249	2683-5	293	2733-10	292
2594-50	289	2598-23	249	2684-5	293	2733-50	292
2597-06	248	2598-24	249	2685-5	293	2734-5	292
2597-07	248	2598-25	249	2686-5	293	2734-10	292
2597-08	248	2598-26	249	2687-5	293	2734-50	292
2597-09	248	2598-27	249	2688-5	293	2735-5	292
2597-10	248	2598-28	249	2689-5	294	2735-10	292
2597-11	248	2598-29	249	2690-5	299	2735-50	292
2597-12	248	2598-30	249	2694	306	2736-5	292
2597-13	248	2598-32	249	2696-5	294	2736-10	292
2597-14	248	2598-34	249	2697-5	299	2736-50	292
2597-15	248	2598-99	250	2700	309	2737-5	292
2597-16	248	2599-01	254	2701-5	291	2737-10	292
2597-17	248	2599-02	255	2701-10	291	2738-5	292
2597-18	248	2599-0607	254	2701-50	291	2739-5	292
2597-19	248	2599-0809	254	2702-5	291	2741-5	293
2597-20	248	2599-1011	254	2702-10	291	2741-10	293
2597-21	248	2599-1012	253	2702-50	291	2742-5	293
2597-22	248	2599-1213	254	2703-5	291	2742-10	293
2597-23	248	2599-1415	254	2703-10	291	2743-5	293
2597-24	248	2599-1617	254	2704-5	291	2743-10	293
2597-25	248	2599-1819	254	2705-5	291	2744-5	293
2597-26	248	2599-2022	254	2711-5	291	2744-10	293
2597-27	248	2599-2123	254	2711-10	291	2745-5	293
2597-28	248	2599-2427	254	2711-50	291	2746-5	293
2597-29	248	2599-2528	254	2712-5	291	2749-5	292
2597-30	248	2599-3032	254	2712-10	291	2750	306
2597-32	248	2599-3457	253	2712-50	291	2750-1	306
2597-99	250	2661-5	294	2713-5	291	2751-5	292
2598-06	249	2662-5	294	2713-10	291	2752-5	292
2598-07	249	2663-5	294	2713-50	291	2753-5	292
2598-08	249	2665-5	294	2714-5	291	2754-5	292
2598-09	249	2667-5	294	2721-5	291	2755-5	292
2598-10	249	2668-5	294	2722-5	291	2756-5	292
2598-11	249	2669-5	294	2723-5	291	2757-5	292
2598-12	249	2671-5	294	2724-5	291	2758	310
2598-13	249	2672-5	294	2725-5	291	2760	184, 305

INDEX / INDEX / INDICE

Art. No.	Cat.	Art. No.	Cat.	Art. No.	Cat.	Art. No.	Cat.
2761	192, 306	2844-5	298	2995	143	3090	158
2764	306	2845-5	298	2998	143	3091	158
2765	307	2846-5	298	3005	107	3092	158
2765-1	307	2850-5	299	3006	161	3093	158
2768	308	2860-5	299	3035	114	3094	158
2770-5	294	2861	298	3036	142	3094B	158
2778	317	2862	298	3057	322	3095	158
2780	310	2863	298	3057-02	321	3095B	158
2783	311	2864	298	3057-03	321	3096	158
2786	311	2865	298	3057-04	321	3096B	158
2790	311	2866	298	3057-05	321	3097	159
2801-5	297	2867	298	3057-06	321	3098	159
2801-10	297	2904	12	3057-07	321	3099	159
2802-5	297	2904-4909	34	3057-08	321	3132-1	272
2802-10	297	2904-4911	35	3057-10	321	3132-2	272
2802-25	297	2904-4931	73	3057-12	321	3132-3	272
2803-5	297	2905	11	3057-14	321	3132-4	272
2804-5	297	2905-4909	34	3057-16	321	3133-15	272
2811-5	297	2905-4911	35	3058	323	3133-20	272
2811-10	297	2905-4931	73	3058-10	323	3135-0	272
2812-5	297	2907	12	3058-11	323	3135-1	272
2812-10	297	2907-4909	34	3058-12	323	3135-2	272
2812-25	297	2907-4911	35	3058-13	323	3137-0	272
2813-5	297	2907-4917	91	3058-14	323	3137-1	272
2814-5	297	2907-4931	73	3058-15	323	3137-2	272
2821-5	297	2939	407	3058-16	323	3157	273
2822-5	297	2950	16	3058-17	323	3177	277
2823-5	297	2951	16	3058-19	323	3177-00	276
2824-5	297	2961	397	3059	321	3177-0	276
2825-5	297	2961E	397	3059-1	321	3177-1	276
2826-5	297	2962	397	3059-2	321	3177-15	276
2831-5	298	2962E	397	3059-3	321	3177-20	276
2832-5	298	2963	397	3059-4	321	3177-24	276
2832-10	298	2963E	397	3059-5	321	3177-30	276
2833-5	298	2964	397	3059-6	321	3177-35	276
2833-10	298	2964E	397	3060	322	3177-40	276
2834-5	298	2970	405	3060-06	322	3178	277
2834-10	298	2972	405	3060-08	322	3178-0	276
2835-5	298	2974	407	3060-10	322	3178-1	276
2835-10	298	2975	406	3060-12	322	3178-05	276
2836-5	298	2976	404	3083	126	3178-06	276
2837-5	298	2977	406	3084	127	3178-07	276
2841-5	298	2978	404	3086	127	3178-08	276
2842-5	298	2980	406	3087	128	3178-09	277
2843-5	298	2990B	131	3089	128	3178-10	277

Art. No.	Cat.	Art. No.	Cat.	Art. No.	Cat.	Art. No.	Cat.
3178-15	277	3235-G27	168	3282-160V	341	3331-032	398
3178-20	277	3235-G30	168	3283-180	333	3331-050	398
3180	278	3235GK1	168	3284-160	334	3331-063	398
3181	278	3235GK2	168	3285-160	336	3331-075	398
3182	278	3235H	167	3285-200	336	3331-100	398
3188	325	3235K1	166	3285-200V	342	3331-125	398
3190	326	3235K2	166	3286-200	336	3332-032	399
3195	326	3235K3	167	3287-160	337	3332-075	399
3196	326	3235-R13	169	3288-160	338	3333-032	399
3197	325	3235-R14	169	3289-160	339	3333-075	399
3198	326	3235-R15	169	3289-160V	343	3335	398
3200	160	3235-R17	169	3290-175	351	3336	399
3200E	160	3235-R19	169	3290-230	367	3338	380
3201B	161	3235-R22	169	3290-250	351	3338E	380
3201F	161	3235-R24	169	3290-300	351	3341	409
3204	160	3235-R27	169	3291	368	3342	409
3206	162	3235-R30	169	3291-220	368	3350	394
3206E	162	3235RK1	169	3292	339	3350-2	393
3208	163	3235RK2	169	3292-150	358	3350-3	393
3210	160	3235-U12P	170	3292-175	358	3350-4	393
3210E	160	3235-U12R	170	3292-250	358	3350-5	393
3214	160	3236	165	3301	372	3350-6	393
3216	162	3236GK1	168	3302	372	3350-8	393
3216E	162	3236GK2	168	3303	372	3355	395
3218	163	3236H	167	3303H	373	3355-2	394
3220	160	3236K1	166	3304	372	3355-3	394
3220E	160	3236K2	166	3305	383	3355-4	394
3226	162	3236K3	167	3308-1	383	3355-5	394
3226E	162	3236RK1	169	3309	383	3355-6	394
3228	163	3236RK2	169	3310	373	3358-1	395
3231	165	3237	165	3311	373	3358-2	395
3232	165	3237E	166	3312	374	3359	397
3232E	166	3240MOD	424	3313	374	3359E	397
3233	165	3245MOD	424	3314	375	3365-12	395
3233-34E	166	3254	367	3315	374	3365-18	395
3234	165	3266-180	351	3316-18	383	3368-5	396
3235	165	3266-250	351	3316-24	383	3368-7	396
3235-36E	166	3266-300	351	3316-32	383	3370	396
3235-G13	168	3266SET	351	3317	373	3374	396
3235-G14	168	3281-160	331	3318	374	3380-18	395
3235-G15	168	3281-180	331	3319	383	3380-22	395
3235-G17	168	3281-180V	340	3322	375	3400-50	224
3235-G19	168	3281-200	331	3323	375	3400-54	224
3235-G22	168	3282-140	332	3324	376	3401-08	221
3235-G24	168	3282-160	332	3325	376	3401-09	221

INDEX / INDEX / INDICE

Art. No.	Cat.	Art. No.	Cat.	Art. No.	Cat.	Art. No.	Cat.
3401-10	221	3403-19	233	3418	223	3489	245
3401-11	221	3403-20	233	3419	223	3491	245
3401-12	221	3403-21	233	3420	223	3492	245
3401-13	221	3403-22	233	3421	223	3493	245
3401-14	221	3403-24	233	3422	223	3494	245
3401-15	221	3403-51	234	3424	223	3497	245
3401-16	221	3403-54	234	3427	224	3497R	245
3401-17	221	3404-4x2	233	3427M	223	3498	246
3401-18	221	3404-08	230	3430	225	3498R	246
3401-19	221	3404-09	230	3430M	223	3503-56	240
3401-20	221	3404-10	230	3431	225	3505	237
3401-21	221	3404-11	230	3432	225	3506	237
3401-22	221	3404-12	230	3432M	223	3507	237
3401-24	221	3404-13	230	3433	225	3508	237
3401-50	221	3404-14	230	3434	225	3509	237
3401-54	222	3404-15	230	3434M	223	3510	237
3402-08	235	3404-16	230	3435	225	3511	237
3402-09	235	3404-17	230	3436	225	3512	237
3402-10	235	3404-18	230	3436M	223	3513	237
3402-11	235	3404-19	230	3437	225	3514	237
3402-12	235	3404-20	230	3438	225	3515	237
3402-13	235	3404-21	230	3440	229	3516	237
3402-14	235	3404-22	230	3441	229	3517	237
3402-15	235	3404-24	230	3441M	223	3518	237
3402-16	235	3404-50	231	3442	229	3519	237
3402-17	235	3404-51	231	3443	229	3520	237
3402-18	235	3404-54	231	3444	229	3521	237
3402-19	235	3404-0813	232	3445	229	3522	237
3403-08	233	3404-1019	232	3446	229	3523	237
3403-08S	235	3404-1619	232	3446M	223	3524	237
3403-09	233	3404-51612	232	3447	229	3525	237
3403-10	233	3404-91634	232	3450M	223	3526	237
3403-10S	235	3405	223	3471	229	3527	237
3403-11	233	3406	223	3472	229	3528	237
3403-11S	235	3407	223	3473	229	3530	237
3403-12	233	3408	223	3474	229	3532	237
3403-12S	235	3409	223	3480	245	3534	237
3403-13	233	3410	223	3481	245	3536	237
3403-13S	235	3411	223	3482	245	3538	237
3403-14	233	3412	223	3483	245	3541	237
3403-14S	235	3413	223	3484	245	3545	247
3403-15	233	3414	223	3485	245	3546	246
3403-16	233	3415	223	3486	245	3546M	237
3403-17	233	3416	223	3487	245	3547	246
3403-18	233	3417	223	3488	245	3548	246

Art. No.	Cat.	Art. No.	Cat.	Art. No.	Cat.	Art. No.	Cat.
3549	246	3589	240	3604-2.5	281	3609-15	286
3550	238	3590	240	3604-3	281	3609-20	286
3550M	237	3591	240	3604-4	281	3609-25	286
3551	242	3592	240	3604-5	281	3609-27	286
3552	242	3593	240	3604-6	281	3609-30	286
3553	239	3594	240	3604-7	281	3609-40	286
3553R	239	3595	240	3604-8	281	3609-45	286
3554	239	3596	240	3604-10	281	3609-50	286
3554R	239	3597	240	3605	283	3609S	286
3556	238	3598	240	3605-10	283	3623	290
3557	238	3599	240	3605-15	283	3624	290
3557R	238	3601	279	3605-20	283	3625	288
3558	239	3601-1.5	279	3605-25	283	3626	288
3558R	239	3601-2	279	3605-27	283	3627	288
3560	242	3601-2.5	279	3605-30	283	3634	274
3561	242	3601-3	279	3605-40	283	3636-2	274
3562	242	3601-4	279	3605-45	283	3636-2.5	274
3563	242	3601-5	279	3605-50	283	3636-3	274
3564	242	3601-6	279	3606	282	3636-4	274
3565	242	3601-8	279	3606-12	281	3636-5	274
3566	242	3601-10	279	3606-14	281	3636-6	274
3567	242	3602	280	3606-17	281	3636-7	274
3568	242	3602-1.5	280	3606-19	281	3636-8	274
3569	242	3602-2	280	3607	284	3636-10	274
3570	242	3602-2.5	280	3607-10	284	3636-12	274
3570R	242	3602-3	280	3607-15	284	3637-10	275
3577	244	3602-4	280	3607-20	284	3637-15	275
3579	242	3602-5	280	3607-25	284	3637-20	275
3580	247	3602-6	280	3607-27	284	3637-25	275
3580-00	247	3602-7	280	3607-30	284	3637-27	275
3580-01	247	3602-8	280	3607-40	284	3637-30	275
3580-02	247	3602-10	280	3607-45	284	3637-40	275
3580-03	247	3603	283	3607-50	284	3637-45	275
3580-04	247	3603-1/4	282	3608	285	3637-50	275
3580-05	247	3603-1/8	282	3608-10	285	3637-55	275
3580-06	247	3603-1/16	282	3608-15	285	3641	279
3582	244	3603-3/8	282	3608-20	285	3642	281
3583	242	3603-3/16	282	3608-25	285	3645	287
3584-U14	255	3603-3/32	282	3608-27	285	3691	236
3584-U38	255	3603-5/16	282	3608-30	285	3692	236
3585	241	3603-5/32	282	3608-40	285	3693	236
3585R	241	3603-5/64	282	3608-45	285	3750	307
3586	242	3604	282	3608-50	285	3760	307
3587	240	3604-1.5	281	3609	286	3764	307
3588	240	3604-2	281	3609-10	286	3764-1	307

INDEX / INDEX / INDICE

Art. No.	Cat.	Art. No.	Cat.	Art. No.	Cat.	Art. No.	Cat.
3766	308	3919	13	3958-30	147	3995.1	132
3767	308	3920	13	3959	146	3996ET	131
3768	308	3921	14	3959-30	147	4000	161
3769	308	3922	14	3962	33	4001	162
3776	313	3923	14, 31	3964-01	27	4001E	162
3777	315	3924	14	3964-02	24	4002	124
3782-1	312	3925	15, 31	3964-02-07	24	4003	110
3784-07	299	3927	15	3964-03	25	4004	109
3784-08	299	3929	17, 32	3964-04	25	4004R1	164
3784-10	299	3930	17	3964-05	25	4004R2	164
3784-13	299	3934	10	3964-06	28	4004RS	163
3784-M6	299	3934-99	10	3964-07	28	4007	106
3784-M8	299	3934-4909	34	3964-08	29	4009	160
3784-M10	299	3934-4911	35	3964-09	29	4009E	160
3784-M12	299	3934-4917	91	3964-10	28	4010	161
3786	314	3934-4931	73	3964-11	26	4011	162
3787	315	3935	11	3964-12	24	4011E	162
3788	313	3935-99	11	3964-12-01	24	4012	125
3789	313	3936	9	3964-13	26	4013	113
3792	319	3936-4920	38	3964-14	25	4015	140
3794	316	3936-4920F	38	3964-15	26	4015.1	140
3795	316	3936ES	15	3964-16	26	4017	112
3796	314	3944	135	3964-16-99	29	4019	160
3799	309	3944.1	135	3964-17	27	4019E	160
3905	9	3944.2	135	3964-18	29	4020	161
3905-4909	34	3946	136	3964-19	27	4021	162
3905-4911	35	3946.1	136	3964-20	30	4021E	162
3905-4931	73	3946.2	136	3964-21	30	4022	125
3907-1	8	3948	137	3964-22	30	4027	115
3907-4909	34	3948.1	137	3964-23	30	4029	160
3907-4911	35	3948.2	137	3964-24	28	4029E	160
3907-4917	91	3949	138	3964-25	27	4033	107
3907-4931	73	3949.1	138	3964A	19	4037	117
3908	8	3949.2	138	3964AIX	19	4045	114
3908-4909	34	3950	144	3964B	20	4047	130
3908-4911	35	3952	144	3964BIX	20	4055	134
3908-4917	91	3953	144	3964D	21	4070	310
3908-4931	73	3954	144	3964DIX	21	4072	318
3912	102	3955	145	3964E	22	4081-12	172
3912-99	103	3955-30	147	3964EIX	22	4081-14	172
3912A	102	3956	145	3964F	23	4081-34	172
3917	10	3956-30	147	3964FIX	23	4081-38	172
3917-4919	98	3957	145	3966	408	4081-341	172
3917-4919+3	98	3957-30	147	3970	407	4110-1	259
3918	13	3958	146	3995	132	4110-2	259

Art. No.	Cat.	Art. No.	Cat.	Art. No.	Cat.	Art. No.	Cat.
4110-3	259	4140-5	259	4234-115	346	4261-2	361
4110-4	259	4140-6	259	4235-115	344	4261-3	361
4110-5	259	4145-1	260	4241-230	349	4261-4	361
4110-6	259	4145-2	260	4241-260	349	4261-5	361
4112-2	259	4149	320	4241-300	349	4262	362
4115-0	260	4150-1	261	4242-180	348	4262-1	362
4115-1	260	4150-2	261	4242-210	348	4262-2	362
4115-2	260	4160	263	4242-250	348	4262-3	362
4115-3	260	4161	263	4248-220	359	4262-4	362
4117-2	260	4162	262	4248-250	359	4262-5	362
4120-0	261	4163	263	4249-220	359	4262-7	362
4120-1	261	4164	268	4251-175	357	4262-8	362
4120-2	261	4165	264	4252-A0	354	4262-9	362
4120-3	261	4166	264	4252-A1	354	4263	363
4125-08	261	4168	265	4252-A2	354	4263-1	363
4125-10	261	4170	267	4252-A3	354	4263-2	363
4125-15	261	4201-200P	331	4252-A4	354	4263-3	363
4125-20	261	4205-200P	335	4253-A01	354	4263-4	363
4125-25	261	4210-160	343	4253-A11	354	4263-5	363
4125-27	261	4210-210	343	4253-A21	354	4263-6	363
4125-30	261	4211-180	340	4253-A31	354	4263-7	363
4125-40	261	4212-160	340	4253-A41	354	4263-8	363
4126-08	262	4212-180	340	4254-J0	355	4264	364
4126-10	262	4213-180	341	4254-J1	355	4264-1	364
4126-15	262	4213-200	341	4254-J2	355	4264-2	364
4126-20	262	4214-200	334	4254-J3	355	4264-3	364
4126-25	262	4215-205	341	4254-J4	355	4264-4	364
4126-27	262	4216-205	342	4255-J01	356	4264-5	364
4126-30	262	4219-160	342	4255-J11	356	4271-165	331
4126-40	262	4220-250	343	4255-J21	356	4271-180	331
4127-06	268	4222-180	350	4255-J31	356	4271-205	331
4127-07	268	4222-250	350	4255-J41	356	4272-145	332
4127-08	268	4222-300	350	4256-240	357	4272-160	332
4127-10	268	4223-180	349	4260-18	365	4272-180	332
4127-11	268	4223-240	349	4260-18E	365	4272-190	332
4127-12	268	4223-300	349	4260-24	365	4273-180	333
4127-13	268	4223-400	349	4260-24E	365	4273-200	333
4127-055	268	4224	350	4260-30	365	4274-200	333
4128	270	4224-250	350	4260-30E	365	4275-170	335
4130	270	4224-320	350	4260-36	365	4275-205	335
4132	271	4224-400	350	4260-36E	365	4276-205	336
4133B	308	4225-250	352	4260-42	365	4277-160	337
4135	267	4231-115	347	4260-42E	365	4278-160	338
4140-3	259	4232-115	348	4261	361	4279-160	338
4140-4	259	4233-115	345	4261-1	361	4279-180	339

INDEX / INDEX / INDICE

Art. No.	Cat.	Art. No.	Cat.	Art. No.	Cat.	Art. No.	Cat.
4286	356	4405-18	228	4900-27B	51	4900-51P14	426
4320	385	4405-19	228	4900-28B	46	4900-51R	427
4320-1	384	4701-0206	402	4900-28K	228	4900-51S05	426
4320-2	384	4701-0316	402	4900-29B	40	4900-51S06	426
4320-3	384	4701-0519	402	4900-30B	45	4900-51S08	426
4320-4	384	4706-0313	403	4900-30K	241	4900-51S10	426
4320-5	384	4706-0319	402	4900-31B	54	4900-51S12	426
4321	385	4706-0527	402	4900-31K	269	4900-51S14	426
4322	325	4706-0827	402	4900-33B	61	4900-51T05	420
4322-1	323	4711-3013	404	4900-34B	66	4900-51T06	420
4322-2	324	4712-109.5	403	4900-34K	425	4900-51T08	420
4322-3	324	4716-1013	403	4900-35B	55	4900-51T10	420
4322-4	324	4900-01B	39	4900-35K	289	4900-51T12	420
4322-5	324	4900-01K	108	4900-36B	56	4900-51T14	420
4322-6	324	4900-02B	39	4900-36K	290	4900-54B	53
4322-7	325	4900-03B	40	4900-37B	71	4900-54K	266
4325	385	4900-04B	52	4900-38B	41	4900-56B	65
4326	385	4900-04K	265	4900-39B	68	4900-57B1	62
4402-08	226	4900-05B	53	4900-39BS	68	4900-57B2	62
4402-09	226	4900-05K	266	4900-39K	432	4900-57B3	62
4402-11	226	4900-07B	61	4900-39KS	432	4900-58B	41
4402-12	226	4900-08B	63	4900-40B	46	4900-59B	67
4402-14	226	4900-09B	63	4900-40K	222	4900-59K	425
4402-15	226	4900-10B	64	4900-41B	48	4900-60B	52
4402-16	226	4900-11B	65	4900-41K	236	4900-61B	57
4402-17	226	4900-12B	66	4900-42B	60	4900-62B	57
4402-18	226	4900-12K	408	4900-43B	60	4900-63B	58
4402-19	226	4900-13B	44	4900-46B	47	4900-64B	58
4402-20	226	4900-14B	44	4900-46K	234	4900-65B	59
4402-21	226	4900-15B	49	4900-47B	47	4900-66B	65
4402-22	226	4900-15K	246	4900-47K	232	4900-67B	59
4402-24	226	4900-16B	48	4900-48B	50	4900-70B	43
4402-51	227	4900-17B	45	4900-48K	250	4900-71B	43
4402-52	227	4900-17K	225	4900-49B	42	4900-71B1	43
4402-53	227	4900-18B	50	4900-51A412	421	4900-73B	69
4405-08	228	4900-18K	250	4900-51A620	421	4900-74B	70
4405-09	228	4900-19B	56	4900-51A1240	423	4900-75B	70
4405-10	228	4900-20B	42	4900-51B	67	4900E	71
4405-11	228	4900-21B	64	4900-51K	427	4900K	71
4405-12	228	4900-22B	49	4900-51M	427	4902-01	92
4405-13	228	4900-23B	50	4900-51P05	426	4902-02	93
4405-14	228	4900-25B	54	4900-51P06	426	4902-03	93
4405-15	228	4900-25K	274	4900-51P08	426	4902-04	94
4405-16	228	4900-26B	55	4900-51P10	426	4902-05	94
4405-17	228	4900-26K	275	4900-51P12	426	4902-06	95

Art. No.	Cat.	Art. No.	Cat.	Art. No.	Cat.	Art. No.	Cat.
4902-07	95	4920	36	10080	412	11038	415
4902-08	96	4920F	36	10085	412	11039	415
4902-09	97	4931	73	10090	412	11040	415
4902-080	96	5405-250	352	10095	412	11041	415
4902-081	96	5405-290	353	10100	412	11042	415
4902-090	97	5405-350	352	10102	412	11043	415
4902-091	97	5405-450	352	10105	412	11044	415
4903-01	74	5405-600	352	10110	412	11045	415
4903-02	74	5405-900	352	10115	412	11046	415
4903-03	75	5406-320	352	10120	412	11047	415
4903-04	75	5406-420	352	10125	412	11048	415
4903-05	76	5406-540	352	10130	412	11049	415
4903-06	76	5418-300	366	10900	413	11050	415
4903-07	77	5432	377	10903	413	11051	415
4903-08	77	5436	378	10906	413	11052	415
4903-09	81	5440-1	378	10910	414	11053	415
4903-10	81	5440-3	378	10910K	414	11054	415
4903-11	85	5440-5	378	11010	415	11055	415
4903-12	87	5440-5ES	378	11011	415	11056	415
4903-13	88	5441	377	11012	415	11057	415
4903-15	84	5441E	377	11013	415	11058	415
4903-16	78	5451	366	11014	415	11059	415
4903-17	78	5461SET	353	11015	415	11060	415
4903-18	79	5470	380	11016	415	11061	415
4903-19	82	7526	33	11017	415	11062	415
4903-20	82	7527	33	11018	415	11063	415
4903-21	83	10010	412	11019	415	11064	415
4903-22	84	10015	412	11020	415	11065	415
4903-23	87	10020	412	11021	415	11066	415
4903-24	88	10025	412	11022	415	11067	415
4903-25	85	10030	412	11023	415	11068	415
4903-26	86	10032	412	11024	415	11069	415
4903-27	83	10033	412	11025	415	11070	415
4903-28	86	10035	412	11026	415	11071	415
4903-29	79	10040	412	11027	415	11072	415
4903-30	80	10042	412	11028	415	11073	415
4903-31	80	10045	412	11029	415	11074	415
4903-33	89	10048	412	11030	415	11075	415
4903-34	89	10050	412	11031	415	11076	415
4909	34	10055	412	11032	415	11077	415
4911	35	10060	412	11033	415	11078	415
4917	90	10065	412	11034	415	11079	415
4919-01	99	10068	412	11035	415	11080	415
4919-02	100	10070	412	11036	415	11081	415
4919-03	101	10075	412	11037	415	11082	415

INDEX / INDEX / INDICE

Art. No.	Cat.	Art. No.	Cat.	Art. No.	Cat.	Art. No.	Cat.
11083	415	13070	417	18340	430	23080	423
11084	415	13075	417	18350	430	23100	423
11085	415	13080	417	18360	430	23120	423
11086	415	13085	417	19001	431	24010	422
11087	415	13090	417	19002	431	24015	421
11088	415	13095	417	19003	431	24110	422
11089	415	13100	417	19004	431	24200	423
11090	415	13102	417	19005	431	25030	421
11091	415	13105	417	19006	431	25040	421
11092	415	13110	417	19190	430	25050	421
11093	415	13115	417	19200	430	25060	421
11094	415	13120	417	19220	430	25080	421
11095	415	13125	417	19250	430	25100	421
11096	415	13130	417	19290	430	25120	421
11097	415	13904	418	19320	430	26030	422
11098	415	13905	418	19350	430	26040	422
11099	415	13910	418	19380	430	26050	422
11100	415	15016	419	19440	430	26060	422
11102	415	15020.5	419	19510	430	26080	422
11105	415	15025	419	19570	430	26100	422
11110	415	15033	419	19650	430	26120	422
11115	415	15042	419	19680	430	28050	426
11120	415	15050	419	19760	430	28060	426
11125	415	15068	419	21030	419	28080	426
11130	415	15085	419	21040	419	28100	426
11904	416	15102	419	21050	419	28120	426
11905	416	18000	428	21060	419	28140	426
11910	416	18010	428	21080	419	29000	295
13010	417	18020	428	21100	419	29010	295
13015	417	18030	428	21120	419	29020	295
13020	417	18100	429	22020	420	29030	295
13025	417	18110	428	22025	420	29100	295
13030	417	18120	428	22030	420	29110	295
13032	417	18130	428	22040	420	29120	295
13033	417	18200	429	22050	420	29130	295
13035	417	18210	429	22060	420	29240	295
13040	417	18220	429	22080	420	29255	295
13042	417	18230	429	22100	420	29265	295
13045	417	18240	429	22120	420	29270	295
13048	417	18250	429	23020	423	29310	296
13050	417	18260	429	23025	423	29315	296
13055	417	18300	430	23030	423	29320	296
13060	417	18310	430	23040	423	29325	296
13065	417	18320	430	23050	423	29327	296
13068	417	18330	430	23060	423	29330	296

Art. No.	Cat.	Art. No.	Cat.	Art. No.	Cat.	Art. No.	Cat.
29340	296	100510	174	106003	179	115309	179
29425	296	100511	174	106004	179	115310	179
29430	296	100599	149	106005	179	115315	179
29440	296	101040	175	106006	179	115320	179
29450	296	101045	175	106007	179	115325	179
29460	296	101050	175	106008	179	115327	179
30001	337	101055	175	106099	151	115330	179
32077-60	32	101060	175	106501	180	115340	179
32077-120	32	101070	175	106502	180	115399	151
38005	109	101080	175	106503	180	120004	177
47120	243	101090	175	106504	180	120005	177
47122	243	101100	175	106505	180	120006	177
47123	243	101110	175	106599	151	120007	177
47124	243	101120	175	107050	180	120008	177
47125	243	101130	175	107100	180	120010	177
90354	31	101503	175	107101	180	120011	177
90359	31	101504	175	107102	180	120099	150
90377	31	101505	175	107140	181, 308	123002	204
99045	156	101506	175	107151	180	123003	209
99046	156	101507	175	107155	181	123102	205
99049	312	101508	175	107330	181	123102-12	205
99067	351	101509	175	107331	182	123102-14	184
99068	318	101510	175	108000	183	123102-38	191
99073	110	101511	175	108100	183	130040	176
100035	174	101599	150	109060	182, 270	130045	176
100040	174	101990	149	109070	182, 270	130050	176
100045	174	102040	178	109080	182, 270	130055	176
100050	174	102055	178	109090	182, 270	130060	176
100055	174	102065	178	109100	182, 270	130070	176
100060	174	103001	178	109110	182, 270	130080	176
100070	174	103002	178	109150	182, 270	130090	176
100080	174	103003	178	109151	182, 271	130100	176
100090	174	104000	178	109175	183, 271	130110	176
100100	174	104001	178	110000	183	130120	176
100110	174	104002	178	115008	179	130130	176
100120	174	104003	178	115009	179	130140	176
100130	174	105008	178	115010	179	130990	149
100140	174	105010	178	115015	179	200060	185
100503	174	105015	178	115020	179	200070	185
100504	174	105020	178	115025	179	200080	185
100505	174	105025	178	115027	179	200090	185
100506	174	105027	178	115030	179	200100	185
100507	174	105030	178	115040	179	200110	185
100508	174	105040	178	115099	150	200120	185
100509	174	105099	150	115308	179	200130	185

INDEX / INDEX / INDICE

Art. No.	Cat.	Art. No.	Cat.	Art. No.	Cat.	Art. No.	Cat.
200140	185	201515	186	206010	189	300180	193
200150	185	201516	187	206099	153	300190	193
200160	185	201517	186	206501	189	300200	193
200170	185	201599	152	206502	189	300210	193
200180	185	201990	152	206503	189	300220	193
200190	185	201998	152	206504	189	300240	193
200200	185	202055	188	206505	189	300270	193
200210	185	202065	188	206507	189	300300	193
200220	185	202080	188	206509	189	300320	193
200240	185	203001	188	206599	153	300340	193
200505	185	203002	188	207075	190	301100	193
200507	185	203003	188	207076	190	301110	193
200509	185	204001	188	207150	190	301116	193
200510	185	204002	188	207151	190	301120	193
200511	185	204003	188	207152	190	301130	193
200512	185	205010	188	207250	190	301140	193
200513	185	205015	188	207251	190	301150	193
200514	185	205020	188	207252	190	301160	194
200515	185	205025	188	208000	191	301170	193
200516	185	205027	188	210000	191	301180	193
200517	185	205030	188	211516	192, 306	301190	193
200518	185	205040	188	212650	191	301210	194
200519	185	205045	188	213814	192	301220	193
200599	151	205050	188	220004	187	301990	154
201080	186	205055	188	220005	187	301998	155
201100	186	205060	188	220006	187	302055	300
201110	186	205099	153	220007	187	302065	300
201114	186	205310	189	220008	187	302080	300
201118	186	205315	189	220010	187	302100	300
201120	186	205320	189	220011	187	302120	300
201130	186	205325	189	220012	187	303001	300
201140	186	205327	189	220014	187	303002	300
201150	186	205330	189	220016	187	303003	300
201160	186	205340	189	220018	187	303004	300
201170	186	205345	189	220020	187	304001	300
201180	186	205350	189	220099	152	304002	300
201190	186	205355	189	300080	193	304003	300
201210	186	205360	189	300100	193	304004	300
201220	186	205399	153	300110	193	305010	301
201509	186	206003	189	300120	193	305015	301
201510	186	206004	189	300130	193	305020	301
201511	186	206005	189	300140	193	305025	301
201512	186	206006	189	300150	193	305027	301
201513	187	206007	189	300160	193	305030	301
201514	186	206008	189	300170	193	305040	301

Art. No.	Cat.	Art. No.	Cat.	Art. No.	Cat.	Art. No.	Cat.
305045	301	310000	205	320022	197	329099	157
305047	301	311340	207	320024	197	330100	194
305050	301	311380	207	320099	155	330110	194
305055	301	311516	207, 306	325010	198	330120	194
305060	301	313001	300	325015	198	330130	194
305070	301	313002	300	325020	198	330140	194
305080	301	313003	300	325025	198	330150	194
305090	301	314001	301	325027	198	330160	194
305100	301	314002	301	325030	198	330170	194
305310	302	315015	302	325040	198	330180	194
305315	302	315020	302	325045	198	330190	194
305320	302	315025	302	325050	198	330200	194
305325	302	315027	302	325055	198	330210	194
305327	302	315030	302	325060	198	330220	194
305330	302	315040	302	325070	198	330240	194
305340	302	315045	302	325099	155	330270	194
305345	302	315050	302	325380	199	330300	194
305350	302	315055	302	325381	199	330320	194
305355	302	315060	302	326005	200	330990	154
305360	302	315070	302	326006	200	330991	154
305370	302	315080	302	326007	200	335010	198
306003	303	315090	302	326008	200	335015	198
306004	303	315100	302	326010	200	335020	198
306005	303	315320	303	326012	200	335025	198
306006	303	315325	303	326014	200	335027	198
306007	303	315327	303	326017	200	335030	198
306008	303	315330	303	326099	156	335040	198
306010	303	315340	303	328005	201	335045	198
306012	303	315345	303	328006	201	335050	198
306014	303	315350	303	328008	201	335055	198
306501	304	315355	303	328010	201	335060	198
306502	304	315360	303	328012	201	335099	156
306503	304	316004	303	328014	201	335370	199
306504	304	316005	303	328016	201	336005	200
306505	304	316006	303	328099	157	336006	200
306507	304	316007	303	329005	202	336007	200
306509	304	316008	303	329006	202	336008	200
307125	203	316010	303	329007	202	336010	200
307126	203	316012	303	329008	202	336012	200
307127	204	320010	197	329009	202	336099	157
307250	203	320012	197	329010	202	338005	201
307251	203	320014	197	329011	202	338006	201
307252	204	320016	197	329012	202	338008	201
308000	205	320018	197	329013	202	338010	201
308001	205	320020	197	329014	202	338012	201

INDEX / INDEX / INDICE

Art. No.	Cat.	Art. No.	Cat.	Art. No.	Cat.	Art. No.	Cat.
338099	157	380320	195	385030	199	400002	164
339005	202	381000	206	385040	199	400002E	164
339006	202	381003	208	385045	199	400003	164
339007	202	381005	126	385050	199	400005	129
339008	202	381012	208	385055	199	400015	129
339009	202	381014	208	385060	199	400190	209
339010	202	381038	208	385070	199	400210	209
339011	202	381080	196	385080	199	400220	209
339012	202	381090	196	385090	199	400230	209
339013	202	381099	155	386003	200	400240	209
339014	202	381100	196	386004	200	400260	209
339099	158	381103	208	386005	200	400270	209
345330	199	381110	196	386006	200	400290	209
345340	199	381112	208	386007	200	400300	209
345345	199	381114	208	386008	200	400320	209
348005	304	381120	196	386009	200	400350	209
348006	304	381130	196	386010	200	400360	209
348008	304	381138	208	386012	200	400380	209
348010	304	381140	196	386014	200	400410	209
348012	304	381150	196	386016	200	400460	209
349005	304	381150-0	196	386017	200	400500	209
349006	304	381160	196	387125	204	407100	212
349008	304	381170	196	387200	171	407102	212
349010	304	381170-0	196	387998	206	407200	212
349012	304	381180	196	387999	206	407202	212
380005	126	381190	196	388004	201	407400	212
380080	195	381190-0	196	388005	201	407402	212
380090	195	381200	196	388006	201	408000	212
380100	195	381210	196	388008	201	408002	213
380110	195	381210-0	196	388009	201	411100	213
380120	195	381220	196	388010	201	411120	213
380130	195	381220-0	196	388012	201	480170	210
380140	195	381230	196	388014	201	480190	210
380150	195	381240	196	388016	201	480200	210
380160	195	381240-0	196	388018	201	480210	210
380170	195	381270	196	389004	203	480220	210
380180	195	381300	196	389005	203	480230	210
380190	195	381320	196	389006	203	480240	210
380200	195	381340	207	389007	203	480250	210
380210	195	381516	207	389008	203	480260	210
380220	195	385010	199	389009	203	480270	210
380230	195	385015	199	389010	203	480280	210
380240	195	385020	199	389012	203	480290	210
380270	195	385025	199	389013	203	480300	210
380300	195	385027	199	389014	203	480320	210













Art. No.	Cat.
480330	210
480340	210
480350	210
480360	210
480380	210
480410	210
480460	210
480500	210
481000	213
481170	211
481180	211
481190	211
481210	211
481220	211
481240	211
481260	211
481270	211
481290	211
481300	211
481320	211
481350	211
481360	211
481380	211
481410	211
481460	211
481500	211
483410	213
483412	214
487100	212
487200	212
500002	165









Art. No.	Cat.
500002E	165
500015	129
500360	214
500380	214
500410	214
500460	214
500500	214
500540	214
500550	214
500580	214
500600	214
500630	214
500650	214
500670	214
500700	214
500710	214
500750	214
500770	214
500800	214
507200	216
507400	216
508000	216
511340	216
581000	216
581034	216
581220	215
581240	215
581270	215
581300	215
581320	215
581330	215

Art. No.	Cat.
581340	215
581360	215
581380	215
581410	215
581460	215
581500	215
581550	215
581600	215
581650	215
581700	215
581750	215
581800	215
581850	215
581900	215
587200	216
590000	165
590035	177
590040	177
590045	177
590050	177
590055	177
590060	177
590070	177
590080	177
590090	177
590100	177
590110	177
590120	177
590130	177
591140	184
592760	184



Art. No.	Cat.
597075	181
600000	165
600100	187
600110	187
600120	187
600130	187
600140	187
600150	187
600160	187
600170	187
600180	187
600190	187
607075	190
610000	165
610190	197
610200	197
610210	197
610220	197
610240	197
610270	197
610300	197
610320	197
610340	197
611120	208
611140	192
611380	192
617075	204
617150	204

Technische Merkmale
Caractéristiques techniques
Caratteristiche tecniche

DIN	Gefertigt nach DIN-Spezifikationen <i>Fabriqu�e selon normes DIN</i> Prodotto secondo le norme DIN
ISO	Gefertigt nach ISO-Spezifikationen <i>Fabriqu�e selon normes ISO</i> Prodotto secondo le norme ISO
	TUV-GS - gepr�uft <i>Approuv� TUV-GS</i> Approvato TUV-GS
	Gewicht <i>Poids</i> Peso
	Vermassungen <i>Dimensions</i> Dimensioni
	Zoll-Größen <i>Dimensions en pouce</i> Dimensioni in pollici
	Pro Umdrehung <i>Par tour</i> Per rotazione
XXL	Extra lange Ausf�hrung <i>Mod�le extra-long</i> Tipo extra lungo
XS	Kurze Ausf�hrung <i>Mod�le court</i> Tipo corto
	Ratschenmechanismus, Anzahl Z�hne pro Umdrehung <i>M�chanisme de cliquet, quantit� de dents par tour</i> Meccanismo del cricchetto, numero di denti per giro
	Magnetisch <i>Magn�tique</i> Magnetico
	Gebrauch mit Schlagschraubern <i>A utiliser avec boulonneuse</i> Per uso a macchina
	Kabel <i>C�ble</i> Cavo elettrico
	Kupferdraht <i>Fil de cuivre</i> Filo elettrico
	Weichdraht <i>Fil souple</i> Filo di ferro
	Mittelharter Draht <i>Fil de fer semi-rigide</i> Cavo semirigido
	Hartdraht <i>Fil d�r</i> Filo duro

	Pianodraht <i>Corde � piano</i> Filo armonico
	Stahldraht <i>Fil d'acier</i> Filo di acciaio
	Verriegelung <i>Verrouillage</i> Sistema di chiusura
	Chrom-Vanadium <i>Chrome-Vanadium</i> Cromo-vanadio
	Chrom-Molybd�n <i>Chrome-Molybdenum</i> Cromo-molibdeno
	VDE-gepr�uft 110-250 V <i>Approuv� VDE 110-250V</i> Approvato VDE - 110-250V
	Fertigung/Pr�fung nach DIN/EN 60900 f�r Arbeiten unter Spannung bei AC 1000V und DC 1500V
	<i>Fabriqu�/approuv� selon DIN/EN 60900 pour travaux sous tension de AC 1000V et DC 1500V</i> Fabbricato/approvato sec. DIN/EN 60900 per lavorare su impianti in tensione da AC 1000V e DC 1500V
	S2 Werkzeugstahl (Chrom-Silizium-Mangan-Molybd�n-Vanadium-Stahl) <i>Acier pour outillage de qualit� S2</i> <i>(Acier Chrome-Silicium-Mangan�se Molybdenum-Vanadium)</i> Acciaio di qualit� S2 (acciaio al cromo-silicio-manganese-molibdeno-vanadio)
	ESD-Griffh�llen gegen Elektrostatik. Bieten keinen Schutz gegen elektrische Spannung! <i>Gaine ESD contre l'�lectricit� statique.</i> <i>N'offre pas de protection contre la tension �lectrique!</i> Impugnatura ESD contro l'elettro-staticit�. Non offre protezione contro la tensione elettrica!

Kaufm nnische Merkmale
Caract ristiques commerciales
Informazioni commerciali

	St�ck pro Artikel <i>Quantit� par article</i> Pezzi per articolo
	Best�ckungszahl <i>Nombre de pi�ces</i> Assortimento composto da

Modell nderungen sowie Verf gbarkeit vorbehalten.
Changements de mod les et disponibilit  r serv s.
Prodotto raffigurati, soggetti a possibili modifiche senza preavviso.

KRAFTWERK®

FAVORITE TOOLS SINCE 1979

KRAFTWERK Werkzeuge - stets ein zuverlässiger und robuster Partner

Les outils KRAFTWERK - des partenaires toujours fiables et robustes

Utensili KRAFTWERK - partner professionali robusti e affidabili



KRAFTWERK®

FAVORITE TOOLS SINCE 1979



Ihr Fachhändler: | *Votre distributeur spécialisé* : |
Il vostro rivenditore specializzato: